



# AF-6 Series Drives ED.02

Built-in features  
Built-in simplicity



GE imagination at work



## AF-6 Series Drives

---

- 2 Benefits
- 6 Inquiry customer data
- 8 AF-60 LP - Micro Drives**
  - 10 Options and accessories
  - 11 Basic wiring diagrams
  - 12 Technical specifications
  - 13 Dimensional drawings
- 14 AF-650 GP - General Purpose Drives**
  - 21 Options and accessoires
  - 24 Basic wiring diagrams
  - 25 Technical specifications
  - 27 Dimensional drawings
- 32 AF-600 FP - Fan and Pump Drives**
  - 39 Options and accessoires
  - 42 Basic wiring diagrams
  - 43 Technical specifications
  - 46 Dimensional drawings
- 51 Common Accessories**
  - 51 Harmonic filter
  - 52 dU/dt filter
  - 52 Sine-wave filter
  - 53 Dynamic braking resistors
- 56 Numerical index



## Highlight of benefits

### One family

- Designed for general purpose applications
- For both constant and variable torque applications
- Just one drive series to run an entire production line
- Broad range: 180W to 1.4 MW, 230 V – 690 V

### Designed for lifetime

- Built-in DC chokes increase the lifetime of the capacitors
- Conformal coating available

### Low operating costs

- Low energy consumption – up to 98% efficiency
- Less energy needed for cooling
- Automatic Energy Optimizer (AEO) potentially saves up to 5% energy compared to standard drives
- Low cost of ownership – no periodic maintenance/replacement cost
- Energy saving up to 40% depending on the application

## Constant torque applications Heavy Duty

Constant torque applications include those where the load does not change significantly with the speed as conveyors, lifting gear and mixers.

A motor block on a conveyor will always weight the same, regardless of whether the conveyor is running at low or high speed.

The torque required to move this motor block is always the same. Although friction and acceleration torques will vary depending on the operating state, the torque requirement for the load remains constant.

The power required by a system of this type is proportional to the torque required and to the speed of the motor.

Savings can be achieved directly if the speed can be reduced at constant load. Adapting the speed of the belt to the quantity of goods to be transported not only enables those goods to be processed without interruption but also leads to a reduction on the energy required.

Even if it is not possible or desirable to adapt the speed, most speed drives will still bring about reductions in energy consumption, since they regulate the motor's output voltage depending on load and as the load rises, it will increase the voltage.

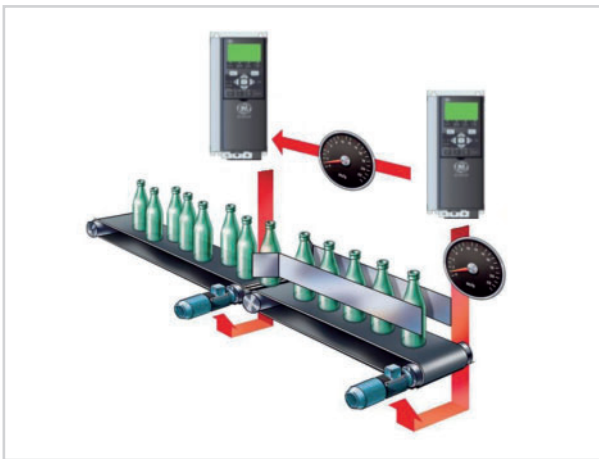

## Variable torque applications Light Duty

Often involve pumps and fans. However, a distinction has to be made in the case of pumps. Although the most popular types of centrifugal pump have a quadratic torque characteristic but eccentric, vacuum or positive displacement pumps have a constant torque characteristic. Pumps and fans have a significant share of all power consumed by industrial applications, with consumption levels approximately at 40%. Speed control is a simple yet very effective way of saving energy where fans and pumps with variable load torques are concerned.

Reducing the speed generates a cubic reduction in energy requirements. This significant potential for savings makes all applications with variable torque ideal candidates for the implementation of energy saving. Operators need to take into account that changes in speed alter the operating point and affect the efficiency. If the difference between the maximum power required and average part-load operation is too great, systems should be cascaded. It is often the case that investments pay for themselves relatively quickly when existing systems are converted.

## Built-in class A2 RFI filter

- Drive is ready to use and faults due to incorrect installation or wrong filter selection are avoided
- No over sizing of drive necessary – with motor cables of up to 300m, depending of the power rating of the drive
- Immunity from electrical interference and minimal emission
- Saves panel space and installation costs
- A1 and B1 filter also available as factory option
- Facilitates meeting CE EMC directives (requirement for EU markets)

## Built-in DC link reactor

- Low harmonic emission: THDi < 48%
- No voltage drop => full output voltage
- Reduces installation cost
- Fulfls EN 61000-3-2/3-12
- True power factor 0.9

## Reliable operation in harsh environment

- Protection against environmental pollution, aggressive gasses, moisture and dust
- Reduces the probability of failure resulting in less down-time
- Increases the lifetime of the drive
- High protection Class 3C2 **as standard** and increased protection in harsh environments with Class 3C3 **as optional**
- Optional conformal coating is tested to ANSI/ISA S71.04-1985 Class G3 (airborne gasses - harsh) and Class GX (airborne gasses - severe)

## Intelligent heat management

- Cooling fans are easily cleaned without touching the electronics
- 100% cooling air via segregated rear heat-sink– protects the electronic against aggressive environments
- Temperature controlled fan

## High immunity

- Immunity to fluctuating supply voltage (+/- 10%)
- Efficient overvoltage protection
- Fully short-circuit- and earth-leakage proof
- 100kA prospective short-circuit current capability

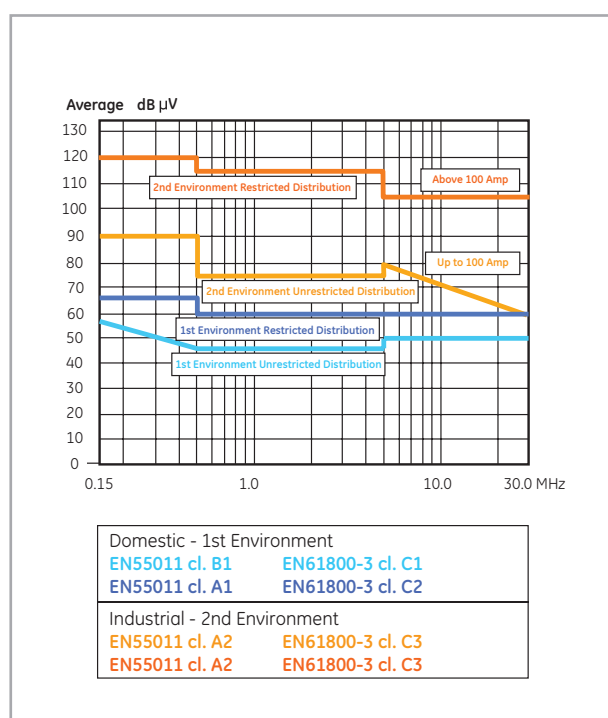

## AF-600 FP - Special pump functions

### No flow detection

- No flow detection is based on speed and power
- Two sets of data must be programmed into the drive
- Manual or auto set up
- Used to enable sleep mode in closed loop systems for energy savings

### End-of-curve protection

- If there is a water leak in the pipe, it will not produce pressure
- The pump is delivering a large volume of water but cannot maintain the static head
- Drive will go to full flow to try producing pressure (set point)
- The drive running at high speed with a feedback signal less than 97.5% of the set point pressure causes End of Curve action

### Dry pump protection

- Special no-flow condition, where pressure can not be produced, if there is no water
- Drive will go to full speed to try producing full pressure
- Low power consumption at high speed causes Dry Pump action



## PC software tool DCT-10

One PC tool for all tasks

- Explorer-like view
- On and offline commission
- Help description for each drive parameter
- Oscilloscope function
- Option programming
- Logging of alarms and warnings for improved system performance and documentation

Interacts with process management

Communicates through USB, RS485 or Network

## Plug-in option modules

- Tailored for specific application needs
- Low handling cost
- Easy service/ upgrade with a wide range of options
- Field installable Plug n' Play and self configuring



- 1 A slot : Network option modules
- 2 B slot : I/O option modules
- 3 24Vdc External supply option module

## Control wiring and PC connections

- Reduced installation time - Pluggable terminal block for easy installation
- Improved installation quality
- Spring terminals provide better contact than screw terminals
- Thin or thick wires (1.5mm<sup>2</sup> solid/1.0mm<sup>2</sup> stranded wire)

## Built-in control card I/O

### Inputs / Outputs

- 6 digital I/O (0-24Vdc)
  - 2 configurable as Digital Outputs
  - 2 configurable as Pulse I/O
  - Configurable as PNP or NPN
- 2 form C relay outputs with on/off delays
- 2 analogue Input (0-10V or 0/4-20mA)
- 1 analogue Output (0/4-20mA)

### Serial ports

- RS 485 Port
  - Supports multi-drop connections
  - Supports 1.2 km cables
  - Switchable network termination
  - Modbus RTU
- USB Port
  - Simple USB direct cable connection ~3m max.
  - Point - to - point

## Network option modules

- Support for all leading protocols
- Easy installation and commissioning
  - Top cable entry -or-
  - Bottom cable entry (if used you cannot add I/O option modules)
- Built-in Networks: Modbus RTU

Only for AF650 GP and AF600 FP

- Network option modules: Profibus DP, DeviceNet, Ethernet IP, Modbus TCP, Profinet RT
- Additional Option Modules for AF-600 FP: BACnet and LonWorks



### Inquiry customer data for dimensioning of variable speed drives

**Nominal Motor Data (Type Plate)**

Motor Type :	Manufacturer:		
Nominal Power P <sub>n</sub> :	kW		
Nominal Voltage U <sub>n</sub> (Y/Δ):	V	Nominal Current I <sub>N</sub> (Y/Δ):	A
Nominal Speed:	min <sup>-1</sup>	cos φ	
Specifications:			
<b>Grid Voltage:</b>	Grid Type (IT/TT/TN):		
Length of Motorcable:	Degree of EMC :		
Application Area (Industry / Residential) :			
Special Exigencies:			

**Application Description:**

---



---



---



---

Torque characteristics (Constant/Quadratic):

Overload (110/160%):

Speed Range:

Braking Torque:

Desired Functionalities:

---



---



---



---

Specification:

---



---



---



---

**Communication System:**

<b>Protection Degree:</b>	IP	Special Ambient Conditions
---------------------------	----	----------------------------





Notes

Grid of dots for notes.





## AF-60 LP - Micro Drives

The Micro Drive AF-60 LP is a compact but powerful and easy to use AC variable frequency drive.

The drive is available in its standard configuration that includes built-in Brake chopper for 1.5kW and above, single-turn potentiometer for speed reference and LCD keypad display that can be remotely mounted.

Following models are available:

- Single-phase, 230Vac, from 0.18 to 2.2kW
- Three-phase, 230Vac, from 0.25 to 3.7kW
- Three-phase, 400Vac, from 0.37 to 22kW

### Features

#### Ready to start from the beginning

- Self-protecting features
- 150% current overload up to 1 minute
- "Pick up" start (catch a spinning motor)
- Potentiometer on keypad
- Keypad is hot pluggable and can be password protected
- RS485 communication, Modbus protocol
- RFI class A1 filter built-in
- Dynamic brake incorporated from 1,5kW
- High level functions, PID for feedback systems, mechanical brake control for lifts
- Easy to use PC software
- Integrated logic control, PLC

#### Built-in durability

- Robust housing (IP20) protects the drive and allows side-by-side mounting
- Conformal coated circuit boards and high quality capacitors maximize uptime
- Intelligent heat management leads to long life

#### Built-in simplicity speeds installation and set-up

- Installation and set-up immediate
- Wiring diagram, template and quick guide
- DIN-rail kit optional, to 2.2kW (unit size M1 and M2)

### Approvals / Marking



UL, cUL, C-Tick

### Applications

- Fans
- Pumps
- Mixers
- Conveyors
- Material handling
- Industrial machinery, including: agitators, lathes, spinning machines, machine tools, packaging equipment, plastics and woodworking

### Product numbering system diagram

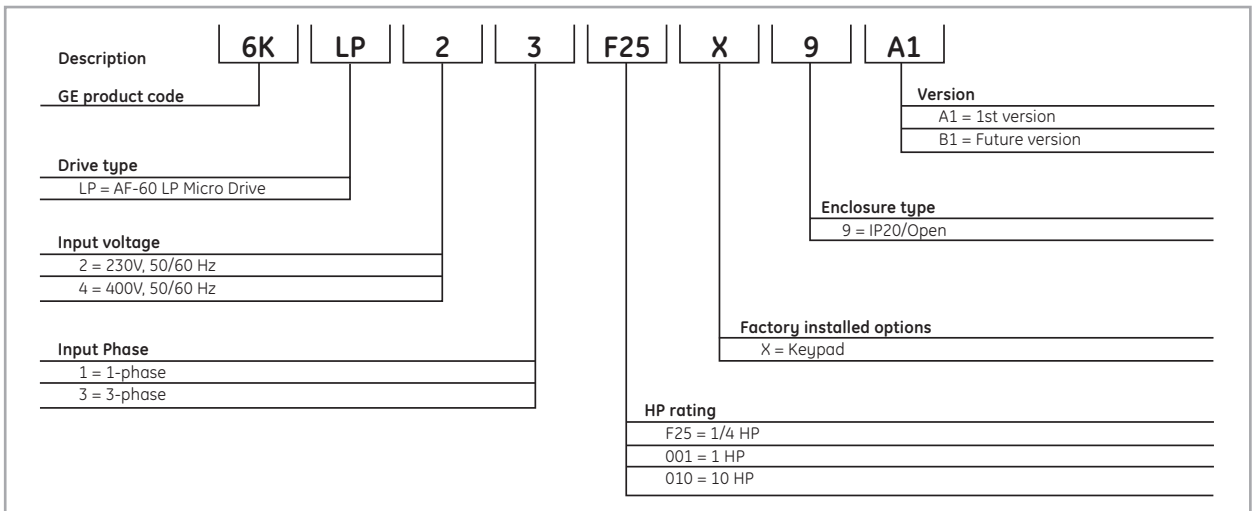

Product number for illustrative purposes only



**IP20****230 Vac, 1-phase, 50/60 Hz input**

Nominal motor ratings		Cat. No.	Ref. No.	Unit Size	Efficiency (%) <sup>(1)</sup>	Losses (W) <sup>(1)</sup>	IP21 kit	DIN-rail mounting kit
Power kW	Current A							
0.18	1.2	6KLP21F25X9A1	404774	M1	94.5	15.5	NEMA1ACLP1	RMACLP1
0.37	2.2	6KLP21F50X9A1	404775	M1	95.6	25.0	NEMA1ACLP1	RMACLP1
0.75	4.2	6KLP21001X9A1	404776	M1	96.0	44.0	NEMA1ACLP1	RMACLP1
1.5	6.8	6KLP21002X9A1	404777	M2	96.7	67.0	NEMA1ACLP2	RMACLP1
2.2	9.6	6KLP21003X9A1	404778	M3	97.1	85.1	NEMA1ACLP3	N/A

**230 Vac, 3-phase, 50/60 Hz input**

0.25	1.5	6KLP23F33X9A1	404779	M1	94.9	20.0	NEMA1ACLP1	RMACLP1
0.37	2.2	6KLP23F50X9A1	404780	M1	95.8	24.0	NEMA1ACLP1	RMACLP1
0.75	4.2	6KLP23001X9A1	404781	M1	96.3	39.5	NEMA1ACLP1	RMACLP1
1.5	6.8	6KLP23002X9A1	404782	M2	97.2	57.0	NEMA1ACLP2	RMACLP1
2.2	9.6	6KLP23003X9A1	404783	M3	97.4	77.1	NEMA1ACLP3	N/A
3.7	15.2	6KLP23005X9A1	404784	M3	97.4	122.8	NEMA1ACLP3	N/A

**400 Vac, 3-phase, 50/60 Hz input**

0.37	1.2	6KLP43F50X9A1	404785	M1	95.5	25.5	NEMA1ACLP1	RMACLP1
0.75	2.2	6KLP43001X9A1	404786	M1	96.0	43.5	NEMA1ACLP1	RMACLP1
1.5	3.7	6KLP43002X9A1	404787	M2	97.2	56.5	NEMA1ACLP2	RMACLP1
2.2	5.3	6KLP43003X9A1	404788	M2	97.1	81.5	NEMA1ACLP2	RMACLP1
4	9	6KLP43005X9A1	404789	M3	98.0	133.5	NEMA1ACLP3	N/A
5.5	12	6KLP43007X9A1	404790	M3	98.0	166.8	NEMA1ACLP3	N/A
7.5	15.5	6KLP43010X9A1	404791	M3	98.0	217.5	NEMA1ACLP3	N/A
11	23	6KLP43015X9A1	404792	M4	97.4	342	NEMA1ACLP4	N/A
15	31	6KLP43020X9A1	404793	M4	97.4	454	NEMA1ACLP4	N/A
18.5	37	6KLP43025X9A1	404794	M5	98.0	428	NEMA1ACLP5	N/A
22	43	6KLP43030X9A1	404795	M5	97.9	520	NEMA1ACLP5	N/A

Brake chopper is included with 1.5kW drives and above

(1) At rated load conditions

## Options and accessories

### Remote mounting kit for keypad



Remote mounting kit for mounting keypad on enclosure doors.  
Kit includes gasket, mounting brackets, and cable. Keypad is rated IP21.

Description	Cat. No.	Ref. No.
Remote mounting kit for keypad cable (3m)	RMKYPDACLP1	404797

### DIN-rail mounting kit

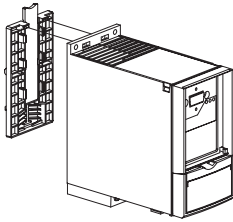

This adapter can be used to mount AF-60 LP Micro Drives at 0.75kW and below to 35mm DIN-rail.

Description	Cat. No.	Ref. No.
DIN-rail mounting kit for unit size M1 or M2 <sup>(1)</sup>	RMACLP1	404806

(2) Please note that these DIN-rail mounting kits only include bottom cover.

### IP21 kit

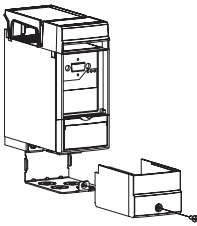

This kit can be mounted to the IP20 protected AF-60 LP Micro Drives to provide IP21 protection.

Description	Cat. No.	Ref. No.
For 0.75kW and below drives (unit size M1)	NEMA1ACL1	404798
For 1.5kW at 230V, 2.2kW at 400V and below drives (unit size M2)	NEMA1ACL2	404799
For 2.2kW at 230V, 3.7kW at 400V and above drives (unit size M3)	NEMA1ACL3	404800
For 11kW and 15kW at 400V drives (unit size M4)	NEMA1ACL4 <sup>(2)</sup>	404801
For 18.5kW and 22kW at 400V drives (unit size M5)	NEMA1ACL5 <sup>(2)</sup>	404802

(2) Please note that these IP21 kits only include bottom cover.

### De-coupling plate kit

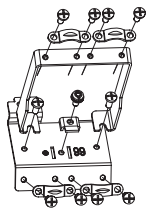

For EMC applications and strain relief for drive wiring.

Description	Cat. No.	Ref. No.
For 1.5kW at 230V, 2.2kW at 400V and below drives (unit size M1 and M2)	DEPLTACL1	404804
For 2.2kW at 230V, 3.7kW at 400V and above drives (unit size M3)	DEPLTACL2	404805
For 11kW at 400V and above drives (unit size M4 and M5)	DEPLTACL3	404803

Basic wiring diagrams

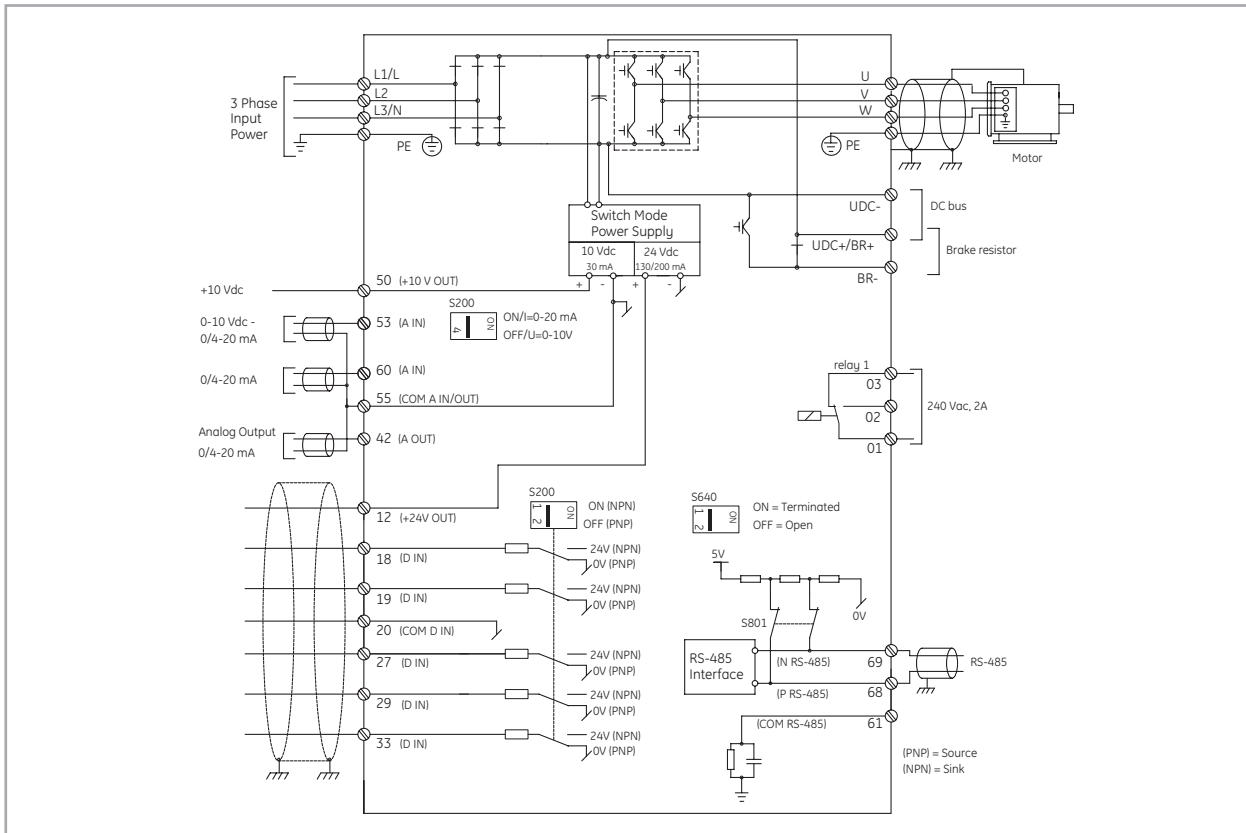

Basic control terminal (PNP configuration and drive factory default settings)

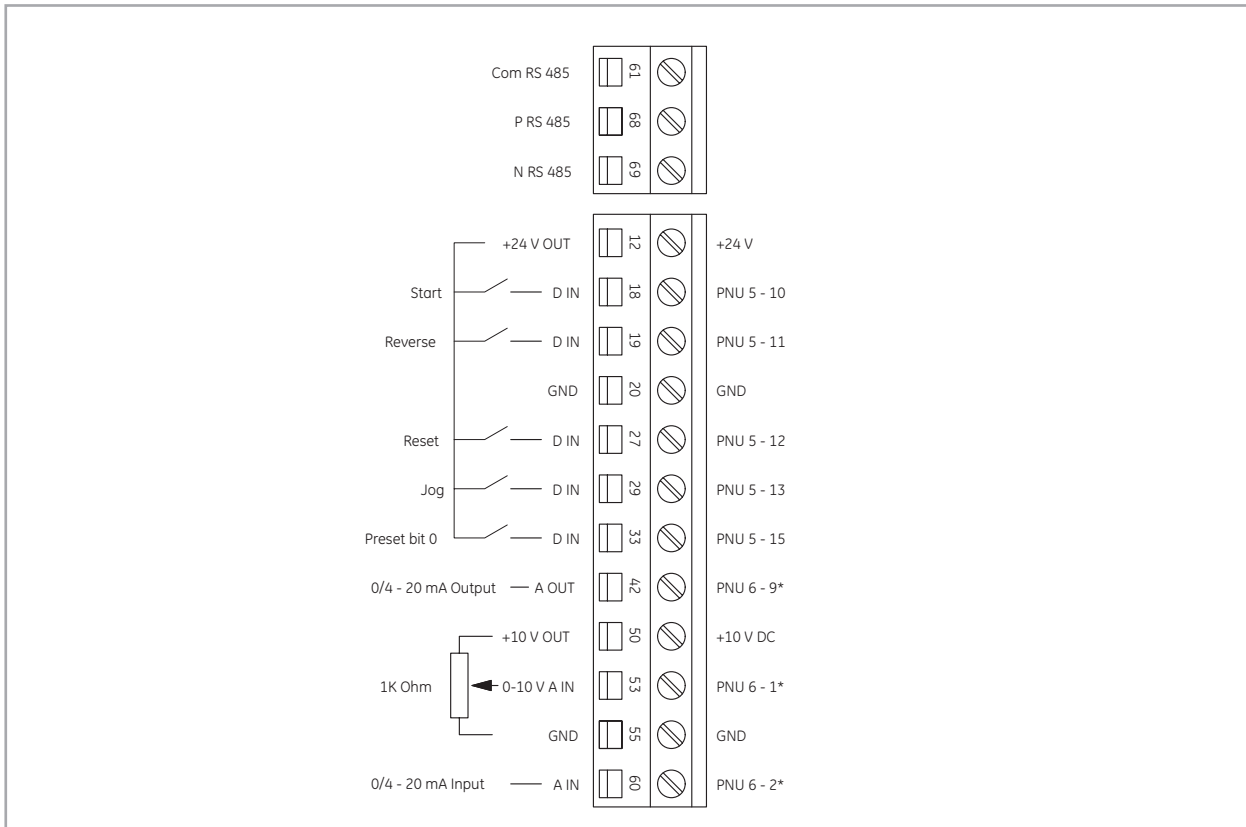

## Specifications

### Environmental conditions

Enclosure	IP20 (IP21 with optional kit)
Installation location	For use at altitudes of (1000m) or less without derating.
Ambient temperature	-10° to +50° C for above 45°C, there will be derating; please consult GE
Ambient humidity	5 to 95% RH (non-condensing)
Vibration	1.0G
Storage temperature	-25° to 65° C

### Standards

Approvals	CE, UL, cUL, and C-Tick Suitable for use on a circuit capable of delivering not more than 100,000 rms symmetrical amperes for 230V and 400V. WEEE and RoHS Compliant
-----------	--

### Input power supply

Rated Input AC voltage	200-240 Vac, 1-phase, 50-60 Hz, +/- 10% V 200-240 Vac, 3-phase, 50-60 Hz, +/- 10% V 380-480 Vac, 3-phase, 50-60 Hz, +/- 10% V
Maximum voltage imbalance	3% of rated supply voltage
True power factor	> 0.4 nominal at rated load
Displacement power factor	> 0.98
Switching on input power supply	Maximum twice/minute
Environment according to EN60664-1	Overvoltage category III/pollution degree 2

### Output

Rated output voltage	0-100% of supply voltage
Output frequency	0-200Hz (Adv. Vector Control Plus Mode), 0-400 Hz (Volts/Hertz Mode)
Switching on output	Unlimited
Accel/decel times	0.05-3600 seconds
Overload current rating	150% of drive rated current for 1 minute

### Control

Control method	Sinusoidal PWM Control (V/Hz with torque vector control)
Switching frequency select	2, 4, 8, 12, 16 kHz
Operation method	Keypad operation: Hand, Off, Auto Digital Input: Programmable for Start/Stop, Forward/Reverse, Jog Timer operation: Stop after predetermined time frame Link operation: RS-485 Modbus RTU
Frequency reference setting	Up or Down buttons on keypad or external reference
Analog input	Built in potentiometer 0-10 Vdc analogue input 4-20 mA analogue input
Preset speeds	8 presets via digital inputs
Link operation	Drive RS-485 or Modbus RTU
Second reference setting	Switch from speed reference 1 to reference 2 via digital input
Trim reference setting	Available for speed reference offset via potentiometer, voltage input, or current input
Acceleration/deceleration time	0.05-3600 seconds (two acceleration and deceleration rates are selectable via digital inputs. Acceleration and deceleration patterns can be selected from linear or S-curve)
DC injection braking	Starting frequency: 0.0-400 Hz Braking level: 0-150% of rated current Braking time: 0.0-60.0 seconds
Frequency limit	0-400 Hz
Jump frequency control	Two jump (or skip) frequencies via parameter set to avoid mechanical vibration
Jogging operation	Operation via On key or digital input (Fwd or Rev)
Auto-restart after power failure	Restarts the drive without stopping after instantaneous power failure
Slip compensation	Maintains motor at constant speed with load fluctuations
Energy savings	Controls output voltage to minimize motor loss during constant speed operation
Start mode function	This functionality smoothly catches a spinning motor

### Logic controller (LC)

Logic controller events	Over 23 types of programmable events
Comparators	Array of 4 comparators
Timers	Array of 3 timers, adjustable from 0.0 to 3600 sec
Logic rules	Array of 4 boolean logic rules
Logic controller states	Array of 20 logic controller action states

### Process controller (PID)

Feedback select	No function, analogue input 1, analogue input 2, pulse input, local bus reference
Control	Normal or inverse
Anti windup	Disabled or enabled
Start speed	0.0-200 Hz
Proportional gain	0.00-10.00
Integral gain	0.10-9999 seconds
Feed forward factor	0-400%
On reference bandwidth	0-200%

### Indication

LEDs	Green - drive is on Yellow - indicates a warning Red - indicates an alarm
Monitor Units Available	Frequency, current, voltage, power, horsepower, % load, speed, or time

### Trip codes

2	Live zero error
4	Line phase loss
7	DC overvoltage
8	DC undervoltage
9	Drive overload
10	Motor overtemperature
11	Motor thermistor overtemperature
12	Torque limit
13	Overcurrent
14	Ground fault
16	Short circuit
17	Control word timeout
25	Brake resistor short-circuited
27	Brake chopper short-circuited
28	Brake check
29	Power board overtemperature
30	Missing U phase
31	Missing V phase
32	Missing W phase
38	Internal fault
47	Control voltage fault
51	Auto tune check - wrong motor parameters
52	Auto tune low inom - motor current is too low
59	Current limit
63	Mechanical brake low
80	Drive restored to factory settings

### Monitoring parameters available

Power	kW
Power	HP
Motor voltage	V
Frequency	Hz
Motor current	A
Frequency	%
Motor thermal	%
DC link voltage	V
Drive current	A
Drive max current	A
Logic controller state	ON/OFF



## Dimensional drawings

### Micro drives

Unit size	Nominal motor power ratings (kW)			Height (mm)			Width (mm)		Depth (mm)	Weight
	230 V 1ph	230 V 3ph	400 V 3ph	A	A (including decoupling plate)	a	B	b	C	kg
M1	0.18 - 0.75	0.25 - 0.75	0.37 - 0.75	150	205	140.4	70	55	148	1.1
M2	1.5	1.5	1.5 - 2.2	176	230	166.4	75	59	168	1.6
M3	2.2	2.2 - 3.7	4 - 7.5	239	294	226	90	69	194	3.0
M4	-	-	11 - 15	292	347.5	272.4	125	97	249	6.0
M5	-	-	18.5 - 22	335	387.5	315	165	140	256	9.5

### Micro drive keypad

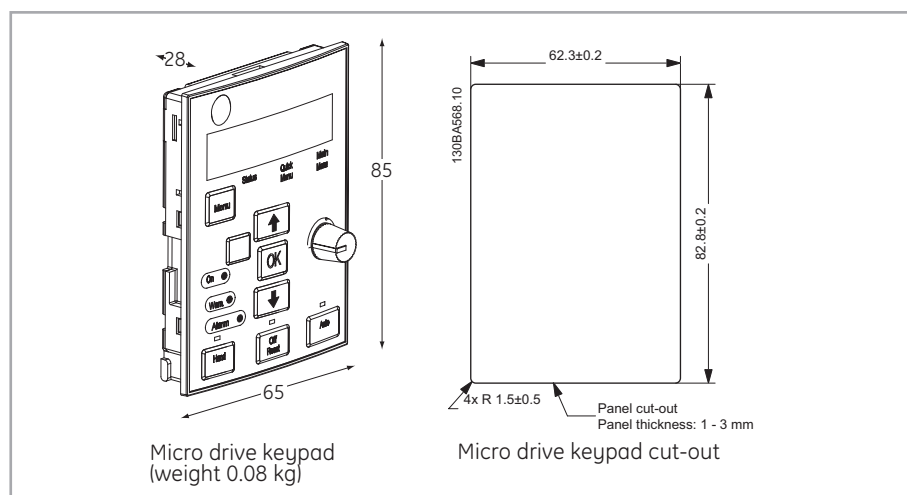
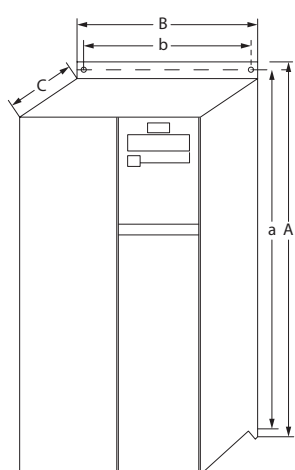

Micro drive keypad (weight 0.08 kg)

Micro drive keypad cut-out

Note: Please allow 5 cm between drives with field installed IP21 kits. Also, please consult the relevant AF-6 Series drives Operating Instructions for recommended clearance above and below each drive rating.

### DIN-rail mounting kit for 0.75kW and below drives (unit size M1 and M2)

Cat. No.	Ref. No.	A (mm)	B (mm)	C (mm)
RMACLP1	404806	60	129	13.5

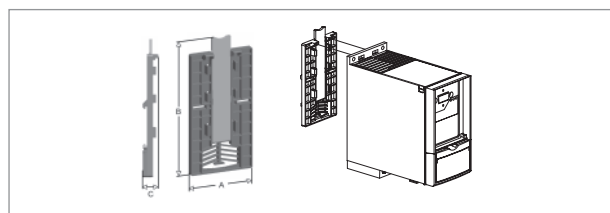

### IP21 field installed kit – top

Cat. No.	Ref. No.	A (mm)	B (mm)	C (mm)	D (mm)
NEMA1ACLP1	404798	72	43	151	8
NEMA1ACLP2	404799	77	43	172	8
NEMA1ACLP3	404800	92	43	199	8

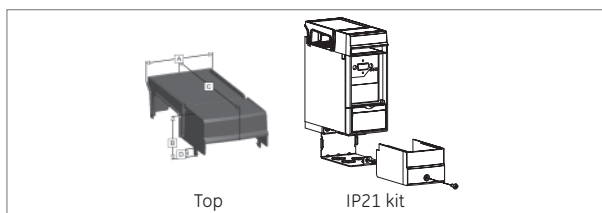

### De-coupling plate kit

Cat. No.	Ref. No.	A (mm)	B (mm)	C (mm)	D (mm)	E (mm)
DEPLTACL1	404804	70	52	100	14	22.6
DEPLTACL2	404805	70	52	N/A	14	22.6

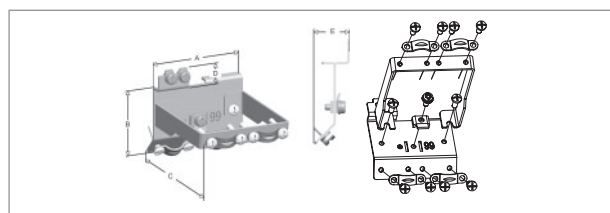

### IP21 field installed kit – bottom

Cat. No.	Ref. No.	A (mm)	B (mm)	C (mm)	D (mm)
NEMA1ACL1	404798	70	55	107	8
NEMA1ACL2	404799	75	55	114	8
NEMA1ACL3	404800	90	55	121	8

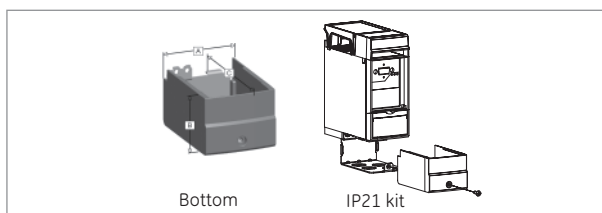



## AF-650 GP - General Purpose Drives

The AF-650 GP general purpose drive is a powerful, flexible and easy to use drive with many standard features. It is ideally suited for both heavy duty and light duty applications.

The drive is available in its standard configuration that includes IP20 or IP00 chassis, LCD keypad display that can be remote mounted, DC link reactors, built-in Modbus RTU and RFI class A2 filter. Available in IP 55 and IP 66 enclosures.

Following models are available:

- Three-phase, 230Vac, from 0.25 to 45kW
- Three-phase, 400Vac, from 0.37 to 1000kW
- Three-phase, 690Vac, from 11 to 1200kW

### Features

- Self-protecting features
- Other available configurations: RFI class A1/B1 filter, braking chopper and conformal coating.
- Configurations are available in IP55 and IP66
- RFI class A2 filter and DC link reactor as standard configuration
- Duality of power, Heavy or Light Duty
- 150% current overload for 1 minute (Heavy Duty)
- 110% current overload for 1 minute (Light Duty)
- Hot pluggable, illuminated LCD display, unit indications, rotation direction indication, trended charts display speed, torque, current, full alarm messages & descriptions
- Speed and process PID controls
- Integrated logic control, PLC
- "Pick up" start (catch a spinning motor)
- Precise stop function
- Safe Stop/Safe Torque function built-in (SIL 2)
- Advanced brake control
- 24V encoder feedback built-in
- Easy to use PC software
- Built-in communication networks for ModBus RTU
- Optional protocols: Profibus DP, Profinet, ModBus TPC/IP, Ethernet/IP and DeviceNet
- High standard protection class 3C2, optional class 3C3

### Approvals / Marking



UL, cUL, C-Tick

### Applications

Conveyors, mixers, agitators, lathes, spinning machines, machine tool, grinder, extruders, plastic injection molding machines, constant displacement pumps, woodworking machines.

### Product numbering system diagram

Description	<b>6K</b>	<b>GP</b>	<b>2</b>	<b>3</b>	<b>F50</b>	<b>X</b>	<b>2</b>	<b>R</b>	<b>B</b>	<b>C</b>	<b>A1</b>
<b>GE Product code</b>											
<b>Drive type</b>											
GP = AF-650											
General purpose drive											
<b>Input voltage</b>											
2 = 230V, 50/60 Hz											
4 = 400V, 50/60 Hz											
6 = 690V, 50/60 Hz											
<b>Input phase</b>											
3 = 3-phase											
<b>HP rating</b>											
F50 = 1/2 HP											
010 = 10 HP											
100 = 100 HP											
1K0 = 1000 HP											
<b>Version</b>											
A1 = 1st version											
B1 = 2nd version											
C1 = Future version											
<b>Conformal coating</b>											
X = No Conformal coatings											
C = Conformal coatings											
<b>Brake chopper</b>											
X = No factory installed brake chopper											
B = Factory installed brake chopper											
<b>RFI filter</b>											
X = Only A2 RFI filter											
R = A1/B1 RFI filter installed											
<b>Enclosure type</b>											
1 = IP21/NEMA 1											
2 = IP55/NEMA 12											
4 = IP66/NEMA 4											
9 = IP20/open											
8 = IP00/open											
<b>Factory installed keypad</b>											
X = Keypad											

Product number for illustrative purposes only





IP00 / IP20 / IP21, with EMC filter Class A2 (C3)

230V, 3-phase, 50/60Hz input

Heavy Duty rating Nominal motor ratings			Light Duty rating Nominal motor ratings			Enclosure type <sup>(1)</sup> :	WITH braking chopper		WITHOUT braking chopper		Unit size	
Power kW	Current A	Overload current during 60s (A)	Power kW	Current A	Overload current during 60s (A)		Cat. No.	Ref. No.	Cat. No.	Ref. No.		
0.25	1.8	2.88	0.25	1.8	2.88	IP20	6KGP23F33X9XBXA1		6KGP23F33X9XXXXA1	404670	12	
0.37	2.4	3.84	0.37	2.4	3.84		6KGP23F50X9XBXA1		6KGP23F50X9XXXXA1	404671	12	
0.75	4.6	7.36	0.75	4.6	7.36		6KGP23001X9XBXA1		6KGP23001X9XXXXA1	404672	12	
1.5	7.5	12	1.5	7.5	12		6KGP23002X9XBXA1		6KGP23002X9XXXXA1	404673	12	
2.2	10.6	16.96	2.2	10.6	16.96		6KGP23003X9XBXA1		6KGP23003X9XXXXA1	404674	12	
3.7	16.7	26.72	3.7	16.7	26.72		6KGP23005X9XBXA1		6KGP23005X9XXXXA1	404675	13	
5.5	24.2	38.72	5.5/7.5	30.8	33.88		6KGP23007X9XBXA1		6KGP23007X9XXXXA1	404676	23	
7.5	30.8	49.28	11	46.2	50.82		6KGP23010X9XBXA1		6KGP23010X9XXXXA1	404677	23	
11	46.2	73.92	15	59.4	65.34		6KGP23015X9XBXA1		6KGP23015X9XXXXA1	404678	24	
15	59.4	89.1	18.5	74.8	82.28		6KGP23020X9XBXA1		6KGP23020X9XXXXA1	404679	24	
18.5	74.8	112.2	22	88	96.8		6KGP23025X9XBXA1		6KGP23025X9XXXXA1	404680	33	
22	88	132	30	115	126.5		6KGP23030X9XBXA1		6KGP23030X9XXXXA1	404681	33	
30	115	172.5	37	143	157.3		6KGP23040X9XBXA1		6KGP23040X9XXXXA1	404682	34	
37	143	214.5	45	170	187		6KGP23050X9XBXA1		6KGP23050X9XXXXA1	404683	34	

400V, 3-phase, 50/60Hz input

Heavy Duty rating Nominal motor ratings			Light Duty rating Nominal motor ratings			Enclosure type <sup>(1)</sup> :	WITH braking chopper		WITHOUT braking chopper		Unit size
Power kW	Current A	Overload current during 60s (A)	Power kW	Current A	Overload current during 60s (A)		Cat. No.	Ref. No.	Cat. No.	Ref. No.	
0.37	1.3	2.08	0.37	1.3	1.43	IP20	6KGP43F50X9XBXA1	403116	6KGP43F50X9XXXXA1	400412	12
0.75	2.4	3.84	0.75	2.4	2.64		6KGP43001X9XBXA1	403117	6KGP43001X9XXXXA1	400451	12
1.5	4.1	6.56	1.5	4.1	4.51		6KGP43002X9XBXA1	403118	6KGP43002X9XXXXA1	401212	12
2.2	5.6	8.96	2.2	5.6	6.16		6KGP43003X9XBXA1	403119	6KGP43003X9XXXXA1	401362	12
4	10	16	4	10	11		6KGP43005X9XBXA1	403120	6KGP43005X9XXXXA1	402735	12
5.5	13	20.8	5.5	13	14.3		6KGP43007X9XBXA1	403121	6KGP43007X9XXXXA1	402738	13
7.5	16	25.6	7.5	16	17.6		6KGP43010X9XBXA1	403122	6KGP43010X9XXXXA1	402746	13
11	24	38.4	11/15	32	35.2		6KGP43015X9XBXA1	403123	6KGP43015X9XXXXA1	402747	23
15	32	51.2	18.5	37.5	41.25		6KGP43020X9XBXA1	403124	6KGP43020X9XXXXA1	402748	23
18.5	37.5	60	22	44	48.4		6KGP43025X9XBXA1	403125	6KGP43025X9XXXXA1	402765	24
22	44	70.4	30	61	67.1		6KGP43030X9XBXA1	403126	6KGP43030X9XXXXA1	402766	24
30	61	97.6	37	73	80.3		6KGP43040X9XBXA1	403127	6KGP43040X9XXXXA1	402767	24
37	73	116.8	45	90	99		6KGP43050X9XBXA1	403128	6KGP43050X9XXXXA1	402768	33
45	90	144	55	106	116.6		6KGP43060X9XBXA1	403129	6KGP43060X9XXXXA1	402769	33
55	105	168	75	147	161.7		6KGP43075X9XBXA1	403130	6KGP43075X9XXXXA1	402857	34
75	147	235.2	90	177	194.7		6KGP43100X9XBXA1	403131	6KGP43100X9XXXXA1	402863	34
90	177	265.5	110	212	233.2		6KGP43125X9XBCB1	409619	6KGP43125X9XXCB1	409600	43h
110	212	318	132	260	286		6KGP43150X9XBCB1	409620	6KGP43150X9XXCB1	409601	43h
132	260	390	160	315	346.5		6KGP43200X9XBCB1	409621	6KGP43200X9XXCB1	409602	43h
160	315	472.5	200	395	434.5	6KGP43250X9XBCB1	409622	6KGP43250X9XXCB1	409603	44h	
200	395	592.5	250	480	528	6KGP43300X9XBCB1	409623	6KGP43300X9XXCB1	409604	44h	
250	480	720	315	588	647	6KGP43350X9XBCB1	409624	6KGP43350X9XXCB1	409605	44h	
315	600	900	355	658	723.8	6KGP43450X8XBCA1	403138	6KGP43450X8XXCA1	402870	52	
355	658	987	400	745	819.5	6KGP43500X8XBCA1	403139	6KGP43500X8XXCA1	402871	52	
400	745	1117.5	450	800	880	6KGP43550X8XBCA1	403140	6KGP43550X8XXCA1	402872	52	
450	800	1200	500	880	968	6KGP43600X1XBCA1	403141	6KGP43600X1XXCA1	402873	61	
500	880	1320	560	990	1089	6KGP43650X1XBCA1	403142	6KGP43650X1XXCA1	402874	61	
560	990	1485	630	1120	1232	6KGP43750X1XBCA1	403143	6KGP43750X1XXCA1	402875	61	
630	1120	1680	710	1260	1386	6KGP43900X1XBCA1	403144	6KGP43900X1XXCA1	402876	61	
710	1260	1890	800	1460	1606	6KGP431K0X1XBCA1	403145	6KGP431K0X1XXCA1	402877	62	
800	1460	2190	1000	1700	1870	6KGP431K2X1XBCA1	403146	6KGP431K2X1XXCA1	402878	62	

690V, 3-phase, 50/60Hz input

Heavy Duty rating Nominal motor ratings			Light Duty rating Nominal motor ratings			Enclosure type:	WITH braking chopper		WITHOUT braking chopper		Unit size
Power kW	Current A	Overload current during 60s (A)	Power kW	Current A	Overload current during 60s (A)		Cat. No.	Ref. No.	Cat. No.	Ref. No.	
11	13	20.8	15	18	20	IP21 conformal coated	6KGP63015X1XBCA1	403795	6KGP63015X1XXCA1	403741	22
15	18	28.8	18.5	22	24		6KGP63020X1XBCA1	403796	6KGP63020X1XXCA1	403742	22
18.5	22	35.2	22	27	30		6KGP63025X1XBCA1	403797	6KGP63025X1XXCA1	403743	22
22	27	43.2	30	34	37		6KGP63030X1XBCA1	403798	6KGP63030X1XXCA1	403744	22
30	34	51	37	41	45		6KGP63040X1XBCA1	403799	6KGP63040X1XXCA1	403745	32
37	41	61.5	45	52	56		6KGP63050X1XBCA1	403800	6KGP63050X1XXCA1	403746	32
45	52	76.5	55	62	68		6KGP63060X1XBCA1	403801	6KGP63060X1XXCA1	403747	32
55	62	93	75	83	91		6KGP63075X1XBCA1	403802	6KGP63075X1XXCA1	403748	32
75	83	124.5	90	100	110		6KGP63100X1XBCA1	403803	6KGP63100X1XXCA1	403749	32
90	108	162	110	131	144		6KGP63125X9XBCB1	409665	6KGP63125X9XXCB1	409651	43h
110	131	196.5	132	155	171		6KGP63150X9XBCB1	409666	6KGP63150X9XXCB1	409652	43h
132	155	232.5	160	192	211		6KGP63200X9XBCB1	409667	6KGP63200X9XXCB1	409653	43h
160	192	288	200	242	266		6KGP63250X9XBCB1	409668	6KGP63250X9XXCB1	409654	44h
200	242	363	250	290	319		6KGP63300X9XBCB1	409669	6KGP63300X9XXCB1	409655	44h
250	290	435	315	344	378		6KGP63350X9XBCB1	409670	6KGP63350X9XXCB1	409656	44h
315	344	516	400	400	440		6KGP63450X9XBCB1	409671	6KGP63450X9XXCB1	409657	44h
355	380	570	450	450	495		6KGP63500X8XBCA1	403658	6KGP63500X8XXCA1	403561	52
400	410	615	500	500	550		6KGP63550X8XBCA1	403659	6KGP63550X8XXCA1	403562	52
500	500	750	560	570	627		6KGP63650X8XBCA1	403660	6KGP63650X8XXCA1	403563	52
560	570	855	630	630	693	6KGP63750X8XBCA1	403661	6KGP63750X8XXCA1	403564	52	
630	630	945	710	730	803	6KGP63900X1XBCA1	403662	6KGP63900X1XXCA1	403565	61	
710	730	1095	800	850	935	6KGP631K0X1XBCA1	403663	6KGP631K0X1XXCA1	403566	61	
800	850	1275	900	945	1040	6KGP631K1X1XBCA1	403664	6KGP631K1X1XXCA1	403567	61	
900	945	1417.5	1000	1060	1166	6KGP631K2X1XBCA1	403665	6KGP631K2X1XXCA1	403568	62	
1000	1060	1590	1200	1260	1386	6KGP631K3X1XBCA1	403666	6KGP631K3X1XXCA1	403569	62	
1200	1260	1890	1400	1415	1557	6KGP631K6X1XBCA1	404738	6KGP631K6X1XXCA1	404739	62	

(1) IP21 kits are available as field installed options for all 230V drives from 0.25 to 37kW for all 400V drives from 0.37 to 75kW. See Page 21.



## IP00 / IP20 / IP21, with EMC filter Class A1/B1 (C1/C2) 230V, 3-phase, 50/60Hz input

Heavy Duty rating Nominal motor ratings			Light Duty rating Nominal motor ratings			Enclosure type <sup>(1)</sup> :	WITH braking chopper		WITHOUT braking chopper		Unit size
Power kW	Current A	Overload current during 60s (A)	Power kW	Current A	Overload current during 60s (A)		Cat. No.	Ref. No.	Cat. No.	Ref. No.	
0.25	1.8	2.88	0.25	1.8	2.88	IP20	6KGP23F33X9RBXA1		6KGP23F33X9RXXA1		12
0.37	2.4	3.84	0.37	2.4	3.84		6KGP23F50X9RBXA1		6KGP23F50X9RXXA1		12
0.75	4.6	7.36	0.75	4.6	7.36		6KGP23001X9RBXA1		6KGP23001X9RXXA1		12
1.5	7.5	12	1.5	7.5	12		6KGP23002X9RBXA1		6KGP23002X9RXXA1		12
2.2	10.6	16.96	2.2	10.6	16.96		6KGP23003X9RBXA1		6KGP23003X9RXXA1		12
3.7	16.7	26.72	3.7	16.7	26.72		6KGP23005X9RBXA1		6KGP23005X9RXXA1		13
5.5	24.2	38.72	5.5/7.5	30.8	33.88		6KGP23007X9RBXA1		6KGP23007X9RXXA1		23
7.5	30.8	49.28	11	46.2	50.82		6KGP23010X9RBXA1	on request	6KGP23010X9RXXA1	on request	23
11	46.2	73.92	15	59.4	65.34		6KGP23015X9RBXA1		6KGP23015X9RXXA1		24
15	59.4	89.1	18.5	74.8	82.28		6KGP23020X9RBXA1		6KGP23020X9RXXA1		24
18.5	74.8	112.2	22	88	96.8		6KGP23025X9RBXA1		6KGP23025X9RXXA1		33
22	88	132	30	115	126.5		6KGP23030X9RBXA1		6KGP23030X9RXXA1		33
30	115	172.5	37	143	157.3		6KGP23040X9RBXA1		6KGP23040X9RXXA1		34
37	143	214.5	45	170	187		6KGP23050X9RBXA1		6KGP23050X9RXXA1		34

## 400V, 3-phase, 50/60Hz input

Heavy Duty rating Nominal motor ratings			Light Duty rating Nominal motor ratings			Enclosure type <sup>(1)</sup> :	WITH braking chopper		WITHOUT braking chopper		Unit size
Power kW	Current A	Overload current during 60s (A)	Power kW	Current A	Overload current during 60s (A)		Cat. No.	Ref. No.	Cat. No.	Ref. No.	
0.37	1.3	2.08	0.37	1.3	1.43	IP20	6KGP43F50X9RBXA1	403203	6KGP43F50X9RXXA1	402935	12
0.75	2.4	3.84	0.75	2.4	2.64		6KGP43001X9RBXA1	403204	6KGP43001X9RXXA1	402936	12
1.5	4.1	6.56	1.5	4.1	4.51		6KGP43002X9RBXA1	403205	6KGP43002X9RXXA1	402937	12
2.2	5.6	8.96	2.2	5.6	6.16		6KGP43003X9RBXA1	403206	6KGP43003X9RXXA1	402938	12
4	10	16	4	10	11		6KGP43005X9RBXA1	403207	6KGP43005X9RXXA1	402939	12
5.5	13	20.8	5.5	13	14.3		6KGP43007X9RBXA1	403208	6KGP43007X9RXXA1	402940	13
7.5	16	25.6	7.5	16	17.6		6KGP43010X9RBXA1	403209	6KGP43010X9RXXA1	402941	13
11	24	38.4	11/15	32	35.2		6KGP43015X9RBXA1	403210	6KGP43015X9RXXA1	402942	23
15	32	51.2	18.5	37.5	41.25		6KGP43020X9RBXA1	403211	6KGP43020X9RXXA1	402943	23
18.5	37.5	60	22	44	48.4		6KGP43025X9RBXA1	403212	6KGP43025X9RXXA1	402944	24
22	44	70.4	30	61	67.1		6KGP43030X9RBXA1	403213	6KGP43030X9RXXA1	402945	24
30	61	97.6	37	73	80.3		6KGP43040X9RBXA1	403214	6KGP43040X9RXXA1	402946	24
37	73	116.8	45	90	99		6KGP43050X9RBXA1	403215	6KGP43050X9RXXA1	402947	33
45	90	144	55	106	116.6		6KGP43060X9RBXA1	403216	6KGP43060X9RXXA1	402948	33
55	105	168	75	147	161.7		6KGP43075X9RBXA1	403217	6KGP43075X9RXXA1	402949	34
75	147	235.2	90	177	194.7		6KGP43100X9RBXA1	403218	6KGP43100X9RXXA1	402950	34
90	177	265.5	110	212	233.2		6KGP43125X9RBCB1	409634	6KGP43125X9RXXC1	409607	43h
110	212	318	132	260	286		6KGP43150X9RBCB1	409635	6KGP43150X9RXXC1	409608	43h
132	260	390	160	315	346.5		6KGP43200X9RBCB1	409636	6KGP43200X9RXXC1	409609	43h
160	315	472.5	200	395	434.5	6KGP43250X9RBCB1	409637	6KGP43250X9RXXC1	409610	44h	
200	395	592.5	250	480	528	6KGP43300X9RBCB1	409638	6KGP43300X9RXXC1	409611	44h	
250	480	720	315	588	647	6KGP43350X9RBCB1	409639	6KGP43350X9RXXC1	409612	44h	
315	600	900	355	658	723.8	6KGP43400X9RBCA1	403225	6KGP43400X9RXXC1	402957	52	
355	658	987	400	745	819.5	6KGP43500X9RBCA1	403226	6KGP43500X9RXXC1	402958	52	
400	745	1117.5	450	800	880	6KGP43550X9RBCA1	403227	6KGP43550X9RXXC1	402959	52	
450	800	1200	500	880	968	6KGP43600X1RBCA1	403228	6KGP43600X1RXXC1	402960	63	
500	880	1320	560	990	1089	6KGP43650X1RBCA1	403229	6KGP43650X1RXXC1	402961	63	
560	990	1485	630	1120	1232	6KGP43750X1RBCA1	403230	6KGP43750X1RXXC1	402962	63	
630	1120	1680	710	1260	1386	6KGP43900X1RBCA1	403231	6KGP43900X1RXXC1	402963	63	
710	1260	1890	800	1460	1606	6KGP431K0X1RBCA1	403232	6KGP431K0X1RXXC1	402964	64	
800	1460	2190	1000	1700	1870	6KGP431K2X1RBCA1	403233	6KGP431K2X1RXXC1	402965	64	

## 690V, 3-phase, 50/60Hz input

Heavy Duty rating Nominal motor ratings			Light Duty rating Nominal motor ratings			Enclosure type:	WITH braking chopper		WITHOUT braking chopper		Unit size
Power kW	Current A	Overload current during 60s (A)	Power kW	Current A	Overload current during 60s (A)		Cat. No.	Ref. No.	Cat. No.	Ref. No.	
11	13	20.8	15	18	20	IP21 conformal coated	6KGP63015X1RBCA1	403822	6KGP63015X1RXXC1	403768	22
15	18	28.8	18.5	22	24		6KGP63020X1RBCA1	403823	6KGP63020X1RXXC1	403769	22
18.5	22	35.2	22	27	30		6KGP63025X1RBCA1	403824	6KGP63025X1RXXC1	403770	22
22	27	43.2	30	34	37		6KGP63030X1RBCA1	403825	6KGP63030X1RXXC1	403771	22
30	34	51	37	41	45		6KGP63040X1RBCA1	403826	6KGP63040X1RXXC1	403772	32
37	41	61.5	45	52	56		6KGP63050X1RBCA1	403827	6KGP63050X1RXXC1	403773	32
45	52	76.5	55	62	68		6KGP63060X1RBCA1	403828	6KGP63060X1RXXC1	403774	32
55	62	93	75	83	91		6KGP63075X1RBCA1	403829	6KGP63075X1RXXC1	403775	32
75	83	124.5	90	100	110		6KGP63100X1RBCA1	403830	6KGP63100X1RXXC1	403776	32
90	108	162	110	131	144		6KGP63125X9RBCB1		6KGP63125X8RXXC1		
110	131	196.5	132	155	171		6KGP63150X9RBCB1		6KGP63150X8RXXC1		
132	155	232.5	160	192	211		6KGP63200X9RBCB1		6KGP63200X8RXXC1		
160	192	288	200	242	266		6KGP63250X9RBCB1		6KGP63250X8RXXC1		
200	242	363	250	290	319		6KGP63300X9RBCB1		6KGP63300X8RXXC1		
250	290	435	315	344	378		6KGP63350X9RBCB1		6KGP63350X8RXXC1		
315	344	516	400	400	440		6KGP63450X9RBCB1		6KGP63450X8RXXC1		
355	380	570	450	450	495		6KGP63500X8RBCA1	on request	6KGP63500X8RXXC1	on request	
400	410	615	500	500	550		6KGP63650X8RBCA1		6KGP63650X8RXXC1		
500	500	750	560	570	627		6KGP63750X8RBCA1		6KGP63750X8RXXC1		
560	570	855	630	630	693	6KGP63900X1RBCA1		6KGP63900X1RXXC1			
630	630	945	710	730	803	6KGP631K0X1RBCA1		6KGP631K0X1RXXC1			
710	730	1095	800	850	935	6KGP631K1X1RBCA1		6KGP631K1X1RXXC1			
800	850	1275	900	945	1040	6KGP631K2X1RBCA1		6KGP631K2X1RXXC1			
900	945	1417.5	1000	1060	1166	6KGP631K3X1RBCA1		6KGP631K3X1RXXC1			
1000	1060	1590	1200	1260	1386	6KGP631K6X1RBCA1		6KGP631K6X1RXXC1			
1200	1260	1890	1400	1415	1557	6KGP631K9X1RBCA1		6KGP631K9X1RXXC1			

(1) IP21 kits are available as field installed options for all 230V drives from 0.25 to 37kW for all 400V drives from 0.37 to 75kW. See Page 21.



**IP54 / IP55, with EMC filter Class A2 (C3)**

**230V, 3-phase, 50/60Hz input**

Heavy duty rating Nominal motor ratings			Light duty rating Nominal motor ratings			Enclosure type:	WITH braking chopper		WITHOUT braking chopper		Unit size
Power kW	Current A	Overload current during 60s (A)	Power kW	Current A	Overload current during 60s (A)		Cat. No.	Ref. No.	Cat. No.	Ref. No.	
0.25	1.8	2.88	0.25	1.8	2.88	IP55	6KGP23F33X2XBXA1		6KGP23F33X2XXXA1	404710	15
0.37	2.4	3.84	0.37	2.4	3.84		6KGP23F50X2XBXA1		6KGP23F50X2XXXA1	404711	15
0.75	4.6	7.36	0.75	4.6	7.36		6KGP23001X2XBXA1		6KGP23001X2XXXA1	404712	15
1.5	7.5	12	1.5	7.5	12		6KGP23002X2XBXA1		6KGP23002X2XXXA1	404713	15
2.2	10.6	16.96	2.2	10.6	16.96		6KGP23003X2XBXA1		6KGP23003X2XXXA1	404714	15
3.7	16.7	26.72	3.7	16.7	26.72		6KGP23005X2XBXA1		6KGP23005X2XXXA1	404715	15
5.5	24.2	38.72	5.5/7.5	30.8	33.88		6KGP23007X2XBXA1		6KGP23007X2XXXA1	404716	21
7.5	30.8	49.28	11	46.2	50.82		6KGP23010X2XBXA1	on request	6KGP23010X2XXXA1	404717	21
11	46.2	73.92	15	59.4	65.34		6KGP23015X2XBXA1		6KGP23015X2XXXA1	404718	22
15	59.4	89.1	18.5	74.8	82.28		6KGP23020X2XBXA1		6KGP23020X2XXXA1	404719	31
18.5	74.8	112.2	22	88	96.8		6KGP23025X2XBXA1		6KGP23025X2XXXA1	404720	31
22	88	132	30	115	126.5		6KGP23030X2XBXA1		6KGP23030X2XXXA1	404721	31
30	115	172.5	37	143	157.3		6KGP23040X2XBXA1		6KGP23040X2XXXA1	404722	32
37	143	214.5	45	170	187		6KGP23050X2XBXA1		6KGP23050X2XXXA1	404723	32

**400V, 3-phase, 50/60Hz input**

Heavy Duty rating Nominal motor ratings			Light Duty rating Nominal motor ratings			Enclosure type:	WITH braking chopper		WITHOUT braking chopper		Unit size
Power kW	Current A	Overload current during 60s (A)	Power kW	Current A	Overload current during 60s (A)		Cat. No.	Ref. No.	Cat. No.	Ref. No.	
0.37	1.3	2.08	0.37	1.3	1.43	IP55	6KGP43F50X2XBXA1	403156	6KGP43F50X2XXXA1	402888	15
0.75	2.4	3.84	0.75	2.4	2.64		6KGP43001X2XBXA1	403157	6KGP43001X2XXXA1	402889	15
1.5	4.1	6.56	1.5	4.1	4.51		6KGP43002X2XBXA1	403158	6KGP43002X2XXXA1	402890	15
2.2	5.6	8.96	2.2	5.6	6.16		6KGP43003X2XBXA1	403159	6KGP43003X2XXXA1	402891	15
4	10	16	4	10	11		6KGP43005X2XBXA1	403160	6KGP43005X2XXXA1	402892	15
5.5	13	20.8	5.5	13	14.3		6KGP43007X2XBXA1	403161	6KGP43007X2XXXA1	402893	15
7.5	16	25.6	7.5	16	17.6		6KGP43010X2XBXA1	403162	6KGP43010X2XXXA1	402894	15
11	24	38.4	11/15	32	35.2		6KGP43015X2XBXA1	403163	6KGP43015X2XXXA1	402895	21
15	32	51.2	18.5	37.5	41.25		6KGP43020X2XBXA1	403164	6KGP43020X2XXXA1	402896	21
18.5	37.5	60	22	44	48.4		6KGP43025X2XBXA1	403165	6KGP43025X2XXXA1	402897	22
22	44	70.4	30	61	67.1		6KGP43030X2XBXA1	403166	6KGP43030X2XXXA1	402898	22
30	61	97.6	37	73	80.3		6KGP43040X2XBXA1	403167	6KGP43040X2XXXA1	402899	22
37	73	116.8	45	90	99		6KGP43050X2XBXA1	403168	6KGP43050X2XXXA1	402900	31
45	90	144	55	106	116.6		6KGP43060X2XBXA1	403169	6KGP43060X2XXXA1	402901	31
55	105	168	75	147	161.7		6KGP43075X2XBXA1	403170	6KGP43075X2XXXA1	402902	32
75	147	235.2	90	177	194.7		6KGP43100X2XBXA1	403171	6KGP43100X2XXXA1	402903	32
90	177	265.5	110	212	233.2	6KGP43125X2XBCB1	409626	6KGP43125X2XXCB1	409646	41h	
110	212	318	132	260	286	6KGP43150X2XBCB1	409628	6KGP43150X2XXCB1	409647	41h	
132	260	390	160	315	346.5	6KGP43200X2XBCB1	409630	6KGP43200X2XXCB1	409648	41h	
160	315	472.5	200	395	434.5	6KGP43250X2XBCB1	409631	6KGP43250X2XXCB1	409649	42h	
200	395	592.5	250	480	528	6KGP43300X2XBCB1	409632	6KGP43300X2XXCB1	409650	42h	
250	480	720	315	600	660	6KGP43350X2XBCB1	409633	6KGP43350X2XXCB1	409660	42h	
315	600	900	355	658	723.8	6KGP43400X2XBCA1	403178	6KGP43400X2XXCA1	402910	52	
355	658	987	400	745	819.5	6KGP43500X2XBCA1	403179	6KGP43500X2XXCA1	402911	52	
400	745	1117.5	450	800	880	6KGP43550X2XBCA1	403180	6KGP43550X2XXCA1	402912	52	
450	800	1200	500	880	968	6KGP43600X2XBCA1	403181	6KGP43600X2XXCA1	402913	61	
500	880	1320	560	990	1089	6KGP43650X2XBCA1	403182	6KGP43650X2XXCA1	402914	61	
560	990	1485	630	1120	1239	6KGP43750X2XBCA1	403183	6KGP43750X2XXCA1	402915	61	
630	1120	1680	710	1260	1386	6KGP43900X2XBCA1	403184	6KGP43900X2XXCA1	402916	61	
710	1260	1890	800	1460	1606	6KGP431K0X2XBCA1	403185	6KGP431K0X2XXCA1	402917	62	
800	1460	2190	1000	1700	1870	6KGP431K2X2XBCA1	403186	6KGP431K2X2XXCA1	402918	62	

**690V, 3-phase, 50/60Hz input**

Heavy Duty rating Nominal motor ratings			Light Duty rating Nominal motor ratings			Enclosure type:	WITH braking chopper		WITHOUT braking chopper		Unit size
Power kW	Current A	Overload current during 60s (A)	Power kW	Current A	Overload current during 60s (A)		Cat. No.	Ref. No.	Cat. No.	Ref. No.	
11	13	20.8	15	18	20	IP55 conformal coated	6KGP63015X2XBCA1	403804	6KGP63015X2XXCA1	403750	22
15	18	28.8	18.5	22	24		6KGP63020X2XBCA1	403805	6KGP63020X2XXCA1	403751	22
18.5	22	35.2	22	27	30		6KGP63025X2XBCA1	403806	6KGP63025X2XXCA1	403752	22
22	27	43.2	30	34	37		6KGP63030X2XBCA1	403807	6KGP63030X2XXCA1	403753	22
30	34	51	37	41	45		6KGP63040X2XBCA1	403808	6KGP63040X2XXCA1	403754	32
37	41	61.5	45	52	56		6KGP63050X2XBCA1	403809	6KGP63050X2XXCA1	403755	32
45	52	76.5	55	62	68		6KGP63060X2XBCA1	403810	6KGP63060X2XXCA1	403756	32
55	62	93	75	83	91		6KGP63075X2XBCA1	403811	6KGP63075X2XXCA1	403757	32
75	83	124.5	90	100	110		6KGP63100X2XBCA1	403812	6KGP63100X2XXCA1	403758	32
90	108	162	110	131	144		6KGP63125X2XBCB1	409672	6KGP63125X2XXCB1	409658	45h
110	131	196.5	132	155	171		6KGP63150X2XBCB1	409673	6KGP63150X2XXCB1	409659	45h
132	155	232.5	160	192	211		6KGP63200X2XBCB1	409674	6KGP63200X2XXCB1	409660	45h
160	192	288	200	242	266		6KGP63250X2XBCB1	409675	6KGP63250X2XXCB1	409661	47h
200	242	363	250	290	319		6KGP63300X2XBCB1	409676	6KGP63300X2XXCB1	409662	47h
250	290	435	315	344	378		6KGP63350X2XBCB1	409677	6KGP63350X2XXCB1	409663	47h
315	344	516	400	400	440		6KGP63450X2XBCB1	409678	6KGP63450X2XXCB1	409664	47h
355	380	570	450	450	495	6KGP63500X2XBCA1	403696	6KGP63500X2XXCA1	403597	52	
400	410	615	500	500	550	6KGP63550X2XBCA1	403697	6KGP63550X2XXCA1	403598	52	
500	500	750	560	570	627	6KGP63650X2XBCA1	403698	6KGP63650X2XXCA1	403599	52	
560	570	855	630	630	693	6KGP63750X2XBCA1	403699	6KGP63750X2XXCA1	403600	52	
630	630	945	710	730	803	6KGP63900X2XBCA1	403700	6KGP63900X2XXCA1	403601	61	
710	730	1095	800	850	935	6KGP631K0X2XBCA1	403701	6KGP631K0X2XXCA1	403602	61	
800	850	1275	900	945	1040	6KGP631K1X2XBCA1	403702	6KGP631K1X2XXCA1	403603	61	
900	945	1417.5	1000	1060	1166	6KGP631K2X2XBCA1	403703	6KGP631K2X2XXCA1	403604	62	
1000	1060	1590	1200	1260	1386	6KGP631K3X2XBCA1	403704	6KGP631K3X2XXCA1	403605	62	
1200	1260	1890	1400	1415	1557	6KGP631K6X2XBCA1	404740	6KGP631K6X1XXCA1	404741	62	



## IP54 / IP55, with EMC filter A1/B1 (C1/C2) 230V, 3-phase, 50/60Hz input

Heavy duty rating Nominal motor ratings			Light duty rating Nominal motor ratings			Enclosure type:	WITH braking chopper		WITHOUT braking chopper		Unit size
Power kW	Current A	Overload current during 60s (A)	Power kW	Current A	Overload current during 60s (A)		Cat. No.	Ref. No.	Cat. No.	Ref. No.	
0.25	1.8	2.88	0.25	1.8	2.88	IP55	6KGP23F33X2R8XA1		6KGP23F33X2RXXA1		15
0.37	2.4	3.84	0.37	2.4	3.84		6KGP23F50X2R8XA1		6KGP23F50X2RXXA1		15
0.75	4.6	7.36	0.75	4.6	7.36		6KGP23001X2R8XA1		6KGP23001X2RXXA1		15
1.5	7.5	12	1.5	7.5	12		6KGP23002X2R8XA1		6KGP23002X2RXXA1		15
2.2	10.6	16.96	2.2	10.6	16.96		6KGP23003X2R8XA1		6KGP23003X2RXXA1		15
3.7	16.7	26.72	3.7	16.7	26.72		6KGP23005X2R8XA1		6KGP23005X2RXXA1		15
5.5	24.2	38.72	5.5/7.5	30.8	33.88		6KGP23007X2R8XA1	on request	6KGP23007X2RXXA1	on request	21
7.5	30.8	49.28	11	46.2	50.82		6KGP23010X2R8XA1		6KGP23010X2RXXA1		21
11	46.2	73.92	15	59.4	65.34		6KGP23015X2R8XA1		6KGP23015X2RXXA1		22
15	59.4	89.1	18.5	74.8	82.28		6KGP23020X2R8XA1		6KGP23020X2RXXA1		31
18.5	74.8	112.2	22	88	96.8		6KGP23025X2R8XA1		6KGP23025X2RXXA1		31
22	88	132	30	115	126.5		6KGP23030X2R8XA1		6KGP23030X2RXXA1		31
30	115	172.5	37	143	157.3		6KGP23040X2R8XA1		6KGP23040X2RXXA1		32
37	143	214.5	45	170	187		6KGP23050X2R8XA1		6KGP23050X2RXXA1		32

## 400V, 3-phase, 50/60Hz input

Heavy Duty rating Nominal motor ratings			Light Duty rating Nominal motor ratings			Enclosure type:	WITH braking chopper		WITHOUT braking chopper		Unit size
Power kW	Current A	Overload current during 60s (A)	Power kW	Current A	Overload current during 60s (A)		Cat. No.	Ref. No.	Cat. No.	Ref. No.	
0.37	1.3	2.08	0.37	1.3	1.43	IP55	6KGP43F50X2R8XA1	403243	6KGP43F50X2RXXA1	402975	15
0.75	2.4	3.84	0.75	2.4	2.64		6KGP43001X2R8XA1	403244	6KGP43001X2RXXA1	402976	15
1.5	4.1	6.56	1.5	4.1	4.51		6KGP43002X2R8XA1	403245	6KGP43002X2RXXA1	402977	15
2.2	5.6	8.96	2.2	5.6	6.16		6KGP43003X2R8XA1	403246	6KGP43003X2RXXA1	402978	15
4	10	16	4	10	11		6KGP43005X2R8XA1	403247	6KGP43005X2RXXA1	402979	15
5.5	13	20.8	5.5	13	14.3		6KGP43007X2R8XA1	403248	6KGP43007X2RXXA1	402980	15
7.5	16	25.6	7.5	16	17.6		6KGP43010X2R8XA1	403249	6KGP43010X2RXXA1	402981	15
11	24	38.4	11/15	32	35.2		6KGP43015X2R8XA1	403250	6KGP43015X2RXXA1	402982	21
15	32	51.2	18.5	37.5	41.25		6KGP43020X2R8XA1	403251	6KGP43020X2RXXA1	402983	21
18.5	37.5	60	22	44	48.4		6KGP43025X2R8XA1	403252	6KGP43025X2RXXA1	402984	22
22	44	70.4	30	61	67.1		6KGP43030X2R8XA1	403253	6KGP43030X2RXXA1	402985	22
30	61	97.6	37	73	80.3		6KGP43040X2R8XA1	403254	6KGP43040X2RXXA1	402986	31
37	73	116.8	45	90	99		6KGP43050X2R8XA1	403255	6KGP43050X2RXXA1	402987	31
45	90	144	55	106	116.6		6KGP43060X2R8XA1	403256	6KGP43060X2RXXA1	402988	31
55	105	168	75	147	161.7		6KGP43075X2R8XA1	403257	6KGP43075X2RXXA1	402989	32
75	147	235.2	90	177	194.7		6KGP43100X2R8XA1	403258	6KGP43100X2RXXA1	402990	32
90	177	265.5	110	212	233.2		6KGP43125X2R8XA1	409640	6KGP43125X2RXXA1	409613	45h
110	212	318	132	260	286		6KGP43150X2R8XA1	409641	6KGP43150X2RXXA1	409614	45h
132	260	390	160	315	346.5	6KGP43200X2R8XA1	409642	6KGP43200X2RXXA1	409615	45h	
160	315	472.5	200	395	434.5	6KGP43250X2R8XA1	409643	6KGP43250X2RXXA1	409616	47h	
200	395	592.5	250	480	528	6KGP43300X2R8XA1	409644	6KGP43300X2RXXA1	409617	47h	
250	480	720	315	588	647	6KGP43350X2R8XA1	409645	6KGP43350X2RXXA1	409618	47h	
315	600	900	355	658	723.8	6KGP43400X2R8XA1	403265	6KGP43400X2RXXA1	402997	52	
355	658	987	400	745	819.5	6KGP43500X2R8XA1	403266	6KGP43500X2RXXA1	402998	52	
400	745	1117.5	450	800	880	6KGP43550X2R8XA1	403267	6KGP43550X2RXXA1	402999	52	
450	800	1200	500	880	968	6KGP43600X2R8XA1	403268	6KGP43600X2RXXA1	403094	63	
500	880	1320	560	990	1089	6KGP43650X2R8XA1	403269	6KGP43650X2RXXA1	403095	63	
560	990	1485	630	1120	1232	6KGP43750X2R8XA1	403270	6KGP43750X2RXXA1	403096	63	
630	1120	1680	710	1260	1386	6KGP43900X2R8XA1	403271	6KGP43900X2RXXA1	403097	63	
710	1260	1890	800	1460	1606	6KGP431K0X2R8XA1	403272	6KGP431K0X2RXXA1	403098	64	
800	1460	2190	1000	1700	1870	6KGP431K2X2R8XA1	403273	6KGP431K2X2RXXA1	403099	64	

## 690V, 3-phase, 50/60Hz input

Heavy Duty rating Nominal motor ratings			Light Duty rating Nominal motor ratings			Enclosure type:	WITH braking chopper		WITHOUT braking chopper		Unit size
Power kW	Current A	Overload current during 60s (A)	Power kW	Current A	Overload current during 60s (A)		Cat. No.	Ref. No.	Cat. No.	Ref. No.	
11	13	20.8	15	18	20	IP55 conformal coated	6KGP63015X2R8XA1	403831	6KGP63015X2RXXA1	403777	22
15	18	28.8	18.5	22	24		6KGP63020X2R8XA1	403832	6KGP63020X2RXXA1	403778	22
18.5	22	35.2	22	27	30		6KGP63025X2R8XA1	403833	6KGP63025X2RXXA1	403779	22
22	27	43.2	30	34	37		6KGP63030X2R8XA1	403834	6KGP63030X2RXXA1	403780	22
30	34	51	37	41	45		6KGP63040X2R8XA1	403835	6KGP63040X2RXXA1	403781	32
37	41	61.5	45	52	56		6KGP63050X2R8XA1	403836	6KGP63050X2RXXA1	403782	32
45	52	76.5	55	62	68		6KGP63060X2R8XA1	403837	6KGP63060X2RXXA1	403783	32
55	62	93	75	83	91		6KGP63075X2R8XA1	403838	6KGP63075X2RXXA1	403784	32
75	83	124.5	90	100	110		6KGP63100X2R8XA1	403839	6KGP63100X2RXXA1	403785	32
90	108	162	110	131	144		6KGP63125X2R8XA1		6KGP63125X2RXXA1		
110	131	196.5	132	155	171		6KGP63150X2R8XA1		6KGP63150X2RXXA1		
132	155	232.5	160	192	211		6KGP63200X2R8XA1		6KGP63200X2RXXA1		
160	192	288	200	242	266		6KGP63250X2R8XA1		6KGP63250X2RXXA1		
200	242	363	250	290	319		6KGP63300X2R8XA1		6KGP63300X2RXXA1		
250	290	435	315	344	378		6KGP63350X2R8XA1		6KGP63350X2RXXA1		
315	344	516	400	400	440		6KGP63400X2R8XA1		6KGP63400X2RXXA1		
355	380	570	450	450	495		6KGP63500X2R8XA1	on request	6KGP63500X2RXXA1	on request	
400	410	615	500	500	550		6KGP63650X2R8XA1		6KGP63650X2RXXA1		
500	500	750	560	570	627	6KGP63750X2R8XA1	6KGP63750X2RXXA1				
560	570	855	630	630	693	6KGP63900X2R8XA1	6KGP63900X2RXXA1				
630	630	945	710	730	803	6KGP631K0X2R8XA1	6KGP631K0X2RXXA1				
710	730	1095	800	850	935	6KGP631K1X2R8XA1	6KGP631K1X2RXXA1				
800	850	1275	900	945	1040	6KGP631K2X2R8XA1	6KGP631K2X2RXXA1				
900	945	1417.5	1000	1060	1166	6KGP631K3X2R8XA1	6KGP631K3X2RXXA1				
1000	1060	1590	1200	1260	1386	6KGP631K6X2R8XA1	6KGP631K6X2RXXA1				
1200	1260	1890	1400	1415	1557	6KGP631K9X2R8XA1	6KGP631K9X2RXXA1				



**IP66, with EMC filter Class A2 (C3)**

**230V, 3-phase, 50/60Hz input**

Heavy Duty rating Nominal motor ratings			Light Duty rating Nominal motor ratings			WITH braking chopper		WITHOUT braking chopper		Unit size
Power kW	Current A	Overload current during 60s (A)	Power kW	Current A	Overload current during 60s (A)	Cat. No.	Ref. No.	Cat. No.	Ref. No.	
0.25	1.8	2.88	0.25	1.8	2.88	6KGP23F33X4XBXA1		6KGP23F33X4XXXA1	404724	15
0.37	2.4	3.84	0.37	2.4	3.84	6KGP23F50X4XBXA1		6KGP23F50X4XXXA1	404725	15
0.75	4.6	7.36	0.75	4.6	7.36	6KGP23001X4XBXA1		6KGP23001X4XXXA1	404726	15
1.5	7.5	12	1.5	7.5	12	6KGP23002X4XBXA1		6KGP23002X4XXXA1	404727	15
2.2	10.6	16.96	2.2	10.6	16.96	6KGP23003X4XBXA1		6KGP23003X4XXXA1	404728	15
3.7	16.7	26.72	3.7	16.7	26.72	6KGP23005X4XBXA1		6KGP23005X4XXXA1	404729	15
5.5	24.2	38.72	5.5/7.5	30.8	33.88	6KGP23007X4XBXA1	on request	6KGP23007X4XXXA1	404730	21
7.5	30.8	49.28	11	46.2	50.82	6KGP23010X4XBXA1		6KGP23010X4XXXA1	404731	21
11	46.2	73.92	15	59.4	65.34	6KGP23015X4XBXA1		6KGP23015X4XXXA1	404732	22
15	59.4	89.1	18.5	74.8	82.28	6KGP23020X4XBXA1		6KGP23020X4XXXA1	404733	31
18.5	74.8	112.2	22	88	96.8	6KGP23025X4XBXA1		6KGP23025X4XXXA1	404734	31
22	88	132	30	115	126.5	6KGP23030X4XBXA1		6KGP23030X4XXXA1	404735	31
30	115	172.5	37	143	157.3	6KGP23040X4XBXA1		6KGP23040X4XXXA1	404736	32
37	143	214.5	45	170	187	6KGP23050X4XBXA1		6KGP23050X4XXXA1	404737	32

**400V, 3-phase, 50/60Hz input**

Heavy Duty rating Nominal motor ratings			Light Duty rating Nominal motor ratings			WITH braking chopper		WITHOUT braking chopper		Unit size
Power kW	Current A	Overload current during 60s (A)	Power kW	Current A	Overload current during 60s (A)	Cat. No.	Ref. No.	Cat. No.	Ref. No.	
0.37	1.3	2.08	0.37	1.3	1.43	6KGP43F50X4XBXA1	403187	6KGP43F50X4XXXA1	402919	15
0.75	2.4	3.84	0.75	2.4	2.64	6KGP43001X4XBXA1	403188	6KGP43001X4XXXA1	402920	15
1.5	4.1	6.56	1.5	4.1	4.51	6KGP43002X4XBXA1	403189	6KGP43002X4XXXA1	402921	15
2.2	5.6	8.96	2.2	5.6	6.16	6KGP43003X4XBXA1	403190	6KGP43003X4XXXA1	402922	15
4	10	16	4	10	11	6KGP43005X4XBXA1	403191	6KGP43005X4XXXA1	402923	15
5.5	13	20.8	5.5	13	14.3	6KGP43007X4XBXA1	403192	6KGP43007X4XXXA1	402924	15
7.5	16	25.6	7.5	16	17.6	6KGP43010X4XBXA1	403193	6KGP43010X4XXXA1	402925	15
11	24	38.4	11/15	32	35.2	6KGP43015X4XBXA1	403194	6KGP43015X4XXXA1	402926	21
15	32	51.2	18.5	37.5	41.25	6KGP43020X4XBXA1	403195	6KGP43020X4XXXA1	402927	21
18.5	37.5	60	22	44	48.4	6KGP43025X4XBXA1	403196	6KGP43025X4XXXA1	402928	22
22	44	70.4	30	61	67.1	6KGP43030X4XBXA1	403197	6KGP43030X4XXXA1	402929	22
30	61	97.6	37	73	80.3	6KGP43040X4XBXA1	403198	6KGP43040X4XXXA1	402930	31
37	73	116.8	45	90	99	6KGP43050X4XBXA1	403199	6KGP43050X4XXXA1	402931	31
45	90	144	55	106	116.6	6KGP43060X4XBXA1	403200	6KGP43060X4XXXA1	402932	31
55	106	169.6	75	147	161.7	6KGP43075X4XBXA1	403201	6KGP43075X4XXXA1	402933	32
75	147	235.2	90	177	194.7	6KGP43100X4XBXA1	403202	6KGP43100X4XXXA1	402934	32



## IP66, with EMC filter Class A1/B1 (C1/C2) 230V, 3-phase, 50/60Hz input

Heavy Duty rating Nominal motor ratings			Light Duty rating Nominal motor ratings			WITH braking chopper		WITHOUT braking chopper		Unit size
Power kW	Current A	Overload current during 60s (A)	Power kW	Current A	Overload current during 60s (A)	Cat. No.	Ref. No.	Cat. No.	Ref. No.	
0.25	1.8	2.88	0.25	1.8	2.88	6KGP23F33X4RBXA1		6KGP23F33X4RXXA1		15
0.37	2.4	3.84	0.37	2.4	3.84	6KGP23F50X4RBXA1		6KGP23F50X4RXXA1		15
0.75	4.6	7.36	0.75	4.6	7.36	6KGP23001X4RBXA1		6KGP23001X4RXXA1		15
1.5	7.5	12	1.5	7.5	12	6KGP23002X4RBXA1		6KGP23002X4RXXA1		15
2.2	10.6	16.96	2.2	10.6	16.96	6KGP23003X4RBXA1		6KGP23003X4RXXA1		15
3.7	16.7	26.72	3.7	16.7	26.72	6KGP23005X4RBXA1		6KGP23005X4RXXA1		15
5.5	24.2	38.72	5.5/7.5	30.8	33.88	6KGP23007X4RBXA1	on request	6KGP23007X4RXXA1	on request	21
7.5	30.8	49.28	11	46.2	50.82	6KGP23010X4RBXA1		6KGP23010X4RXXA1		21
11	46.2	73.92	15	59.4	65.34	6KGP23015X4RBXA1		6KGP23015X4RXXA1		22
15	59.4	89.1	18.5	74.8	82.28	6KGP23020X4RBXA1		6KGP23020X4RXXA1		31
18.5	74.8	112.2	22	88	96.8	6KGP23025X4RBXA1		6KGP23025X4RXXA1		31
22	88	132	30	115	126.5	6KGP23030X4RBXA1		6KGP23030X4RXXA1		31
30	115	172.5	37	143	157.3	6KGP23040X4RBXA1		6KGP23040X4RXXA1		32
37	143	214.5	45	170	187	6KGP23050X4RBXA1		6KGP23050X4RXXA1		32

## 400V, 3-phase, 50/60Hz input

Heavy Duty rating Nominal motor ratings			Light Duty rating Nominal motor ratings			WITH braking chopper		WITHOUT braking chopper		Unit size
Power kW	Current A	Overload current during 60s (A)	Power kW	Current A	Overload current during 60s (A)	Cat. No.	Ref. No.	Cat. No.	Ref. No.	
0.37	1.3	2.08	0.37	1.3	1.43	6KGP43F50X4RBXA1	403274	6KGP43F50X4RXXA1	403100	15
0.75	2.4	3.84	0.75	2.4	2.64	6KGP43001X4RBXA1	403275	6KGP43001X4RXXA1	403101	15
1.5	4.1	6.56	1.5	4.1	4.51	6KGP43002X4RBXA1	403276	6KGP43002X4RXXA1	403102	15
2.2	5.6	8.96	2.2	5.6	6.16	6KGP43003X4RBXA1	403277	6KGP43003X4RXXA1	403103	15
4	10	16	4	10	11	6KGP43005X4RBXA1	403278	6KGP43005X4RXXA1	403104	15
5.5	13	20.8	5.5	13	14.3	6KGP43007X4RBXA1	403279	6KGP43007X4RXXA1	403105	15
7.5	16	25.6	7.5	16	17.6	6KGP43010X4RBXA1	403280	6KGP43010X4RXXA1	403106	15
11	24	38.4	11/15	32	35.2	6KGP43015X4RBXA1	403281	6KGP43015X4RXXA1	403107	21
15	32	51.2	18.5	37.5	41.25	6KGP43020X4RBXA1	403282	6KGP43020X4RXXA1	403108	21
18.5	37.5	60	22	44	48.4	6KGP43025X4RBXA1	403283	6KGP43025X4RXXA1	403109	22
22	44	70.4	30	61	67.1	6KGP43030X4RBXA1	403284	6KGP43030X4RXXA1	403110	22
30	61	97.6	37	73	80.3	6KGP43040X4RBXA1	403285	6KGP43040X4RXXA1	403111	31
37	73	116.8	45	90	99	6KGP43050X4RBXA1	403286	6KGP43050X4RXXA1	403112	31
45	90	144	55	106	116.6	6KGP43060X4RBXA1	403287	6KGP43060X4RXXA1	403113	31
55	106	169.6	75	147	161.7	6KGP43075X4RBXA1	403288	6KGP43075X4RXXA1	403114	32
75	147	235.2	90	177	194.7	6KGP43100X4RBXA1	403289	6KGP43100X4RXXA1	403115	32



Options and accessories

Field installed IP21 add-on option kits



Voltage	Rating kW	IP21 Kit Cat. No.	Ref. No.
230	0.25	NEMA1ACA2	404831
	0.37	NEMA1ACA2	404831
	0.75	NEMA1ACA2	404831
	1.5	NEMA1ACA2	404831
	2.2	NEMA1ACA2	404831
	3.7	NEMA1ACA3	404832
	5.5	NEMA1ACB3	404833
	7.5	NEMA1ACB3	404833
	11	NEMA1ACB4	404834
	15	NEMA1ACB4	404834
	18.5	NEMA1ACC3	404835
	22	NEMA1ACC3	404835
	30	NEMA1ACC4	404836
	37	NEMA1ACC4	404836
400	0.37	NEMA1ACA2	404831
	0.75	NEMA1ACA2	404831
	1.5	NEMA1ACA2	404831
	2.2	NEMA1ACA2	404831
	3.7	NEMA1ACA2	404831
	5.5	NEMA1ACA3	404832
	7.5	NEMA1ACA3	404832
	11	NEMA1ACB3	404833
	15	NEMA1ACB3	404833
	18.5	NEMA1ACB4	404834
	22	NEMA1ACB4	404834
	30	NEMA1ACB4	404834
	37	NEMA1ACC3	404835
	45	NEMA1ACC3	404835
55	NEMA1ACC4	404836	
75	NEMA1ACC4	404836	

Remote mounting kit for graphical LCD keypad



Remote mounting kit for mounting graphical LCD Keypad on enclosure door for AF-650/AF-600. kit includes gasket, mounting brackets, and cable. Keypad is rated IP65.

Description	Cat. No.	Ref. No.
Remote mounting kit with cable (3m)	RMKYPDAC	404851
Remote mounting kit without cable	OPCRMKNC	404850

Communications modules



<b>Profibus DP communications module</b> Profibus DP internal drive mounted module for use on AF-650 GP and AF-600 FP drives. Supports Profibus DP V1 communications networks.	OPCPDP	404848
<b>DeviceNet communications module</b> DeviceNet internal drive mounted module for use on AF-650 GP and AF-600 FP drives. ODVA certified device.	OPCDEV	404818
<b>Ethernet IP communications module<sup>(1)</sup></b> Ethernet IP internal drive mounted module for use on AF-650 GP and AF-600 FP drives. ODVA certified device. Features 2-port built-in switch. Also includes webserver and e-mail notification.	OPCEIP	404820
<b>Modbus TCP communications module</b> Modbus TCP internal drive mounted module for use on AF-650 GP and AF-600 FP drives.	OPCMTCP	404824
<b>ProfiNet RT communications module</b> ProfiNet RT internal drive mounted module for use on AF-650 GP and AF-600 FP drives.	OPCPRT	404825

(1) Requires I/O and network slots and cannot be used with any other network or I/O modules.



## Options and accessories (continued)

### General purpose I/O module

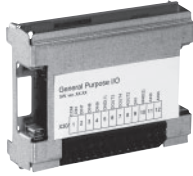

General purpose I/O internal drive mounted module for use on AF-650 GP and AF-600 FP drives.

Module includes: 3x digital inputs 24V  
2x digital outputs PNP/NPN  
2x analogue inputs 0-10V  
1x analogue output 0/4-20mA

Description	Cat. No.	Ref. No.
General purpose I/O module	OPCGPIO	404821

### Encoder module

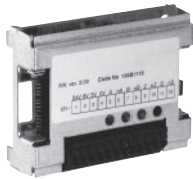

Encoder internal drive mounted module for use on the AF-650 GP drive. Module supports all 5V incremental encoders. Also supports hyperface sincos encoders.

Description	Cat. No.	Ref. No.
Encoder input module	OPCENC	404819

### Resolver module



Resolver internal drive mounted module for use on the AF-650 GP drive.

Module supports 4-8Vrms, 2.5kHz - 15kHz, 50mA resolvers. Resolution is 10bit at 4Vrms.

Description	Cat. No.	Ref. No.
Resolver input module	OPCRES	404852

### Relay output module



Relay output internal drive mounted module for use on the AF-650 GP.

Module adds (3) Form C relay outputs to the drive. Relays are rated at 2A at 240V resistive load.

Description	Cat. No.	Ref. No.
Relay output module	OPCRLY	404849

### 24V DC External supply module



24V DC external supply internal drive mounted module for use on the AF-650 GP drives. This module accepts an external 24V DC supply which is used to keep the control board of the drive and other option modules powered in the event of a Line side power outage. Can be used with Communications and I/O Modules.

Description	Cat. No.	Ref. No.
24V DC External supply module	OPC24VPS	404815

### Safe PLC I/O module



Safe PLC I/O internal drive mounted module for use on the AF-650 GP drive. This module provides a safety input based on a single pole 24V DC input.

Description	Cat. No.	Ref. No.
Safe PLC I/O Module	OPCSAFE	404853



Options and accessories (continued)

**Screw terminal accessory**

Screw terminal accessory is available for field installation on AF-650 GP drives. These screw terminals can replace the cage clamp terminals which ship with each drive. This set of three terminals are for the digital inputs, analog I/O, and RS485 connection.



Description	Cat. No.	Ref. No.
Screw terminal accessory	OPCSTERM	404822

**Pedestal kit**

Pedestal kit allows unit size 41h and 42h drives to be floor mounted (IP21 and IP55, 90 to 200/315kW at 400/690V for AF-650 GP).

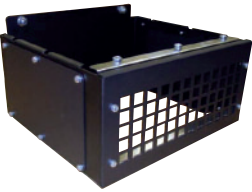

Description	Cat. No.	Ref. No.
Pedestal kit for unit size 41h	OPCPED41H	409506
Pedestal kit for unit size 42h	OPCPED42H	409507

**USB kit**

This kit allows for the USB programming terminal to be brought out to the front cover of the drive. Works with all drive types.



For all drives up to unit size 5X	OPCUSB	404861
For all unit size 6X drives	OPCUSB6X	404860

**Power shields**

These shields are used to cover the drive power terminals on IP21 and IP54/55 drive types.

For Unit size 51 drives	OPCCOVER51	404847
-------------------------	------------	--------

## Basic wiring diagrams

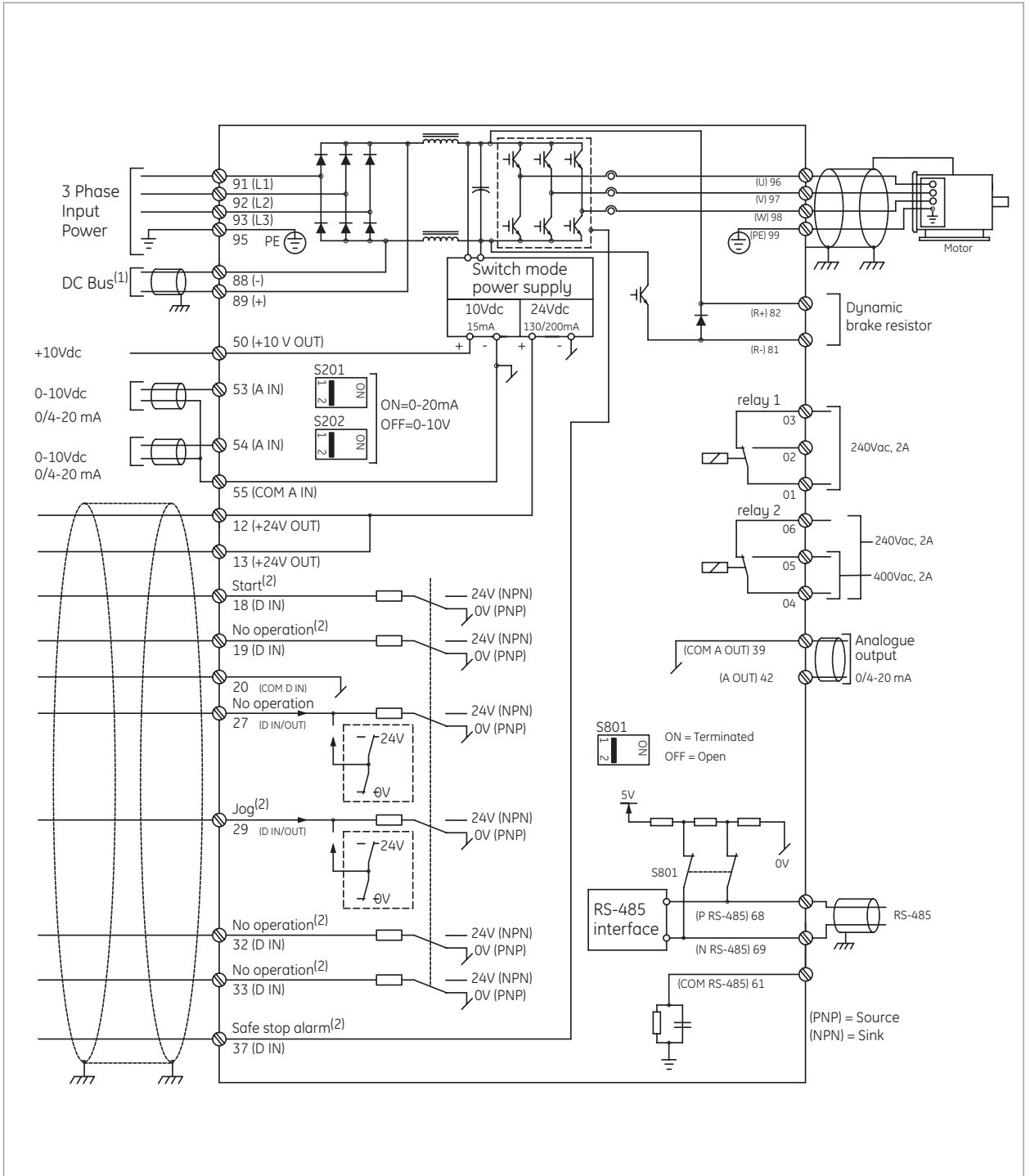

- (1) These terminals are only available with optional factory installed brake chopper.  
 (2) Indicates default setting; see parameter group E-## to re-program.



## Specifications

### Environmental conditions

Enclosures	IP20 chassis, IP00 chassis, IP21, IP55, IP54, IP66
Installation location	For use at altitudes of 1000 m or less without derating
Storage temperature	-25° to 65° C
Ambient temperature	-10° to +50° C for above 45° C, there will be derating; please consult GE
Ambient humidity	5 to 95 % RH (non-condensing)
Vibration	1.0G
Cooling method	Fan cooled all ratings. Fan control auto, 50 % level, 75 % level, 100 % level adjustable

### Standards

Approvals	CE, UL, cUL, and C-Tick Suitable for use on a circuit capable of delivering not more than 100,000 rms symmetrical amperes for 230V and 400V.
-----------	---

### Input power supply

Rated Input AC voltage	200-240 Vac, 3-phase, 50-60 Hz, +/- 10% V 380-480 Vac, 3-phase, 50-60 Hz, +/- 10% V 525-690 Vac, 3-phase, 50-60 Hz, +/- 10% V
Maximum voltage imbalance	3% of rated supply voltage
True power factor	> 0.9 at rated load
Displacement power factor	> 0.98
Switching on input power supply	Maximum twice/minute up to 7.5kW, maximum once/minute above 7.5kW
Environment according to EN60664-1	Overvoltage category III/pollution degree 2

### Output

Rated output voltage	0-100% of supply voltage
Output frequency	0-590 Hz
Switching on output	Unlimited
Accel/decel times	0.01-3600 seconds
Overload current rating	Sinusoidal PWM control (V/Hz, Avd, vector control, sensorless vector, and flux vector with motor feedback)

### Control

Starting torque	160% starting torque for 1 minute (constant torque), 110% starting torque for 1 minute (variable torque)
Carrier frequency (motor noise)	Selectable - 1, 1.5, 2, 2.5, 3, 3.5, 4, 5, 6, 7, 8, 10, 12, 14, 16 kHz
Torque boost	Selectable by up to 5 individual V/Hz settings in V/Hz Mode or by 0 - 300% setting of torque boost parameter in Adv. vector mode
Acceleration/deceleration time	0.01-3600 seconds (4 acceleration and deceleration times are selectable via digital inputs. Acceleration and deceleration patterns can be selected from linear or deceleration patterns can be selected from linear or S-curve)
Data protection	Passw protection for quick menu or main menu, 0-9999.
Pattern operation	Settings via built-in logic controller sequencer
Jump frequency control	4 jump (or skip) frequencies via parameter set to avoid mechanical vibration
Slip compensation	Maintains motor at constant speed with load fluctuations
Torque limit control	Output torque can be controlled within a range of 0.0 to 160% (0.1 and steps)
Preset speeds	8 programmable preset speeds selectable by 3 digital inputs
Trim reference setting	Available for speed reference offset via potentiometer, voltage input, or current input
DC injection braking	Starting frequency: 0.0-590 Hz, Braking time: 0.0-60.0 seconds, Braking level: 0-100% of rated current
Jogging operation	Operation via on key or digital input (Fwd or Rev)
Auto-restart after power failure	Restarts the drive without stopping after instantaneous power failure
Energy savings	Controls output voltage to minimize motor loss during constant speed operation
Start mode function	This functionality smoothly catches a spinning motor

### Logic controller (LC)

Logic controller events	Up to 37 types of programmable events
Comparators	Array of 6 comparators
Timers	Array of 8 timers, adjustable from 0.0 to 3600 sec
Logic rules	Array of 6 boolean logic rules
Logic controller states	Array of 20 logic controller action states

### Process controller (PID)

Feedback select	Up to 2 references. Selectable - no function, motor feedback, separate encoder, encoder option module, or resolver option module
Control	Normal or inverse
Anti windup	Disabled or enabled
Start speed	0.0-200 Hz
Proportional gain	0.00-10.00
Integral time	0.1 - 10000.0 ms
Differential time	0.0 - 10 s

Differential gain	1.0-50.00
Feed forward factor	0-500%
On reference bandwidth	0-200%

### Operation

Operation method	Keypad operation: hand, off, auto digital input: programmable for start/stop, forward/reverse, jog timer operation: stop after predetermined time frame Built-in RS-485 Modbus USB port for programming drive with optional PC software	
Frequency reference signal	Left or right arrow buttons on keypad in manual mode Speed potentiometer: 0 to +10 Vdc, 10 to 0 Vdc 0-10Vdc analog input 0/4-20mA analog input	
References	Up to 3 input references can be selected from analog input #1 or #2, frequency input #1 or #2, network, or potentiometer	
Input signals	6x digital inputs, 24 Vdc PNP or NPN 1x safe stop digital input suitable for category 3 installations to meet EN-954-1 2x pulse inputs rated to 110kHz or 1x pulse input and 1 - encoder Input 24 Vdc rated to 4096 PPR 2x analog inputs -10 to +10V scalable or 0/4 to 20 mA scalable	
Output signals	2x digital outputs 24 Vdc (digital outputs are used in place of 2 of the digital inputs) 2x form C relays rated to 2A at 230 Vac 1x analog output 0/4 to 20mA	
Protective functions	Line phase loss DC overvoltage DC undervoltage Drive overload Motor overtemperature Motor thermistor over-temperature Torque limit Overcurrent Ground fault Short circuit Control word timeout Brake resistor short-circuited Brake chopper short-circuited Brake check DC Link voltage high DC Link voltage low Internal fan fault External fan fault Power board overtemperature	Missing U phase Missing V phase Missing W phase Internal fault Control voltage fault Auto tune check - wrong motor parameters Auto Tune low inom - motor current is too low Current limit Mechanical brake low Drive initialized to default value Keypad error No motor Soft charge fault Auto tuning fault Serial comms bus fault Hardware mismatch Speed limit

### Keypad

Keypad features	LCD display with 6 alpha-numeric lines. multi-language support Hot pluggable, remote mount option, and copycat feature, IP65 rating when remote mounted on enclosure LED's - green - drive is on, yellow - indicates a warning, red - indicates an alarm, amber - indicates active menu keys and h-o-a keys
Password	2 level password protection
Alternate motor parameters	Up to 4 separate complete parameter set-ups are available
Graphical trending	Trend speed, power, frequency or any value programmed in status display

### RS485 modbus RTU serial communications

Physical level	EIA/RS485
Transmission distance	500m
Node address	32
Transmission speed	2400, 4800, 9600, 19200, 38400 or 115200 (bits/s)
Transmission mode	Half duplex
Transmission protocol	Modbus RTU
Character code	Binary
Character length	8 bits
Error check	CRC

### Mounting clearance

	All AF-650 GP drives can be mounted side-by-side without spacing. For all drives rated 75kW or below allow 100mm free space above and below. For all drives rated 90kW and above allow 225mm free space above and below.
--	--



## Heavy Duty efficiency, Watt loss, unit size, dimensions and weights

### 230 Vac

Nominal motor ratings		Efficiency			Watt loss (W)	Unit size	Drive type	Height (mm)	Width (mm)	Depth (mm)	Weight (kg)
Power kW	Current A	at 5 kHz (%)	at 4 kHz (%)	at 3 kHz (%)							
0.25	1.8	94			21	12	IP20 chassis	375	90	220	5
0.37	2.4	94			29	12	IP20 chassis	375	90	220	5
0.75	4.6	95			54	12	IP20 chassis	375	90	220	5
1.5	7.5	96			82	12	IP20 chassis	375	90	220	5
2.2	10.6	96			115	12	IP20 chassis	374	130	220	7
3.7	16.7	96			185	13	IP20 chassis	420	165	262	12
5.5	24.2		96.4		239	23	IP20 chassis	420	165	262	12
7.5	30.8		95.9		371	23	IP20 chassis	595	230	242	24
11	46.2		96.4		463	24	IP20 chassis	595	230	242	24
15	59.4		96		621	24	IP20 chassis	630	308	334	35
18.5	74.8			97	740	33	IP20 chassis	630	308	334	35
22	88			97	874	33	IP20 chassis	800	370	334	50
30	115			97	1143	34	IP20 chassis	800	370	334	50
37	143			97	1400	34	IP20 chassis	31.5	14.57	13.15	110.2

### 400 Vac

0.37	1.3	93			35	12	IP20 chassis	375	90	220	5
0.75	2.4	96			46	12	IP20 chassis	375	90	220	5
1.5	4.1	97			62	12	IP20 chassis	375	90	220	5
2.2	5.6	97			88	12	IP20 chassis	375	90	220	5
3.7	10	97			124	12	IP20 chassis	375	90	220	5
5.5	13	97			187	13	IP20 chassis	375	130	220	7
7.5	16	97			255	13	IP20 chassis	375	130	220	7
11	24		98		291	23	IP20 chassis	420	165	262	12
15	32		98		379	23	IP20 chassis	420	165	262	12
18.5	37.5		98		444	24	IP20 chassis	595	230	242	24
22	44		98		547	24	IP20 chassis	595	230	242	24
30	61			98	570	24	IP20 chassis	595	230	242	24
37	73			98	697	33	IP20 chassis	630	308	334	35
45	90			98	891	33	IP20 chassis	630	308	334	35
55	106			98	1022	34	IP20 chassis	800	370	334	50
75	147			99	1232	34	IP20 chassis	800	370	334	50
90	177			98	2031	43h	IP20 chassis	909	250	375	98
110	212			98	2289	43h	IP20 chassis	909	250	375	98
132	260			98	2923	43h	IP20 chassis	909	250	375	98
160	315			98	3093	44h	IP20 chassis	1122	350	375	116
200	395			98	4039	44h	IP20 chassis	1122	350	375	116
250	480				5005	44h	IP20 chassis	1122	350	375	116
315	600				6796	52	IP00 chassis	1547	585	497.8	313
355	658				7498	52	IP00 chassis	1547	585	497.8	313
400	745				7976	52	IP00 chassis	1547	585	497.8	313
450	800				9031	61	IP21	2282	1400	606	1004
500	80				10146	61	IP21	2282	1400	606	1004
560	990				10649	61	IP21	2282	1400	606	1004
630	1120				12490	61	IP21	2282	1400	606	1004
710	1260				14244	62	IP21	2282	1800	606	1262
800	1460				15466	62	IP21	2282	1800	606	1262

### 690 Vac

11	13	98			228	22	IP21	650	242	260	27
15	18	98			285	22	IP21	650	242	260	27
18.5	22	98			335	22	IP21	650	242	260	27
22	27	98			375	22	IP21	650	242	260	27
30	34	98			480	32	IP21	770	370	335	65
37	41	98			592	32	IP21	770	370	335	65
45	51	98			720	32	IP21	770	370	335	65
55	62	98			880	32	IP21	770	370	335	65
75	83	98			1800	32	IP21	770	370	335	65
90	108			98	1480	43h	IP20 chassis	909	250	375	98
110	131			98	1800	43h	IP20 chassis	909	250	375	98
132	155			98	2159	43h	IP20 chassis	909	250	375	98
160	192			98	2446	44h	IP20 chassis	1122	350	375	164
200	242			98	3123	44h	IP20 chassis	1122	350	375	164
250	290			98	3771	44h	IP20 chassis	1122	350	375	164
315	344				4258	44h	IP20 chassis	1122	350	375	164
355	380			98	4130	52	IP00 chassis	1547	585	497.8	313
400	410			98	4605	52	IP00 chassis	1547	585	497.8	313
500	500			98	6328	52	IP00 chassis	1547	585	497.8	313
560	570			98	7201	52	IP00 chassis	1547	585	497.8	313
630	630	98			7826	61	IP21	2282	1400	606	1004
710	730	98			8983	61	IP21	2282	1400	606	1004
800	850	98			10646	61	IP21	2282	1400	606	1004
900	945	98			11681	62	IP21	2282	1800	606	1262
1000	1060	98			12997	62	IP21	2282	1800	606	1262



Dimensional drawings

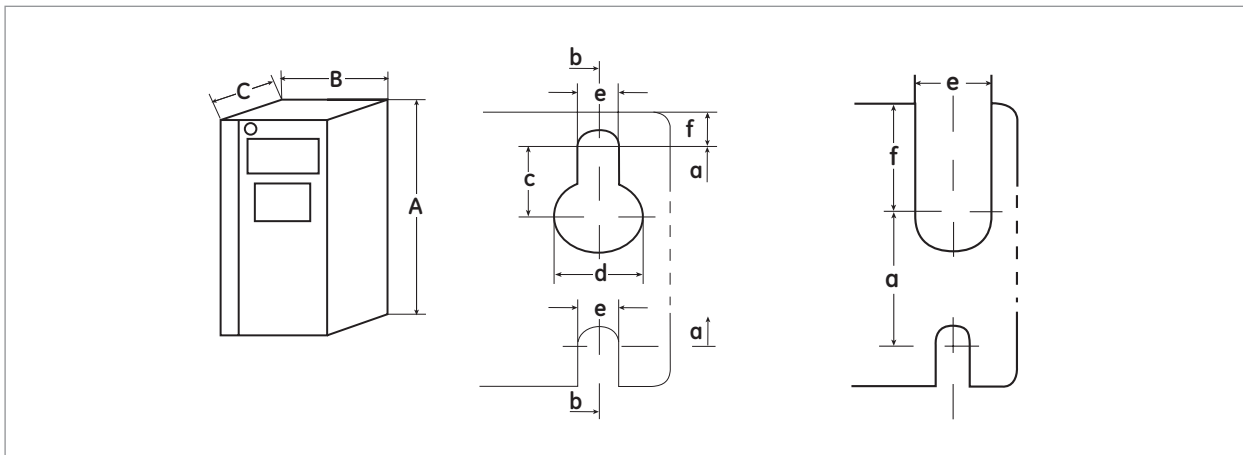

Dimensions, 1X unit sizes (mm)

Unit size		Dimensions	12	13	15 <sup>(1)</sup>
<b>Enclosure type</b>			IP20	IP20	IP55/IP66
<b>Voltage</b>	230V		0.25 to 2.2kW 1/3 to 3HP	3.7kW 5HP	0.25 to 3.7kW 1/3 to 5HP
	400V		0.37 to 3.7kW 1/2 to 5HP	5.5 to 7.5kW 7.5 to 10HP	0.37 to 7.5kW 1/2 to 10HP
<b>Height</b>	Height of backplate	A	270	270	420
	Height with de-coupling plate	A	375	375	
	Distance between mounting holes	a	257	257	402
<b>Width</b>	Width of backplate	B	90	130	240
	Distance between mounting holes	b	70	110	215
<b>Depth</b>	Depth without I/O and/or network option	C	205	205	195
	Depth with I/O and/or network option	C	220	220	195
<b>Screw holes</b>		c	8.0	8.0	8.3
		d	11.0	11.0	12.0
		e	5.5	5.5	6.5
		f	9.0	9.0	9.0
<b>Weight (kg)</b>			4.9	6.6	13.5 / 14.2

Dimensions, 2X unit sizes (mm)

Unit size		Dimensions	21 <sup>(1)</sup>	22 <sup>(1)</sup>	23	24
<b>Enclosure type</b>			IP55/IP66	IP55/IP66	IP20	IP20
<b>Voltage</b>	230V		5.5 to 7.5kW 7.5 to 10HP	11kW 15HP	5.5 to 7.5kW 7.5 to 10HP	11 to 15kW 15 to 20HP
	400V		11 to 15kW 15 to 20HP	18.5 to 22kW 25 to 30HP	11 to 15kW 15 to 20HP	18.5 to 30kW 25 to 40HP
<b>Height</b>	Height of backplate	A	480	650	400	520
	Height with de-coupling plate	A	-	-	420	595
	Distance between mounting holes	a	455	625	380	495
<b>Width</b>	Width of backplate	B	240	240	165	230
	Distance between mounting holes	b	210	210	140	200
<b>Depth</b>	Depth without I/O and/or network option	C	260	260	250	240
	Depth with I/O and/or network option	C	260	260	260	240
<b>Screw holes</b>		c	12.0	12.0	8.0	-
		d	19.0	19.0	12.0	-
		e	9.0	9.0	6.8	8.5
		f	9.0	9.0	7.9	15.0
<b>Weight (kg)</b>			23.0	27.0	12.0	23.5

(1) IP55/IP66 units need to have cable glands according table on page 28

## Dimensional drawings

### Dimensions, 3X unit sizes (mm)

Unit size		Dimensions	31 <sup>(2)</sup>	32 <sup>(2)</sup>	33	34
<b>Enclosure type</b>			IP55/IP66	IP55/IP66	IP20	IP20
<b>Voltage</b>	230V		15 to 22kW 20 to 30HP	30 to 37kW 40 to 50HP	18.5 to 22kW 25 to 30HP	30 to 37kW 40 to 50HP
	400V		30 to 45kW 40 to 60HP	55 to 75kW 75 to 100HP	37 to 45kW 50 to 60HP	55 to 75kW 75 to 100HP
<b>Height</b>	Height of backplate	A	680	770	550	660
	Height with de-coupling plate	A	-	-	630	800
	Distance between mounting holes	a	650	740	520	630
<b>Width</b>	Width of backplate	B	310	370	310	370
	Distance between mounting holes	b	270	335	270	330
<b>Depth</b>	Depth without I/O and/or network option	C	310	335	335	335
	Depth with I/O and/or network option	C	310	335	335	335
<b>Screw holes</b>		c	12.5	12.5	-	-
		d	19.0	19.0	-	-
		e	9.0	9.0	8.5	8.5
		f	9.8	9.8	17.0	17.0
<b>Weight (kg)</b>			45	65	35	50

### Dimensions IP20 open chassis drives with field installed IP21 kits<sup>(1)</sup> (mm)

Unit Size	12	13	23	24	33	34
<b>Enclosure type</b>	IP20 open chassis with IP21 kit					
<b>Voltage</b>						
230V	0.25 to 2.2kW 1/3 to 3HP	3.7kW 5HP	5.5 to 7.5kW 7.5 to 10HP	11 to 15kW 15 to 20HP	18.5 to 22kW 25 to 30HP	30 to 37kW 40 to 50HP
400V	0.25 to 2.2kW 1/2 to 5HP	5.5 to 7.5kW 7.5 to 10HP	11 to 15kW 15 to 20HP	18.5 to 30kW 25 to 40HP	37 to 45kW 50 to 60HP	55 to 75kW 75 to 100HP
<b>Height</b>	Height with kit					
	375	375	475	671	754	950
<b>Width</b>	Width of backplate					
	94	130	165	231	397	371
	Distance between mounting holes					
	70	110	140	201	269	330
<b>Depth</b>	Depth without I/O and/or network option					
	205	205	249	242	338	338
	Depth with I/O and/or network option					
	220	220	262	242	338	338

(1) Please consult IP21 kit Instructions for further mounting details and dimensions.

(2) IP55/IP66 units need to have cable glands according table below (Cable entry overview)

Note: please allow 5cm between drives with field installed IP21 kits. Also, please consult the relevant AF-6 Series drives operating instructions for recommended clearance above and below each drive rating.

### Cable entry overview

Unit Size	Enclosure type		Ø26.3	Ø33.1	Ø42.9	knock-outs	Prefix holes
15	IP55	Hole sizes to fit the cable glands	4	-	-	2*26.3	2
15	IP66		4	-	-	2*26.3	2
21	IP55		1	3	-	1*21.5 - 1*17,2	2
21	IP66		1	3	-	1*21.5 - 1*17,2	2
22	IP55		1	1	2	1*21,6	3
22	IP66		1	1	2	1*21,6	3
31	IP55 (400V)		2	1	1	0	-
31	IP55 (200V)		2	2	-	0	-
32	IP55		2	-	2	0	-

Dimensional drawings in mm (inches)

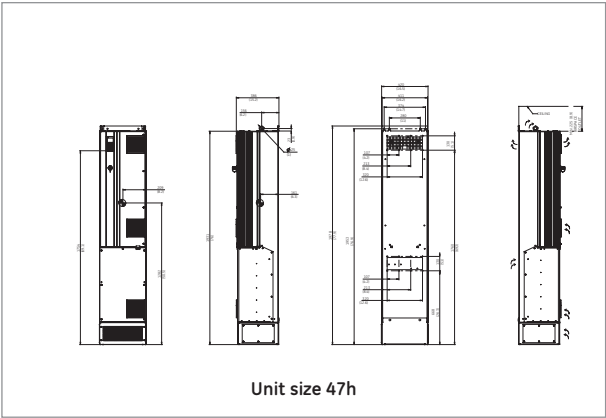
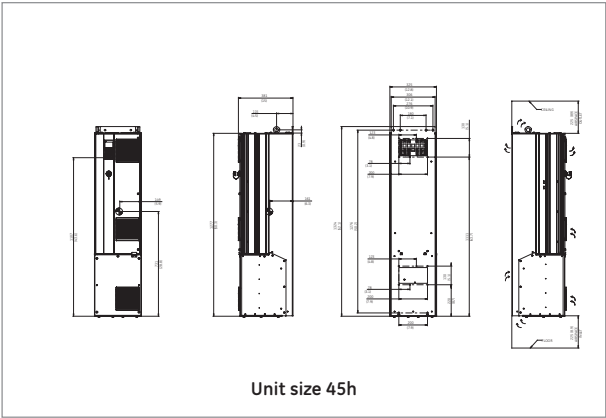
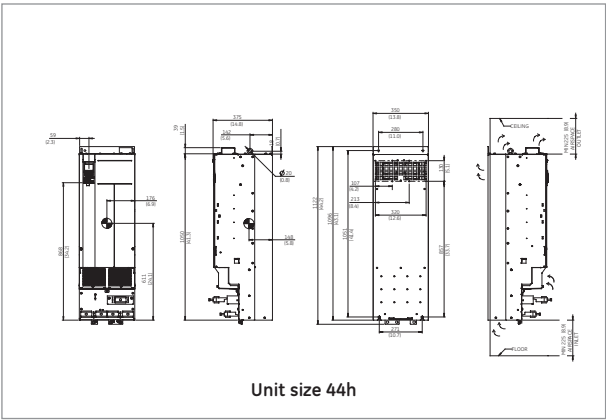
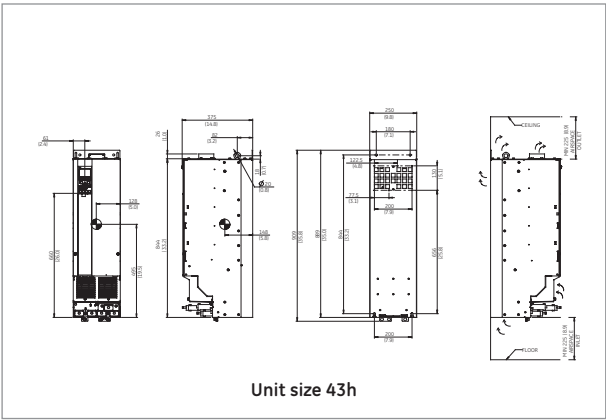
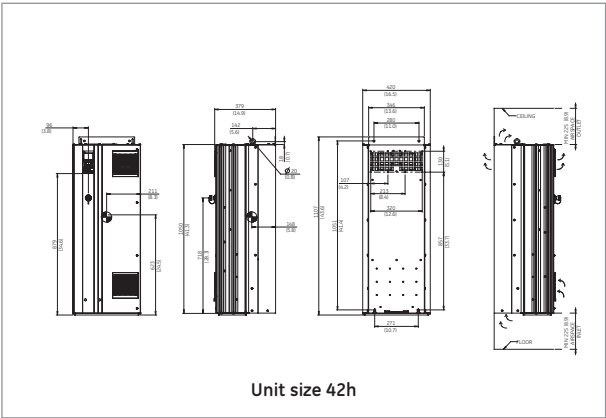
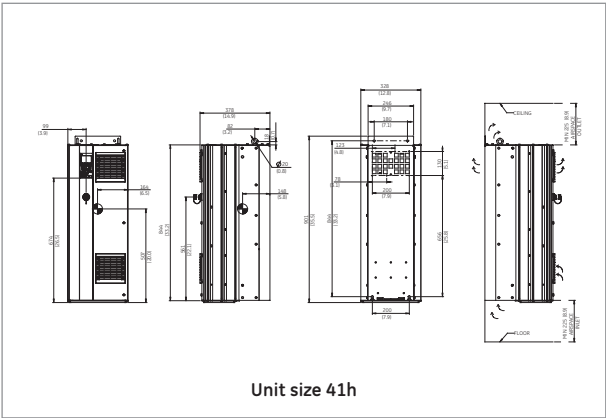

Unit size		41h	42h	43h	44h	45h	47h
<b>Enclosure type</b>		IP21/IP54	IP21/IP54	IP20	IP20	IP21/IP54	IP21/IP54
<b>Voltage</b>	400V	90 to 132kW 125 to 260HP	160 to 250kW 250 to 350HP	90 to 132kW 125 to 200HP	160 to 250kW 250 to 350HP	90 to 132kW 125 to 200HP	160 to 250kW 250 to 350HP
	690V	90 to 132kW 125 to 200HP	160 to 315kW 250 to 450HP	90 to 132kW 125 to 200HP	160 to 315kW 250 to 450HP	90 to 132kW 125 to 200HP	160 to 315kW 250 to 450HP
<b>Shipping dimensions</b>	Height	590	590	590	590	660	660
	Width	1000	1170	1000	1170	1820	2470
	Depth	460	535	460	535	510	590
<b>Drive dimensions</b>	Height	901	1107	909	1122	1324	1978
	Width	325	420	250	350	325	420
	Depth	378	379	375	375	381	386
<b>Weight (kg)</b>		98	164	98	164	116	200

With braking chopper



## Dimensional drawings in mm (inches)

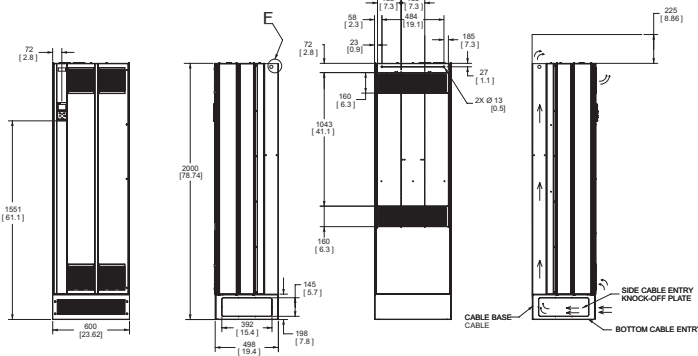

Unit size 51, IP21 and IP54

### Unit size 51

<b>Enclosure type</b>	IP21/IP54
<b>Voltage 400V</b>	250 to 400kW 350 to 550HP
<b>690V</b>	355 to 560kW 500 to 750HP
<b>Shipping dimensions</b>	
Height	841
Width	2197
Depth	734
<b>Drive dimensions</b>	
Height	2000
Width	600
Depth	498
<b>Weight (kg)</b>	313

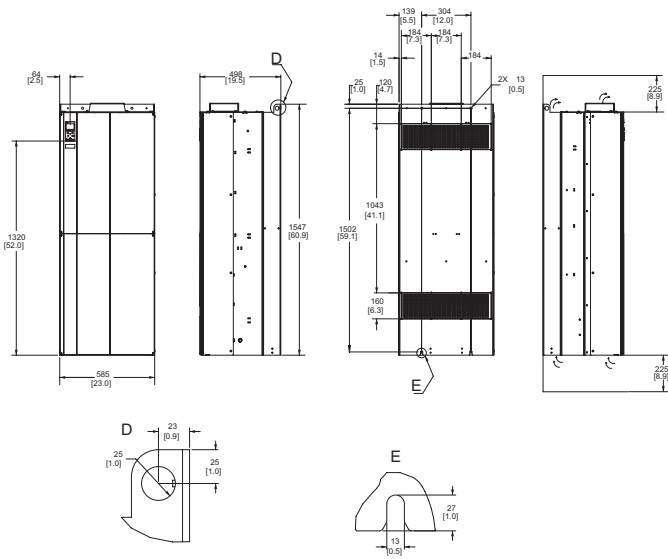

Unit size 52, IP00/Chassis

### Unit size 52

<b>Enclosure type</b>	IP00
<b>Voltage 400V</b>	250 to 400kW 350 to 550HP
<b>690V</b>	355 to 560kW 500 to 750HP
<b>Shipping dimensions</b>	
Height	831
Width	1704
Depth	734
<b>Drive dimensions</b>	
Height	1547
Width	585
Depth	498
<b>Weight (kg)</b>	313

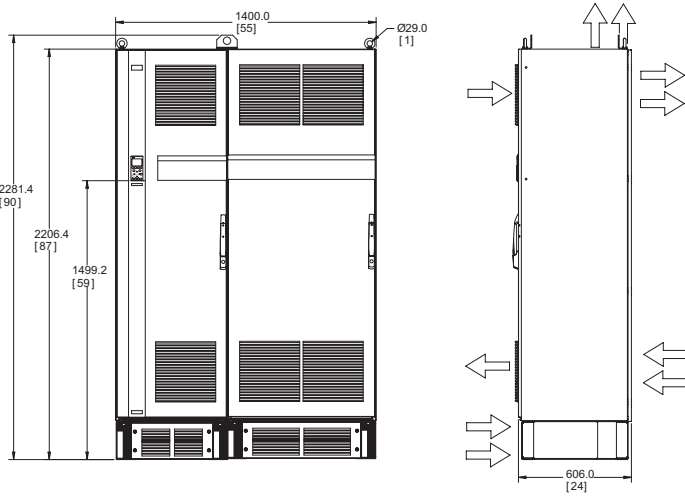

Unit Size 61

### Unit size 61

<b>Enclosure type</b>	IP21/IP54
<b>Voltage 400V</b>	450 to 630kW 600 to 900HP
<b>690V</b>	630 to 800kW 900 to 1150HP
<b>Shipping dimensions</b>	
Height	2324
Width	1570
Depth	927
<b>Drive dimensions</b>	
Height	2282
Width	1400
Depth	606
<b>Weight (kg)</b>	1004



Dimensional drawings in mm (inches)

**Unit size 62**

<b>Enclosure type</b>	IP21/IP55
<b>Voltage</b> 400V	710 to 800kW 1000 to 1200HP
690V	900 to 1000kW 1250 to 1350HP
<b>Shipping dimensions</b>	
Height	2324
Width	1961
Depth	419
<b>Drive dimensions</b>	
Height	2282
Width	1800
Depth	606
<b>Weight (kg)</b>	1262

**Unit size 63**

<b>Enclosure type</b>	IP21/IP55
<b>Voltage</b> 400V	450 to 630kW 600 to 900HP
690V	630 to 800kW 900 to 1150HP
<b>Shipping dimensions</b>	
Height	2324
Width	2159
Depth	927
<b>Drive dimensions</b>	
Height	2282
Width	2000
Depth	606
<b>Weight (kg)</b>	1300

**Unit size 64**

<b>Enclosure type</b>	IP21/IP55
<b>Voltage</b> 400V	710 to 800kW 1000 to 1200HP
690V	900 to 1000kW 1250 to 1350HP
<b>Shipping dimensions</b>	
Height	2324
Width	2543
Depth	927
<b>Drive dimensions</b>	
Height	2282
Width	2400
Depth	606
<b>Weight (kg)</b>	1541





## AF-600 FP - Fan and Pump Drives

The AF-600 FP Fan and Pump Drive is a powerful, flexible and easy to use AC variable torque drive.

The drive is available in its standard configuration that includes LCD keypad display that can be remote mounted, DC link reactors, built-in Modbus RTU, Metasys N2, Apogee FLN P1 and RFI Class A2 filter. Available in IP55/IP66 enclosure.

Following models are available:

- Three-phase, 230Vac, from 0.75 to 45kW
- Three-phase, 400Vac, from 0.75 to 1000kW
- Three-phase, 690Vac, from 1.1 to 1400kW

### Features

All features HVAC needs

- RFI class A2 filter and DC link reactor as standard configuration.
- Built-in communication networks for ModBus RTU, Metasys N2 and Apogee FLN P1
- Field installed network options: BACnet, LonWorks, Profibus DP, Profinet, Modbus TCP/IP, Ethernet/IP and DeviceNet
- 110% current overload for 1 minute (Light Duty)
- Hot pluggable, illuminated LCD display, unit indications, rotation direction indication, trended charts display speed, torque, current, full alarm messages & descriptions
- 4 auto-tuning PID controllers
- Integrated logic control, PLC
- "Pick up" start (catch a spinning motor)
- Easy to use PC software
- Energy monitoring feature
- Flow compensation
- Pump cascade controller
- Sleep mode
- Fan belt monitoring
- Stairwell pressurization
- Fire override mode
- High standard protection Class 3C2, optional class 3C3

### Approvals / Marking



UL, cUL, C-Tick

### Applications

#### Fan

HVAC, cooling towers, VAV, supply and return, exhaust, fume hood, make-up air, induced and forced draft, furnace temperature control.

#### Pump

Chilled water, pressure boosting, cooling tower, wastewater, chiller, irrigation, hydro-storage.

### Product numbering system diagram

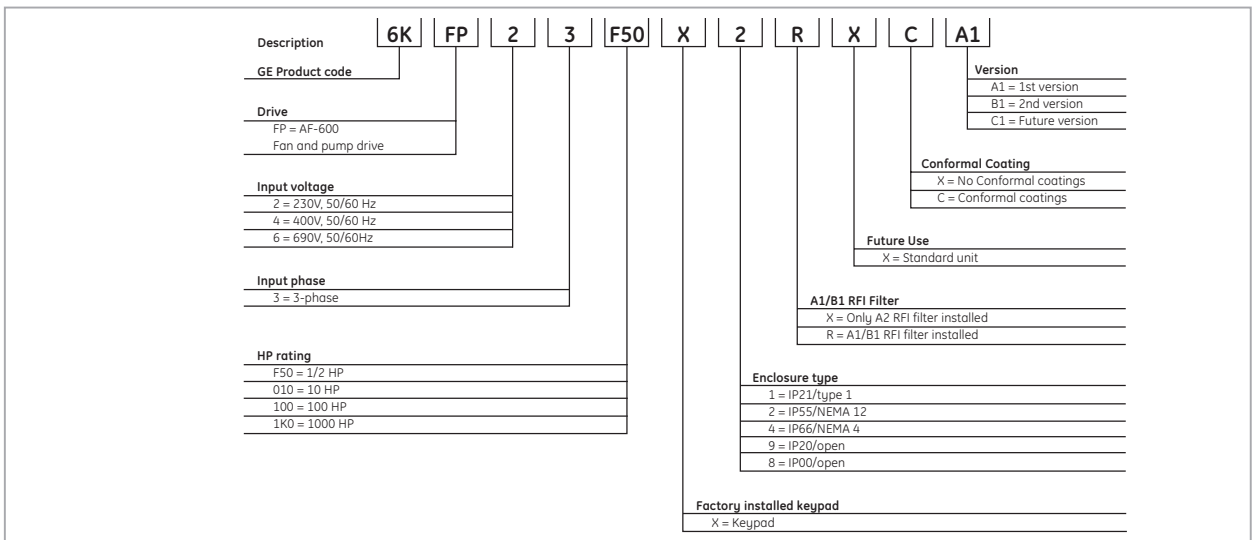

Product number for illustrative purposes only



**IP00 / IP20 / IP21, with EMC filter Class A2 (C3)  
230V, 3-phase, 50/60Hz input**

Nominal motor ratings			Enclosure type <sup>(2)</sup> :	Cat. No.	Ref. No.	Unit size
Power kW	Current A	Overload current (A) (110% 1 Min)				
0.75	4.6	5.1	IP20	6KFP23001X9XXXXA1	404684	12
1.5	7.5	8.3		6KFP23002X9XXXXA1	404685	12
2.2	10.6	11.7		6KFP23003X9XXXXA1	404686	12
3.7	16.7	18.4		6KFP23005X9XXXXA1	404687	13
5.5	24.2	26.6		6KFP23007X9XXXXA1	404688	23
7.5	30.8	33.9		6KFP23010X9XXXXA1	404689	23
11	46.2	50.8		6KFP23015X9XXXXA1	404690	23
15	59.4	65.3		6KFP23020X9XXXXA1	404691	24
18.5	74.8	82.3		6KFP23025X9XXXXA1	404692	24
22	88	96.8		6KFP23030X9XXXXA1	404693	33
30	115	126.5		6KFP23040X9XXXXA1	404694	33
37	143	157		6KFP23050X9XXXXA1	404695	34
45	170	187		6KFP23060X9XXXXA1	404696	34

**400V, 3-phase, 50/60Hz input**

Nominal motor ratings			Enclosure type <sup>(2)</sup> :	Cat. No.	Ref. No.	Unit size
Power kW	Current A	Overload current (A) (110% 1 Min)				
0.75	2.4	2.64	IP20	6KFP43001X9XXXXA1	403855	12
1.5	4.1	4.51		6KFP43002X9XXXXA1	403856	12
2.2	5.6	6.16		6KFP43003X9XXXXA1	403857	12
4	10	11		6KFP43005X9XXXXA1	403858	12
5.5	13	14.3		6KFP43007X9XXXXA1	403859	13
7.5	16	17.6		6KFP43010X9XXXXA1	403860	13
11	32	35.2		6KFP43015X9XXXXA1	403861	23
15	37.5	41.25		6KFP43020X9XXXXA1	403862	23
18.5	44	48.4		6KFP43025X9XXXXA1	403863	23
22	61	67.1		6KFP43030X9XXXXA1	403864	24
30	73	80.3		6KFP43040X9XXXXA1	403865	24
37	90	99		6KFP43050X9XXXXA1	403866	24
45	106	116.6		6KFP43060X9XXXXA1	403867	33
55	147	161.7		6KFP43075X9XXXXA1	403868	33
75	177	194.7		6KFP43100X9XXXXA1	403869	34
90	212	233.2		6KFP43125X9XXXXA1	403870	34
110	260	286	IP20 conformal coated	6KFP43150X9XXCB1	409679	43h
132	315	346.5		6KFP43200X9XXCB1	409680	43h
160	395	434.5		6KFP43250X9XXCB1	409682	43h
200	480	528		6KFP43300X9XXCB1	409683	44h
250	600	660	IP00 conformal coated	6KFP43350X9XXCB1	409684	44h
315	658	723.8		6KFP43450X9XXCB1	409685	44h
355	745	819.5		6KFP43500X8XXCA1	403877	52
400	800	880		6KFP43550X8XXCA1	403878	52
450	880	968	IP21 conformal coated	6KFP43600X8XXCA1	403879	52
500	990	1089		6KFP43650X1XXCA1	403880	61
560	1120	1232		6KFP43750X1XXCA1	403881	61
630	1260	1386		6KFP43900X1XXCA1	403882	61
710	1460	1606	IP21 conformal coated	6KFP431K0X1XXCA1	403883	61
800	1700	1870		6KFP431K2X1XXCA1	403884	62
1000	-	-		6KFP431K3X1XXCA1	403885	62

**690V, 3-phase, 50/60Hz input**

Nominal motor ratings			Enclosure type <sup>(2)</sup> :	Cat. No.	Ref. No.	Unit size	
Power kW	Current A	Overload current (A) (110% 1 Min)					
11	13	14	IP21 conformal coated	6KFP63015X1XXCA1	404866	-	
15	18	20		6KFP63020X1XXCA1	404870	-	
18.5	22	24		6KFP63025X1XXCA1	404874	-	
22	27	30		6KFP63030X1XXCA1	404878	-	
30	34	37		6KFP63040X1XXCA1	404882	-	
37	41	45		6KFP63050X1XXCA1	404886	-	
45	52	57		6KFP63060X1XXCA1	404890	-	
55	62	68		6KFP63075X1XXCA1	404894	-	
75	83	91		6KFP63100X1XXCA1	404898	-	
90	100	110		6KFP63125X1XXCA1	404902	-	
110	131	144		IP20 conformal coated	6KFP63150X9XXCB1	-	-
132	155	171			6KFP63200X9XXCB1	-	-
160	192	211			6KFP63250X9XXCB1	-	-
200	242	266			6KFP63300X9XXCB1	-	-
250	290	319		IP00 conformal coated	6KFP63350X9XXCB1	-	-
315	344	378			6KFP63450X9XXCB1	-	-
355	400	440	6KFP63550X9XXCB1		-	-	
400	450	495	6KFP63600X8XXCA1		-	-	
500	500	550	IP21 conformal coated	6KFP63650X8XXCA1	on request	-	
560	570	627		6KFP63750X8XXCA1	-	-	
630	630	693		6KFP63900X8XXCA1	-	-	
710	730	803		6KFP631K0X1XXCA1	-	-	
800	850	935	IP21 conformal coated	6KFP631K1X1XXCA1	-	-	
900	945	1040		6KFP631K2X1XXCA1	-	-	
1000	1060	1166		6KFP631K3X1XXCA1	-	-	
1200	1260	1386		6KFP631K6X1XXCA1	-	-	
1400	1415	1557		6KFP631K9X1XXCA1	-	-	

(1) Drives are rated IP21 without the need for a separate kit.

(2) IP21 kits are available as field installed options for all 230V drives from 1.1 to 45kW and for all 400V drives from 1.1 to 90kW. See page 39.



## IP00 / IP20 / IP21, with EMC filter Class A1/B1 (C1/C2) 230V, 3-phase, 50/60Hz input

Nominal motor ratings			Enclosure type <sup>(2)</sup> :	Cat. No.	Ref. No.	Unit size
Power kW	Current A	Overload current (A) (110% 1 Min)				
0.75	4.6	5.1	IP20	6KFP23001X9RXXA1	on request	12
1.5	7.5	8.3		6KFP23002X9RXXA1		12
2.2	10.6	11.7		6KFP23003X9RXXA1		12
3.7	16.7	18.4		6KFP23005X9RXXA1		13
5.5	24.2	26.6		6KFP23007X9RXXA1		23
7.5	30.8	33.9		6KFP23010X9RXXA1		23
11	46.2	50.8		6KFP23015X9RXXA1		23
15	59.4	65.3		6KFP23020X9RXXA1		24
18.5	74.8	82.3		6KFP23025X9RXXA1		24
22	88	96.8		6KFP23030X9RXXA1		33
30	115	126.5		6KFP23040X9RXXA1		33
37	143	157		6KFP23050X9RXXA1		34
45	170	187		6KFP23060X9RXXA1		34

## 400V, 3-phase, 50/60Hz input

Nominal motor ratings			Enclosure type <sup>(2)</sup> :	Cat. No.	Ref. No.	Unit size
Power kW	Current A	Overload current (A) (110% 1 Min)				
0.75	1.3	1.43	IP20	6KFP43001X9RXXA1	403973	12
1.5	2.4	2.64		6KFP43002X9RXXA1	403974	12
2.2	4.1	4.51		6KFP43003X9RXXA1	403975	12
4	5.6	6.16		6KFP43005X9RXXA1	403976	12
5.5	10	11		6KFP43007X9RXXA1	403977	13
7.5	13	14.3		6KFP43010X9RXXA1	403978	13
11	16	17.6		6KFP43015X9RXXA1	403979	23
15	32	35.2		6KFP43020X9RXXA1	403980	23
18.5	37.5	41.25		6KFP43025X9RXXA1	403981	23
22	44	48.4		6KFP43030X9RXXA1	403982	24
30	61	67.1		6KFP43040X9RXXA1	403983	24
37	73	80.3		6KFP43050X9RXXA1	403984	24
45	90	99		6KFP43060X9RXXA1	403985	33
55	106	116.6		6KFP43075X9RXXA1	403986	33
75	147	161.7		6KFP43100X9RXXA1	403987	34
90	177	194.7		6KFP43125X9RXXA1	403988	34
110	212	233.2	IP20 conformal coated	6KFP43150X9RXC1	409692	43h
132	260	286		6KFP43200X9RXC1	409693	43h
160	315	346.5	IP00 conformal coated	6KFP43250X9RXC1	409694	43h
200	395	434.5		6KFP43300X9RXC1	409695	44h
250	480	528	IP21 conformal coated	6KFP43350X9RXC1	409700	44h
315	600	660		6KFP43450X9RXC1	409702	44h
355	658	723.8	IP00 conformal coated	6KFP43500X8RXC1	403995	52
400	745	819.5		6KFP43550X8RXC1	403996	52
450	800	880	IP21 conformal coated	6KFP43600X8RXC1	403997	52
500	880	968		6KFP43650X1RXC1	403998	63
560	990	1089	IP21 conformal coated	6KFP43750X1RXC1	403999	63
630	1120	1232		6KFP43900X1RXC1	404000	63
710	1260	1386	IP21 conformal coated	6KFP431K0X1RXC1	404205	63
800	1460	1606		6KFP431K2X1RXC1	404206	64
1000	1700	1870		6KFP431K3X1RXC1	404208	61

## 690V, 3-phase, 50/60Hz input

Nominal motor ratings			Enclosure type <sup>(2)</sup> :	Cat. No.	Ref. No.	Unit size	
Power kW	Current A	Overload current (A) (110% 1 Min)					
11	13	14	IP21 conformal coated	6KFP63015X1RXC1	404865	-	
15	18	20		6KFP63020X1RXC1	404869	-	
18.5	22	24		6KFP63025X1RXC1	404873	-	
22	27	30		6KFP63030X1RXC1	404877	-	
30	34	37		6KFP63040X1RXC1	404881	-	
37	41	45		6KFP63050X1RXC1	404885	-	
45	52	57		6KFP63060X1RXC1	404889	-	
55	62	68		6KFP63075X1RXC1	404893	-	
75	83	91		6KFP63100X1RXC1	404897	-	
90	100	110		6KFP63125X1RXC1	404901	-	
110	131	144		IP20 conformal coated	6KFP63150X9RXC1	on request	
132	155	171			6KFP63200X9RXC1		
160	192	211		IP00 conformal coated	6KFP63250X9RXC1	on request	
200	242	266			6KFP63300X9RXC1		
250	290	319		IP21 conformal coated	6KFP63350X9RXC1	on request	
315	344	378			6KFP63450X9RXC1		
355	400	440	IP00 conformal coated	6KFP63550X9RXC1	on request		
400	450	495		6KFP63600X8RXC1			
500	500	550	IP21 conformal coated	6KFP63650X8RXC1	on request		
560	570	627		6KFP63750X8RXC1			
630	630	693	IP21 conformal coated	6KFP63900X8RXC1	on request		
710	730	803		6KFP631K0X1RXC1			
800	850	935	IP21 conformal coated	6KFP631K1X1RXC1	on request		
900	945	1040		6KFP631K2X1RXC1			
1000	1060	1166		6KFP631K3X1RXC1			
1200	1260	1386		6KFP631K6X1RXC1			
1400	1415	1557		6KFP631K9X1RXC1			

(1) Drives are rated IP21 without the need for a separate kit.

(2) IP21 kits are available as field installed options for all 230V drives from 1.1 to 45kW and for all 400V drives from 1.1 to 90kW. See page 39.



**IP54 / IP55, with EMC filter Class A2 (C3)**  
**230V, 3-phase, 50/60Hz input**

Nominal motor ratings			Enclosure type <sup>(2)</sup> :	Cat. No.	Ref. No.	Unit size
Power kW	Current A	Overload current (A) (110% 1 Min)				
0.75	4.6	5.1	IP55	6KFP23001X2XXXA1	404697	12
1.5	7.5	8.3		6KFP23002X2XXXA1	404698	12
2.2	10.6	11.7		6KFP23003X2XXXA1	404699	12
3.7	16.7	18.4		6KFP23005X2XXXA1	404700	13
5.5	24.2	26.6		6KFP23007X2XXXA1	404701	23
7.5	30.8	33.9		6KFP23010X2XXXA1	404702	23
11	46.2	50.8		6KFP23015X2XXXA1	404703	23
15	59.4	65.3		6KFP23020X2XXXA1	404704	24
18.5	74.8	82.3		6KFP23025X2XXXA1	404705	24
22	88	96.8		6KFP23030X2XXXA1	404706	33
30	115	126.5		6KFP23040X2XXXA1	404707	33
37	143	157		6KFP23050X2XXXA1	404708	34
45	170	187		6KFP23060X2XXXA1	404709	34

**400V, 3-phase, 50/60Hz input**

Nominal motor ratings			Enclosure type <sup>(2)</sup> :	Cat. No.	Ref. No.	Unit size
Power kW	Current A	Overload current (A) (110% 1 Min)				
0.75	1.3	1.43	IP55	6KFP43001X2XXXA1	403886	15
1.5	2.4	2.64		6KFP43002X2XXXA1	403887	15
2.2	4.1	4.51		6KFP43003X2XXXA1	403888	15
4	5.6	6.16		6KFP43005X2XXXA1	403889	15
5.5	10	11		6KFP43007X2XXXA1	403890	15
7.5	13	14.3		6KFP43010X2XXXA1	403891	15
11	16	17.6		6KFP43015X2XXXA1	403892	15
15	32	35.2		6KFP43020X2XXXA1	403893	21
18.5	37.5	41.25		6KFP43025X2XXXA1	403894	21
22	44	48.4		6KFP43030X2XXXA1	403895	22
30	61	67.1		6KFP43040X2XXXA1	403896	22
37	73	80.3		6KFP43050X2XXXA1	403897	31
45	90	99		6KFP43060X2XXXA1	403898	31
55	106	116.6		6KFP43075X2XXXA1	403899	31
75	147	161.7		6KFP43100X2XXXA1	403900	32
90	177	194.7		6KFP43125X2XXXA1	403901	32
110	212	233.2	IP54 conformal coated	6KFP43150X2XXCB1	409686	41h
132	260	286		6KFP43200X2XXCB1	409687	41h
160	315	346.5		6KFP43250X2XXCB1	409688	41h
200	395	434.5		6KFP43300X2XXCB1	409689	42h
250	480	528		6KFP43350X2XXCB1	409690	42h
315	600	660		6KFP43400X2XXCB1	409691	42h
355	658	723.8		6KFP43500X2XXCA1	403908	52
400	745	819.5		6KFP43550X2XXCA1	403909	52
450	800	880		6KFP43600X2XXCA1	403910	52
500	880	968		6KFP43650X2XXCA1	403911	61
560	990	1089		6KFP43750X2XXCA1	403912	61
630	1120	1232		6KFP43900X2XXCA1	403913	61
710	1260	1386		6KFP431K0X2XXCA1	403914	61
800	1460	1606		6KFP431K2X2XXCA1	403915	62
1000	1700	1870	6KFP431K3X2XXCA1	403916	62	

**690V, 3-phase, 50/60Hz input**

Nominal motor ratings			Enclosure type <sup>(2)</sup> :	Cat. No.	Ref. No.	Unit size	
Power kW	Current A	Overload current (A) (110% 1 Min)					
11	13	14.3	IP55 conformal coated	6KFP63015X2XXCA1	404868	-	
15	18	19.8		6KFP63020X2XXCA1	404872	-	
18.5	22	24.2		6KFP63025X2XXCA1	404876	-	
22	27	29.7		6KFP63030X2XXCA1	404880	-	
30	34	37.4		6KFP63040X2XXCA1	404884	-	
37	41	45.1		6KFP63050X2XXCA1	404888	-	
45	52	57.2		6KFP63060X2XXCA1	404892	-	
55	62	68.2		6KFP63075X2XXCA1	404896	-	
75	83	91.3		6KFP63100X2XXCA1	404900	-	
90	100	110.0		6KFP63125X2XXCA1	404904	-	
110	155	171		IP54 conformal coated	6KFP63150X2XXCB1	-	-
132	192	211			6KFP63200X2XXCB1	-	-
160	242	266			6KFP63250X2XXCB1	-	-
200	290	319			6KFP63300X2XXCB1	-	-
250	344	378			6KFP63350X2XXCB1	-	-
315	400	440			6KFP63400X2XXCB1	-	-
355	450	495	6KFP63500X2XXCA1		-	-	
400	500	550	6KFP63550X2XXCA1		-	on request	
500	570	627	6KFP63650X2XXCA1		-	-	
560	630	693	6KFP63750X2XXCA1		-	-	
630	730	803	6KFP63900X2XXCA1		-	-	
710	850	935	6KFP631K0X2XXCA1		-	-	
800	945	1040	6KFP631K1X2XXCA1		-	-	
900	1060	1166	6KFP631K2X2XXCA1		-	-	
1000	1260	1386	6KFP631K3X2XXCA1	-	-		
1200	1415	1557	6KFP631K6X2XXCA1	-	-		

(1) Drives are rated IP21 without the need for a separate kit.  
 (2) IP21 kits are available as field installed options for all 230V drives from 1.1 to 45kW and for all 400V drives from 1.1 to 90kW. See page 39.



## IP54 / IP55, with EMC filter Class A1/B1 (C1/C2) 230V, 3-phase, 50/60Hz input

Nominal motor ratings			Enclosure type <sup>(2)</sup> :	Cat. No.	Ref. No.	Unit size
Power kW	Current A	Overload current (A) (110% 1 Min)				
0.75	4.6	5.1	IP55	6KFP23001X2RXXA1	on request	12
1.5	7.5	8.3		6KFP23002X2RXXA1		12
2.2	10.6	11.7		6KFP23003X2RXXA1		12
3.7	16.7	18.4		6KFP23005X2RXXA1		13
5.5	24.2	26.6		6KFP23007X2RXXA1		23
7.5	30.8	33.9		6KFP23010X2RXXA1		23
11	46.2	50.8		6KFP23015X2RXXA1		23
15	59.4	65.3		6KFP23020X2RXXA1		24
18.5	74.8	82.3		6KFP23025X2RXXA1		24
22	88	96.8		6KFP23030X2RXXA1		33
30	115	126.5		6KFP23040X2RXXA1		33
37	143	157		6KFP23050X2RXXA1		34
45	170	187		6KFP23060X2RXXA1		34

## 400V, 3-phase, 50/60Hz input

Nominal motor ratings			Enclosure type <sup>(2)</sup> :	Cat. No.	Ref. No.	Unit size
Power kW	Current A	Overload current (A) (110% 1 Min)				
0.75	1.3	1.43	IP55	6KFP43001X2RXXA1	404209	12
1.5	2.4	2.64		6KFP43002X2RXXA1	404210	12
2.2	4.1	4.51		6KFP43003X2RXXA1	404263	12
4	5.6	6.16		6KFP43005X2RXXA1	404293	12
5.5	10	11		6KFP43007X2RXXA1	404387	13
7.5	13	14.3		6KFP43010X2RXXA1	404388	13
11	16	17.6		6KFP43015X2RXXA1	404389	23
15	32	35.2		6KFP43020X2RXXA1	404464	23
18.5	37.5	41.25		6KFP43025X2RXXA1	404465	23
22	44	48.4		6KFP43030X2RXXA1	404466	24
30	61	67.1		6KFP43040X2RXXA1	404467	24
37	73	80.3		6KFP43050X2RXXA1	404468	24
45	90	99		6KFP43060X2RXXA1	404469	33
55	106	116.6		6KFP43075X2RXXA1	404470	33
75	147	161.7		6KFP43100X2RXXA1	404471	34
90	177	194.7		6KFP43125X2RXXA1	404472	34
110	212	233.2	6KFP43150X2RXXCB1	409703	41h	
132	260	286	6KFP43200X2RXXCB1	409704	41h	
160	315	346.5	6KFP43250X2RXXCB1	409705	41h	
200	395	434.5	6KFP43300X2RXXCB1	409706	42h	
250	480	528	6KFP43350X2RXXCB1	409707	42h	
315	600	660	6KFP43450X2RXXCB1	409708	42h	
355	658	723.8	6KFP43500X2RXXCA1	404528	52	
400	745	819.5	6KFP43550X2RXXCA1	404529	52	
450	800	880	6KFP43600X2RXXCA1	404532	52	
500	880	968	6KFP43650X2RXXCA1	404533	63	
560	990	1089	6KFP43750X2RXXCA1	404534	63	
630	1120	1232	6KFP43900X2RXXCA1	404535	63	
710	1260	1386	6KFP431K0X2RXXCA1	404536	63	
800	1460	1606	6KFP431K2X2RXXCA1	404537	64	
1000	1700	1870	6KFP431K3X2RXXCA1	404538	64	

## 690V, 3-phase, 50/60Hz input

Nominal motor ratings			Enclosure type <sup>(2)</sup> :	Cat. No.	Ref. No.	Unit size
Power kW	Current A	Overload current (A) (110% 1 Min)				
11	13	14.3	IP55 conformal coated	6KFP63015X2RXXCA1	404867	-
15	18	19.8		6KFP63020X2RXXCA1	404871	-
18.5	22	24.2		6KFP63025X2RXXCA1	404875	-
22	27	29.7		6KFP63030X2RXXCA1	404879	-
30	34	37.4		6KFP63040X2RXXCA1	404883	-
37	41	45.1		6KFP63050X2RXXCA1	404887	-
45	52	57.2		6KFP63060X2RXXCA1	404891	-
55	62	68.2		6KFP63075X2RXXCA1	404895	-
75	83	91.3		6KFP63100X2RXXCA1	404899	-
90	100	110.0		6KFP63125X2RXXCA1	404903	-
110	155	171		6KFP63150X2RXXCB1	-	-
132	192	211		6KFP63200X2RXXCB1	-	-
160	242	266		6KFP63250X2RXXCB1	-	-
200	290	319		6KFP63300X2RXXCB1	-	-
250	344	378		6KFP63350X2RXXCB1	-	-
315	400	440		6KFP63400X2RXXCB1	-	-
355	450	495	6KFP63500X2RXXCA1	-	-	
400	500	550	6KFP63550X2RXXCA1	-	-	
500	570	627	6KFP63650X2RXXCA1	on request	-	
560	630	693	6KFP63750X2RXXCA1	-	-	
630	730	803	6KFP63900X2RXXCA1	-	-	
710	850	935	6KFP631K0X2RXXCA1	-	-	
800	945	1040	6KFP631K1X2RXXCA1	-	-	
900	1060	1166	6KFP631K2X2RXXCA1	-	-	
1000	1260	1386	6KFP631K3X2RXXCA1	-	-	
1200	1415	1557	6KFP631K6X2RXXCA1	-	-	

(1) Drives are rated IP21 without the need for a separate kit.

(2) IP21 kits are available as field installed options for all 230V drives from 1.1 to 45kW and for all 400V drives from 1.1 to 90kW. See page 39.



**IP66, with EMC filter Class A2 (C3)**

**230V, 3-phase, 50/60Hz input**

Nominal motor ratings			Overload current (A) (110% 1 Min)	Enclosure type <sup>(2)</sup> :	Cat. No.	Ref. No.	Unit size
Power kW	Current A						
0.75	4.6	5.1	IP66	6KFP23001X4XXXXA1	on request		
1.5	7.5	8.3		6KFP23002X4XXXXA1			
2.2	10.6	11.7		6KFP23003X4XXXXA1			
3.7	16.7	18.4		6KFP23005X4XXXXA1			
5.5	24.2	26.6		6KFP23007X4XXXXA1			
7.5	30.8	33.9		6KFP23010X4XXXXA1			
11	46.2	50.8		6KFP23015X4XXXXA1			
15	59.4	65.3		6KFP23020X4XXXXA1			
18.5	74.8	82.3		6KFP23025X4XXXXA1			
22	88	96.8		6KFP23030X4XXXXA1			
30	115	126.5		6KFP23040X4XXXXA1			
37	143	157		6KFP23050X4XXXXA1			
45	170	187		6KFP23060X4XXXXA1			

**400V, 3-phase, 50/60Hz input**

Nominal motor ratings			Overload current (A) (110% 1 Min)	Enclosure type <sup>(2)</sup> :	Cat. No.	Ref. No.	Unit size
Power kW	Current A						
0.75	1.3	1.43	IP66	6KFP43001X4XXXXA1	on request		
1.5	2.4	2.64		6KFP43002X4XXXXA1			
2.2	4.1	4.51		6KFP43003X4XXXXA1			
4	5.6	6.16		6KFP43005X4XXXXA1			
5.5	10	11		6KFP43007X4XXXXA1			
7.5	13	14.3		6KFP43010X4XXXXA1			
11	16	17.6		6KFP43015X4XXXXA1			
15	32	35.2		6KFP43020X4XXXXA1			
18.5	37.5	41.25		6KFP43025X4XXXXA1			
22	44	48.4		6KFP43030X4XXXXA1			
30	61	67.1		6KFP43040X4XXXXA1			
37	73	80.3		6KFP43050X4XXXXA1			
45	90	99		6KFP43060X4XXXXA1			
55	106	116.6		6KFP43075X4XXXXA1			
75	147	161.7		6KFP43100X4XXXXA1			
90	177	194.7		6KFP43125X4XXXXA1			

(1) Drives are rated IP21 without the need for a separate kit.

(2) IP21 kits are available as field installed options for all 230V drives from 1.1 to 45kW and for all 400V drives from 1.1 to 90kW. See page 39.



## IP66, with EMC filter Class A1/B1 (C1/C2)

### 230V, 3-phase, 50/60Hz input

Nominal motor ratings			Enclosure type <sup>(2)</sup> :	Cat. No.	Ref. No.	Unit size
Power kW	Current A	Overload current (A) (110% 1 Min)				
0.75	4.6	5.1	IP66	6KFP23001X4RXXA1	on request	
1.5	7.5	8.3		6KFP23002X4RXXA1		
2.2	10.6	11.7		6KFP23003X4RXXA1		
3.7	16.7	18.4		6KFP23005X4RXXA1		
5.5	24.2	26.6		6KFP23007X4RXXA1		
7.5	30.8	33.9		6KFP23010X4RXXA1		
11	46.2	50.8		6KFP23015X4RXXA1		
15	59.4	65.3		6KFP23020X4RXXA1		
18.5	74.8	82.3		6KFP23025X4RXXA1		
22	88	96.8		6KFP23030X4RXXA1		
30	115	126.5		6KFP23040X4RXXA1		
37	143	157		6KFP23050X4RXXA1		
45	170	187		6KFP23060X4RXXA1		

### 400V, 3-phase, 50/60Hz input

Nominal motor ratings			Enclosure type <sup>(2)</sup> :	Cat. No.	Ref. No.	Unit size
Power kW	Current A	Overload current (A) (110% 1 Min)				
0.75	1.3	1.43	IP66	6KFP43001X4RXXA1	on request	
1.5	2.4	2.64		6KFP43002X4RXXA1		
2.2	4.1	4.51		6KFP43003X4RXXA1		
4	5.6	6.16		6KFP43005X4RXXA1		
5.5	10	11		6KFP43007X4RXXA1		
7.5	13	14.3		6KFP43010X4RXXA1		
11	16	17.6		6KFP43015X4RXXA1		
15	32	35.2		6KFP43020X4RXXA1		
18.5	37.5	41.25		6KFP43025X4RXXA1		
22	44	48.4		6KFP43030X4RXXA1		
30	61	67.1		6KFP43040X4RXXA1		
37	73	80.3		6KFP43050X4RXXA1		
45	90	99		6KFP43060X4RXXA1		
55	106	116.6		6KFP43075X4RXXA1		
75	147	161.7		6KFP43100X4RXXA1		
90	177	194.7		6KFP43125X4RXXA1		

(1) Drives are rated IP21 without the need for a separate kit.

(2) IP21 kits are available as field installed options for all 230V drives from 1.1 to 45kW and for all 400V drives from 1.1 to 90kW. See page 39.





Options and accessories

Field installed IP21 add-on option kits



Voltage	Power kW	IP21 kit Cat. No.	Ref. No.
230	0,75	NEMA1ACA2	404831
	1,5	NEMA1ACA2	404831
	2,2	NEMA1ACA2	404831
	3,7	NEMA1ACA3	404832
	5,5	NEMA1ACB3	404833
	7,5	NEMA1ACB3	404833
	11	NEMA1ACB3	404833
	15	NEMA1ACB4	404834
	18,5	NEMA1ACB4	404834
	22	NEMA1ACC3	404835
	30	NEMA1ACC3	404835
	37	NEMA1ACC4	404836
	45	NEMA1ACC4	404836
400	0,75	NEMA1ACA2	404831
	1,5	NEMA1ACA2	404831
	2,2	NEMA1ACA2	404831
	3,7	NEMA1ACA2	404831
	5,5	NEMA1ACA3	404832
	7,5	NEMA1ACA3	404832
	11	NEMA1ACB3	404833
	15	NEMA1ACB3	404833
	18,5	NEMA1ACB3	404833
	22	NEMA1ACB4	404834
	30	NEMA1ACB4	404834
	37	NEMA1ACB4	404834
	45	NEMA1ACC3	404835
55	NEMA1ACC3	404835	
75	NEMA1ACC4	404836	
90	NEMA1ACC4	404836	

Remote mounting kit for graphical LCD keypad

Remote mounting Kit for mounting graphical LCD Keypad on enclosure door. Kit includes gasket, mounting brackets, and cable. Keypad is rated IP65.



Description	Cat. No.	Ref. No.
Remote mounting kit for graphical LCD keypad with cable (3m)	RMKYPDAC	404851
Remote mounting kit without cable	OPCRMKNC	404850

Communications modules



<b>Profibus DP communications module</b> Profibus DP internal drive mounted module for use on AF-650 GP and AF-600 FP drives. Supports Profibus DP V1 communications networks.	OPCPDP	404848
<b>DeviceNet communications module</b> DeviceNet internal drive mounted module for use on AF-650 GP and AF-600 FP drives. ODVA certified device.	OPCDEV	404818
<b>Ethernet IP communications module<sup>(1)</sup></b> Ethernet IP internal drive mounted module for use on AF-650 GP and AF-600 FP drives. ODVA certified device. Features 2-port built-in switch. Also includes webserver and e-mail notification.	OPCEIP	404820
<b>Modbus TCP communications module</b> Modbus TCP internal drive mounted module for use on AF-650 GP and AF-600 FP drives.	OPCMBTCP	404824
<b>ProfiNet RT communications module</b> ProfiNet RT internal drive mounted module for use on AF-650 GP and AF-600 FP drives.	OPCPRT	404825
<b>LonWorks communications module</b> LonWorks internal drive mounted module for use on AF-600 FP drives only. Supports LonWorks building automation communications networks.	OPCLON	404823
<b>BacNet communications module</b> BacNet internal drive mounted module for use on AF-600 FP drives only. Supports BacNet MSTP building automation communications networks.	OPCBAC	404817

(1) Requires I/O and network slots and cannot be used with any other network or I/O modules.



*Options and accessories (continued)*

**Relay output module**



Relay output internal drive mounted module for use on AF-600 drives. Module adds (3) Form C relay outputs to the drive. Relays are rated at 2A at 240V resistive load.

Description	Cat. No.	Ref. No.
Relay output module	OPCRLY	404849

**Analog I/O module**

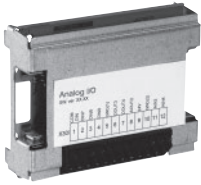

Analog I/O internal drive mounted module for use on AF-600 FP drive only. Module includes: 3 Analogue inputs 0-10V, 0/4-20mA  
3 Analogue outputs 0-10V  
Battery back-up power for AF-600 FP's internal real time clock

Analog I/O module	OPCAIO	404816
-------------------	--------	--------

**24V DC external supply module**



24V DC external supply internal drive mounted module for use on AF-600 FP drives. This module accepts an external 24V DC supply which is used to keep the control board of the drive and other option modules powered in the event of a line side power outage. Can be used with communications and I/O modules.

24V DC external supply module	OPC24VPS	404815
-------------------------------	----------	--------

**General purpose I/O module**



General purpose I/O internal drive mounted module for use on AF-600 FP drives. Module includes: 3x digital inputs 24V  
2x digital outputs PNP/NPN  
2x analogue inputs 0-10V  
1x analogue output 0/4-20mA

General purpose I/O module	OPCGPIO	404821
----------------------------	---------	--------

**Screw terminal accessory**



Screw terminal accessory is available for field installation on AF-600 FP drives. These screw terminals can replace the cage clamp terminals which ship with each drive. This set of three terminals are for the digital inputs, analog I/O, and RS485 connection.

Screw terminal accessory	OPCSTERM	404822
--------------------------	----------	--------

Options and accessories (continued)

**Pedestal kit**

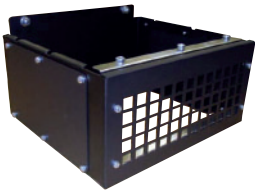

Pedestal kit allows Unit Size 41h and 42h drives to be floor mounted (IP21/54/55, 110 to 250/315kW at 400V for AF-600 FP).

Description	Cat. No.	Ref. No.
Pedestal kit for unit size 41h	OPCPED41H	409506
Pedestal kit for unit size 42h	OPCPED42H	409507

**USB kit**



This kit allows for the USB programming terminal to be brought out to the front cover of the drive. Works with all drive types.

Description	Cat. No.	Ref. No.
For all drives up to unit size 5X	OPCUSB	404861
For all unit size 6X drives	OPCUSB6X	404860

**Power shields**

These shields are used to cover the drive power terminals on IP21 and IP54/55 drive types.

For unit size 51 drives	OPCCOVER51	404847
-------------------------	------------	--------

## Basic wiring diagrams

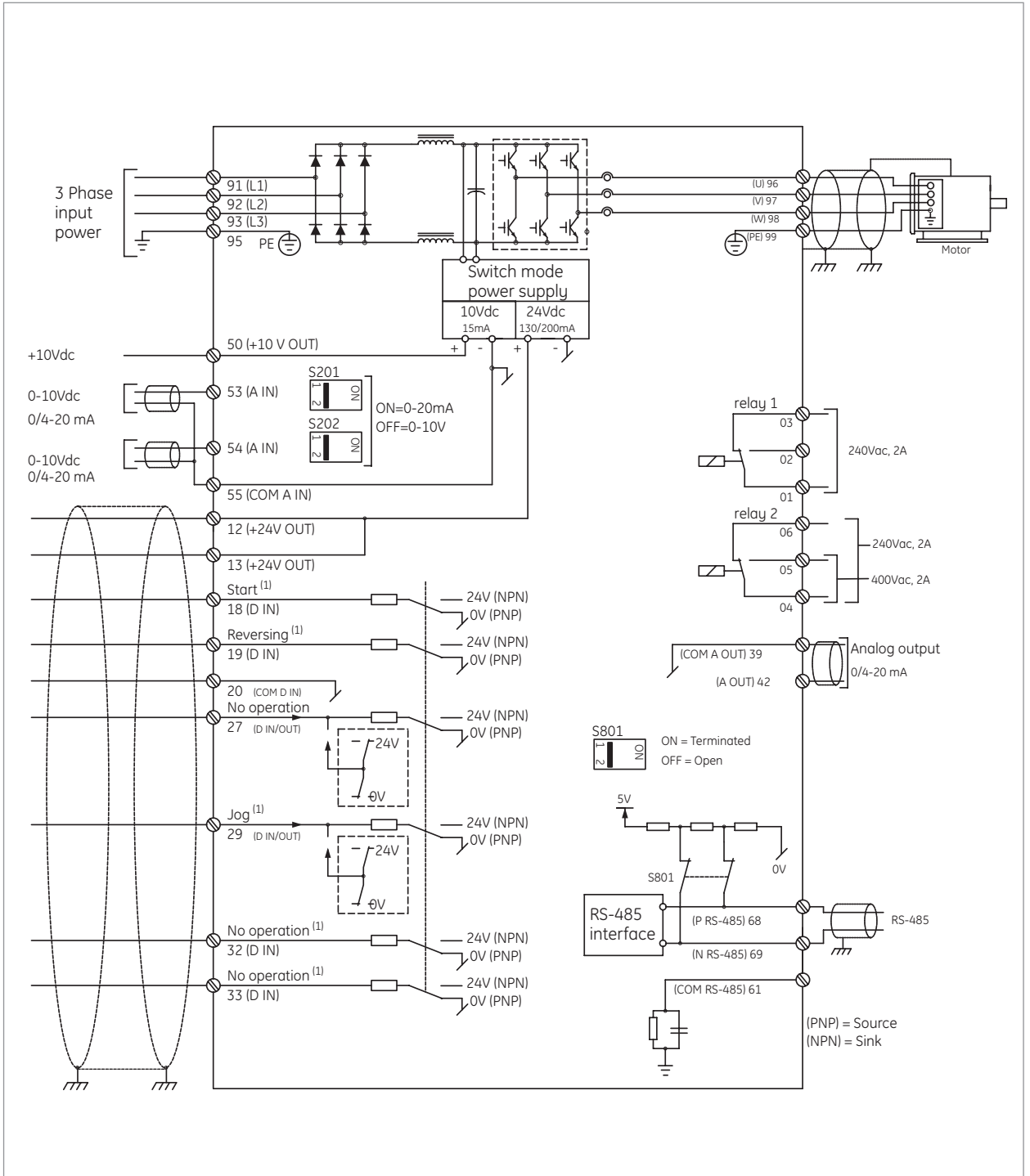

(1) Indicates default setting; see parameter group E-## to re-program.



## Specifications

### Environmental conditions

Enclosures	IP20 chassis, IP00 chassis, IP21, IP55, IP54
Installation location	For use at altitudes of 1000 m or less without derating.
Storage temperature	-25° to 65°C
Ambient temperature	-10° to +50°C for above 45°C, there will be derating; please consult GE
Ambient humidity	5 to 95% RH (non-condensing)
Vibration	1.0 G
Cooling method	Fan cooled all ratings. Fan control auto, 50% level, 75% level, 100% level adjustable

### Standards

Approvals	CE, UL, cUL, and C-Tick Suitable for use on a circuit capable of delivering not more than 100,000 rms symmetrical amperes for 230V and 400V.
-----------	---

### Input power supply

Rated input AC voltage	200-240 Vac, 3-phase, 50-60 Hz, +/- 10% V 380-480 Vac, 3-phase, 50-60 Hz, +/- 10% V 525-690 Vac, 3-phase, 50-60 Hz, +/- 10% V
Maximum voltage imbalance	3% of rated supply voltage
True power factor	> 0.9 nominal at rated load
Displacement power factor	> 0.98
Switching on input power supply	Maximum twice/minute up to 7.5kW, maximum once/minute above 7.5kW
Environment according to EN60664-1	Overvoltage category III/pollution degree 2
DC link reactors	Built-In DC Link Reactors on all ratings
RFI filters	Built-In RFI Filters to reduce noise generated by the drive.

### Output

Rated output voltage	0-100% of supply voltage
Output frequency	0-590 Hz
Switching on output	Unlimited
Accel/decel times	1-3600 seconds
Control method	Sinusoidal PWM control (V/Hz, Avd. vector control)

### Control

Starting torque	110% starting torque for 1 minute (variable torque)
Carrier frequency (motor noise)	Selectable - 1, 1.5, 2, 2.5, 3, 3.5, 4, 5, 6, 7, 8, 10, 12, 14, 16 kHz
Torque boost	0 - 300% setting to compensate voltage in relation to the load at low speed
Acceleration/deceleration time	0.01-3600 seconds (4 acceleration and deceleration times are selectable via digital inputs. Acceleration and deceleration patterns can be selected from linear or S-curve)
Data protection	Password protection for quick menu or main menu, 0-9999.
Pattern operation	Settings via built-in logic controller sequencer
Jump frequency control	4 jump (or skip) frequencies via parameter set to avoid mechanical vibration
Slip compensation	Maintains motor at constant speed with load fluctuations
Torque limit control	Output torque can be controlled within a range of 0.0 to 110% (0.1 and steps)
Preset speeds	8 programmable preset speeds selectable by 3 digital inputs
Built-in communications	Drive RS-485, Modbus RTU, Metasys N2, or Apogee FLN P1
Trim reference setting	Available for speed reference offset via potentiometer, voltage input, or current input
DC injection braking	Starting frequency: 0.0-590 Hz, Braking time: 0.0-60.0 seconds, Braking level: 0-100% of rated current
Jogging operation	Operation via on key or digital input (fwd or rev)

Auto-restart after power failure	Restarts the drive without stopping after instantaneous power failure
Energy savings	Controls output voltage to minimize motor loss during constant speed operation
Start mode function	This functionality smoothly catches a spinning motor
Fire override mode	Overrides drive's protective features and keeps motor running
Pump cascade controller	Distributes running hours evenly over up to 4 pumps
Sleep mode	Drive detects low or no flow conditions and adjusts output
Dry pump detection	Detects pump operation and can set off alarm, shuts off, or other programmed actions
Belt monitoring	Drive can detect relationship between current and speed to recognize a broken belt
Real time clock	With programmable timed actions

### Logic controller (LC) sequencer

Logic controller events	Up to 38 programmable events
Comparators	Array of 6 comparators
Timers	Array of 8 timers, adjustable from 0.0 to 3600 sec
Logic rules	Array of 6 boolean logic rules
Logic controller states	Array of 20 logic controller action states

### Process controller (PID)

Controller	4 auto tune PID controllers built-in
Feedback select	Up to 2 references. Selectable - no function, motor feedback, separate encoder, encoder option module, or resolver option module
Control	Normal or inverse
Anti windup	Disabled or enabled
Start speed	0.0-200Hz
Proportional gain	0.00-10.00
Integral time	0.1 - 10000.0 ms
Differential time	0.0 - 10 s
Differential gain	1.0-50.00
Feed forward factor	0-500%
On reference bandwidth	0-200%

### Operation

Operation method	Keypad operation: hand, off, auto digital input: programmable for start/stop, forward/reverse, jog timer operation: stop after predetermined time frame Communications: RS-485 Modbus RTU, Metasys N2, and Apogee FLN P1 USB port for programming drive with optional PC software
Frequency reference signal	Left or right arrow buttons on keypad in manual mode Speed potentiometer: 0 to +10Vdc, 10 to 0Vdc 0-10Vdc analog input 0/4-20ma analog input
References	Up to 3 Input references can be selected from analogue input #1 or #2, frequency input #1 or #2, network, or potentiometer
Output signals	2x digital outputs 24 Vdc (digital outputs are used in place of 2 of the digital inputs) 2x form C relays rated to 2A at 230 Vac 1x analog output 0/4 to 20mA



## Specifications

<b>Protective functions</b>	<ul style="list-style-type: none"> <li>Line phase loss</li> <li>DC overvoltage</li> <li>DC undervoltage</li> <li>Drive overload</li> <li>Motor overtemperature</li> <li>Motor thermistor overtemperature</li> <li>Torque limit</li> <li>Overcurrent</li> <li>Ground fault</li> <li>Short circuit</li> <li>Control word timeout</li> <li>Brake resistor short-circuited</li> <li>Brake chopper short-circuited</li> <li>Brake check</li> <li>DC Link voltage high</li> <li>DC Link voltage low</li> <li>Internal fan fault</li> <li>External fan fault</li> <li>Power board overtemperature</li> <li>Missing U phase</li> <li>Missing V phase</li> <li>Missing W phase</li> <li>Internal fault</li> <li>Control voltage fault</li> <li>Auto tune check - wrong motor parameters</li> <li>Auto Tune low inom - motor current is too low</li> <li>Current limit</li> <li>Mechanical brake low</li> <li>Drive initialized to default value</li> <li>Keypad error</li> <li>No motor</li> <li>Soft charge fault</li> <li>Auto tuning fault</li> <li>Serial comms bus fault</li> <li>Hardware mismatch</li> <li>Speed limit</li> </ul>
-----------------------------	---

### Keypad

<b>Keypad features</b>	<ul style="list-style-type: none"> <li>LCD display with 6 alpha-numeric lines.</li> <li>Multi-language support</li> <li>Hot pluggable, remote mount option, and copy-cat Feature, IP65 rating when remote mounted on enclosure</li> <li>LED's - green - drive is on, yellow - indicates a warning, red - indicates an alarm, amber - indicates active menu keys and H-O-A keys</li> </ul>
<b>Password</b>	2 level password protection
<b>Alternate motor parameters</b>	Up to 4 separate complete parameter set-ups are available
<b>Graphical trending</b>	Trend speed, power, frequency

### RS485 Modbus RTU serial communications

<b>Physical level</b>	EIA/RS485
<b>Transmission distance</b>	500m
<b>Node address</b>	32
<b>Transmission speed</b>	2400, 4800, 9600, 19200, 38400, or 115200 (bits/s)
<b>Transmission mode</b>	Half Duplex
<b>Transmission protocol</b>	Modbus RTU
<b>Character code</b>	Binary
<b>Character length</b>	8 bits
<b>Error check</b>	CRC

### Mounting clearance

All AF-600 FP drives can be mounted side-by-side without spacing. For all drives rated 90kW or below allow 100mm free space above and below.  
For all drives rated 110kW and above allow 225mm free space above and below.



Efficiency, Watt loss, unit size, dimensions and weights

230 Vac, 3-phase, 50/60Hz

Nominal motor ratings		Efficiency			Watt loss (W)	Unit size	Drive type	Height (mm)	Width (mm)	Depth (mm)	Weight (kg)
Power kW	Current A	at 5 kHz (%)	at 4 kHz (%)	at 3 kHz (%)							
0.75	6.6	96			63	12	IP20	375	90	220	5
1.5	7.5	96			82	12		375	90	220	5
2.2	10.6	96			116	12		375	90	220	5
4	16.7	96			185	13		375	90	220	5
5.5	24.2		96		269	23		375	130	220	7
7.5	30.8		96		310	23		375	130	220	7
11	46.2		96		447	23		420	165	262	12
15	59.4		96		602	24		420	165	262	12
18.5	74.8		96		737	24		595	230	242	24
22	88			97	845	33		595	230	242	24
30	115			97	1140	33		595	230	242	24
37	143			97	1353	34		630	308	334	35
45	170			97	1636	34		630	308	334	35

400 Vac, 3-phase, 50/60Hz

Nominal motor ratings		Efficiency				Watt loss (W)	Unit size	Drive type	Height (mm)	Width (mm)	Depth (mm)	Weight (kg)
Power kW	Current A	at 5 kHz (%)	at 4 kHz (%)	at 3 kHz (%)	at 2 kHz (%)							
0.75	2.4	96				58	12	IP20	375	90	220	5
1.5	4.1	97				62	12		375	90	220	5
2.2	5.6	97				88	12		375	90	220	5
4	10	97				124	12		375	90	220	5
5.5	13	97				187	13		375	90	220	5
7.5	16	97				255	13		375	130	220	7
11	24		98			278	23		375	130	220	7
15	32		98			392	23		420	165	262	12
18.5	37.5		98			465	23		420	165	262	12
22	44		98			525	24		595	230	242	24
30	61		98			698	24		595	230	242	24
37	73		98			739	24		595	230	242	24
45	90			98		843	33		630	308	334	35
55	106			98		1083	33		630	308	334	35
75	147			98		1384	34		800	370	334	50
90	177			99		1474	34		800	370	334	50
110	212			98		2559	43h		909	250	35	62
132	260			98		2954	43h		909	250	35	62
160	315			98		3770	43h		909	250	35	62
200	395			98		4116	44h		1122	350	375	125
250	480			98		5137	44h	1122	350	375	125	
315	600				98	6674	44h	1122	350	375	125	
355	658			98		7532	52	1547	585	497.8	313	
400	745			98		8677	52	1547	585	497.8	313	
450	800			98		9428	52	1547	585	497.8	313	
500	80			98		10162	61	2282	1400	606	1004	
560	990			98		11822	61	2282	1400	606	1004	
630	1120			98		12512	61	2282	1400	606	1004	
710	1260			98		14674	61	2282	1400	606	1004	
800	1460			98		17293	62	2282	1800	606	1262	
1000	1720			98		19278	62	2282	1800	606	1262	



## Dimensional drawings

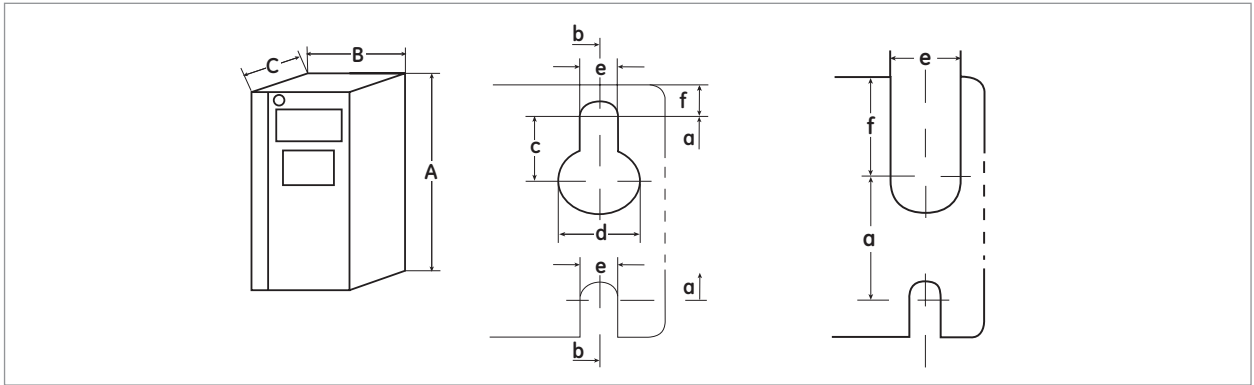

### Dimensions, 1X unit sizes (mm)

Unit size		Dimensions	12	13	15
<b>Enclosure type</b>			IP20	IP20	IP55
<b>Voltage</b>	230V		0.75 to 2.2kW 1 to 3HP	3.7kW 5HP	0.75 to 3.7kW 1 to 5HP
	400V		0.75 to 2.2kW 1 to 5HP	5.5 to 7.5kW 7.5 to 10HP	0.75 to 7.5kW 1 to 10HP
<b>Height</b>	Height of backplate	<b>A</b>	268	268	420
	Height with de-coupling plate	<b>A</b>	375	375	
	Distance between mounting holes	<b>a</b>	257	257	402
<b>Width</b>	Width of backplate	<b>B</b>	90	130	242
	Distance between mounting holes	<b>b</b>	70	110	215
<b>Depth</b>	Depth without I/O and/or network option	<b>C</b>	205	205	195
	Depth with I/O and/or network option	<b>C</b>	220	220	195
<b>Screw holes</b>		<b>c</b>	8,0	8,0	8,3
		<b>d</b>	11,0	11,0	12,0
		<b>e</b>	5,5	5,5	6,5
		<b>f</b>	9,0	9,0	9,0
<b>Weight (kg)</b>			4,9	6,6	13,5 / 14,2

### Dimensions, 2X unit sizes (mm)

Unit size		Dimensions	21 <sup>(1)</sup>	22 <sup>(1)</sup>	23	24
<b>Enclosure type</b>			IP55	IP55	IP20	IP20
<b>Voltage</b>	230V		5.5 to 11kW 7.5 to 15HP	15kW 20HP	5.5 to 11kW 7.5 to 15HP	15 to 18.5kW 20 to 25HP
	400V		11 to 15kW 15 to 25HP	22 to 30kW 30 to 40HP	11 to 18.5kW 15 to 25HP	22 to 37kW 30 to 50HP
<b>Height</b>	Height of backplate	<b>A</b>	480	650	399	521
	Height with de-coupling plate	<b>A</b>	-	-	420	595
	Distance between mounting holes	<b>a</b>	455	625	380	495
<b>Width</b>	Width of backplate	<b>B</b>	242	242	165	230
	Distance between mounting holes	<b>b</b>	210	210	140	200
<b>Depth</b>	Depth without I/O and/or network option	<b>C</b>	260	260	249	242
	Depth with I/O and/or network option	<b>C</b>	260	260	262	242
<b>Screw holes</b>		<b>c</b>	12,0	12,0	8,0	-
		<b>d</b>	19,0	19,0	12,0	-
		<b>e</b>	9,0	9,0	6,8	8,5
		<b>f</b>	9,0	9,0	7,9	15,0
<b>Weight (kg)</b>			23,0	27,0	12,0	23,5

(1) IP55/IP66 units need to have cable glands according table on page 28 (Cable entry overview)



## Dimensional drawings

### Dimensions, 3X unit sizes (mm)

Unit size		Dimensions	31 <sup>(2)</sup>	32 <sup>(2)</sup>	33	34
<b>Enclosure type</b>			IP55	IP55	IP20	IP20
<b>Voltage</b>	230V		18.5 to 30kW 25 to 40HP	37 to 45kW 50 to 60HP	Open chassis 22 to 30kW 30 to 40HP	Open chassis 37 to 45kW 50 to 60HP
	400V		37 to 55kW 50 to 75HP	75 to 90kW 100 to 125HP	45 to 55kW 60 to 75HP	75 to 90kW 100 to 125HP
<b>Height</b>	Height of backplate	<b>A</b>	680	770	550	660
	Height with de-coupling plate	<b>A</b>	-	-	630	800
	Distance between mounting holes	<b>a</b>	648	739	521	631
<b>Width</b>	Width of backplate	<b>B</b>	308	370	308	370
	Distance between mounting holes	<b>b</b>	272	334	270	330
<b>Depth</b>	Depth without I/O and/or network option	<b>C</b>	310	335	333	333
	Depth with I/O and/or network option	<b>C</b>	310	335	333	333
<b>Screw holes</b>		<b>c</b>	12.5	12.5	-	-
		<b>d</b>	19.0	19.0	-	-
		<b>e</b>	9.0	9.0	8.5	8.5
		<b>f</b>	9.8	9.8	17.0	17.0
<b>Weight (kg)</b>			45	65	35	50

### Dimensions IP20 open chassis drives with field installed IP21 kits<sup>(1)</sup> (mm)

Unit size		12	13	23	24	33	34
<b>Enclosure type</b>		IP20 open chassis with IP21 Kit					
<b>Voltage</b>	230V	0.75 to 2.2kW 1 to 3HP	3.7kW 5HP	5.5 to 11kW 7.5 to 15HP	15 to 18.5kW 20 to 25HP	22 to 30kW 30 to 40HP	37 to 45kW 50 to 60HP
	400V	0.75 to 2.2kW 1 to 5HP	5.5 to 7.5kW 7.5 to 10HP	11 to 18.5kW 15 to 25HP	22 to 37kW 30 to 50HP	45 to 55kW 60 to 75HP	75 to 90kW 100 to 125HP
<b>Height</b>	Height with kit	375	375	475	671	754	950
<b>Width</b>	Width of backplate	94	130	165	231	397	371
	Distance between mounting holes	70	110	140	201	269	330
<b>Depth</b>	Depth without I/O and/or network option	205	205	249	242	338	338
	Depth with I/O and/or network option	220	220	262	242	338	338

(1) Please consult IP21 kit instructions for further mounting details and dimensions.

(2) IP55/IP66 units need to have cable glands according table on page 28 (Cable entry overview)

Note: Please allow 5cm between drives with field installed IP21 kits. Also, please consult the relevant AF-6 Series drives operating Instructions for recommended clearance above and below each drive rating.



## Dimensional drawings in mm (inches)

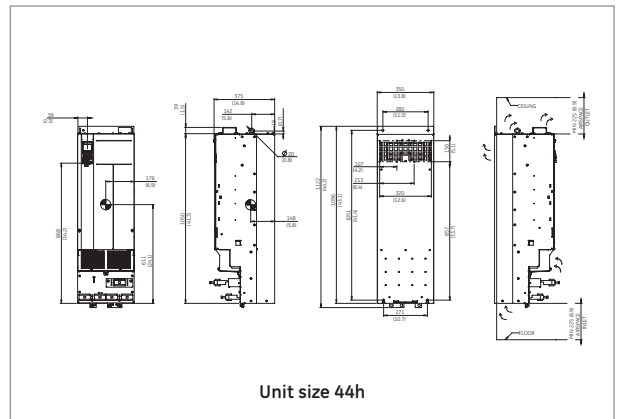
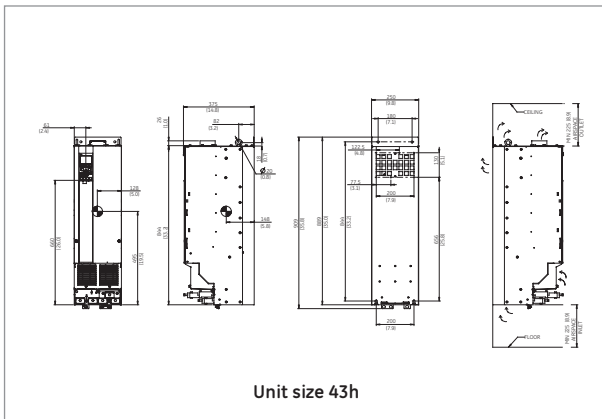
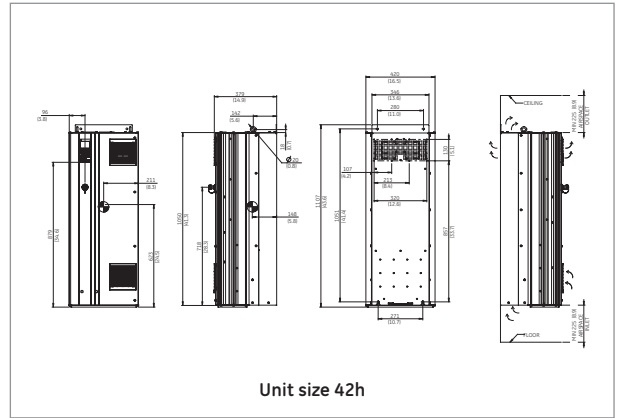
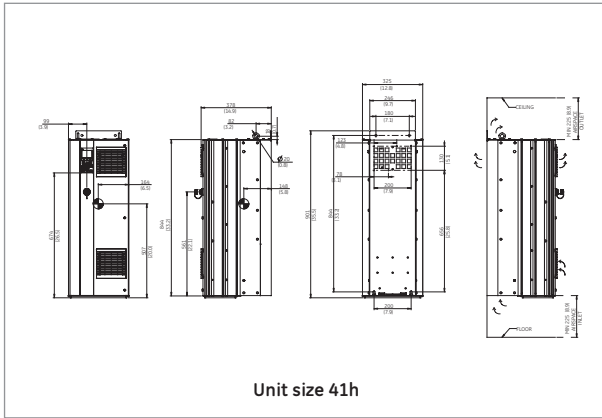

Unit size		41h	42h	43h	44h
Enclosure type		IP21/IP54	IP21/IP54	IP20	IP20
Voltage	400V	110 to 160kW 150 to 250HP	200 to 315kW 300 to 450HP	110 to 160kW 125 to 250HP	200 to 315kW 300 to 450HP
	690V	90 to 132kW 125 to 200HP	160 to 315kW 250 to 450HP	90 to 132kW 125 to 200HP	160 to 315kW 250 to 450HP
Shipping dimensions	Height	590	590	590	590
	Width	1000	1170	1000	1170
	Depth	460	535	460	535
Drive dimensions	Height	901	1107	909	1122
	Width	325	420	250	350
	Depth	378	379	375	375
Weight (kg)		98	164	98	164



## Dimensional drawings in mm (inches)

Unit size 62

**Unit size 62**

Enclosure type	IP21/IP55
Voltage	400V
	800 to 1000kW 1200 to 1350HP
<b>Shipping dimensions</b>	
Height	2324
Width	1961
Depth	419
<b>Drive dimensions</b>	
Height	2282
Width	1800
Depth	606
Weight (kg)	1262

Unit size 63

**Unit size 63**

Enclosure type	IP21/IP55
Voltage	400V
	500 to 710kW 650 to 1000HP
<b>Shipping Dimensions</b>	
Height	2324
Width	2159
Depth	927
<b>Drive Dimensions</b>	
Height	2282
Width	2000
Depth	606
Weight (kg)	1300

Unit size 64

**Unit size 64**

Enclosure type	IP21/IP55
Voltage	400V
	800 to 1000kW 1200 to 1350HP
<b>Shipping dimensions</b>	
Height	2324
Width	2543
Depth	927
<b>Drive dimensions</b>	
Height	2282
Width	2400
Depth	606
Weight (kg)	1541

## Common accessories

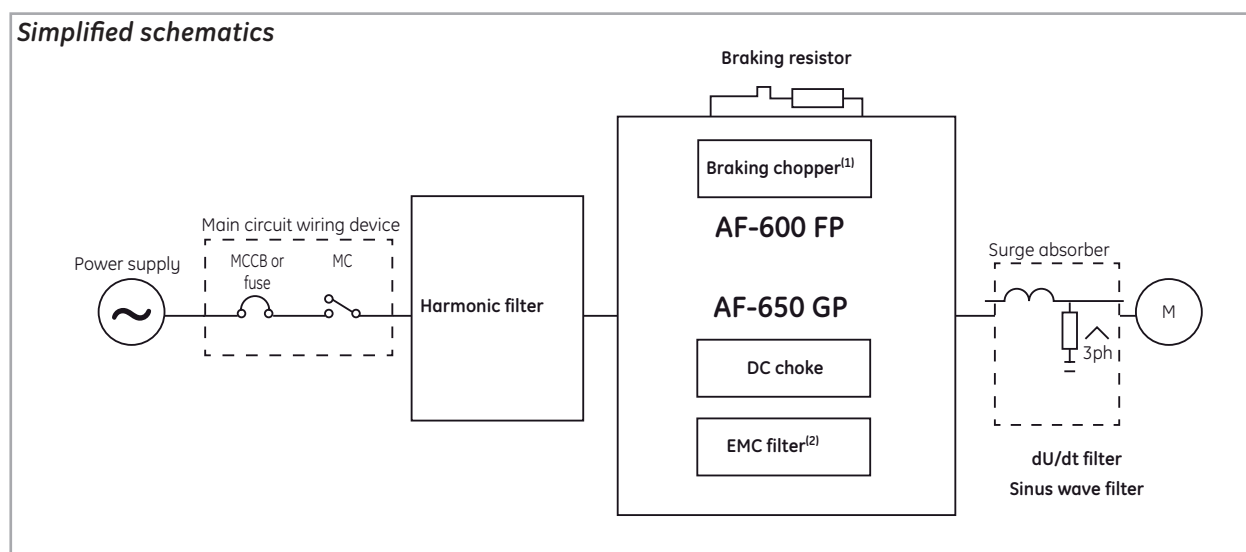

(1) If a braking chopper is required, it has to be requested during the order. It is not an external option (only available for AF-650 GP).  
 (2) EMC filter are built inside all drives. It is not an external option.

### Harmonic filter

- Available from 10 to 613A at 380 – 415V 50Hz and from 43 to 370A at 690V
- Comply with IEEE 519-1992 and stage 1 of EN 61000-3-12
- Specially designed for unmatched harmonic performance.
- Small foot print and high harmonic reduction

The harmonic current distortion generated back to the mains is reduced to 5 and 10% total harmonic current distortion at full load. With an efficiency higher than 98%, those passive filter are compact and very robust harmonic solution specifically for power up to 400kW.

#### Reliable

Fully tested and based on proven filter concept... low failure rate

#### Savings

High efficiency... low running expenses

#### Design

Side-by-side mounting... less space needed

Easy commissioning... reduce costs

### Specifications

Mains voltage	±10%
Frequency	±5%
Overload current	160% for 60s
Ambient temperature	5° to 40°C without derating

## What accessory for the drive output?

### Specifications

Performance criteria	dU/dt filter	Sine-wave filter
<b>Motor insulation stress</b>	Up to 100m cable (shielded/unshielded) complies with the requirements of IEC60034-17*. Above this length, the risk of double pulsing increases.	Provides a sinusoidal phase-to-phase motor terminal voltage. Complies with the requirements of IEC60034-17* with cables up to 500m (1km for frame size 4x and above)
<b>Motor bearing stress</b>	Slightly reduced, mainly in high power motors.	Reduces bearing currents caused by circulating currents. Does not reduce common-mode currents (shaft currents).
<b>EMC performance</b>	Eliminates motor cable ringing. Does not change the emission class. Does not allow longer motor cable as specified for the speed drive's built-in RFI filter.	
<b>Max. motor cable length</b>	100 - 150m With guaranteed EMC performance: 150m shielded Without guaranteed EMC performance: 150m unshielded	With guaranteed EMC performance: 150m shielded and 300m unshielded (only conducted emissions) Without guaranteed EMC performance: up to 500m (1km for frame size 4x and above)
<b>Acoustic motor switching noise</b>	Does not eliminate acoustic switching noise from the motor.	Eliminate acoustic switching noise from the motor caused by magnetostriction.
<b>Size</b>	15 - 50% (depending on power size)	100%
<b>Price</b>	50%	100%

### dU/dt filter

dU/dt filters reduce the dU/dt values on the motor terminal phase-to-phase voltage – an issue that is important for short motor cables. Available from 27 to 880A

Perfect match for applications with older motors, with frequent braking and for short motor cable length (up to 150m) dU/dt filters are differential-mode filters which reduce motor terminal phase-to-phase peak voltages spikes and reduce the rise time to a level that lowers the stress on the insulation of motor windings. They have a cut-off frequency above the switching frequency. The voltage at the motor is still PWM pulse shaped but the rise time and U<sub>peak</sub> are reduced. Since they have smaller inductance and capacitance, the dU/dt filters introduce a negligible reactance between the speed drive and the motor, therefore suitable for high dynamic applications.

Output chokes cause undamped oscillations at the motor terminals which increase the risk of double pulsing and overvoltages higher than twice the DC link voltage. The dU/dt filters are low-pass L-C filters with a well defined cut-off frequency, therefore, the ringing oscillations are damped and there is a reduced risk of double pulsing and voltage peaks.

**Benefits**

- Reduces dU/dt stresses... increase motor service interventions
- Ideal for highly dynamic applications with flux vector regulation... smaller and less expensive than sine-wave filters
- Side-by-side mounting... less space needed

### Specifications

Mains voltage	3 x 200 - 690V
Frequency	0-60Hz without derating Max 100Hz (with derating)
Overload current	160% for 60s, every 10 minutes
Minimum/Maximum switching frequency	fmin = 1.5 to 5kHz (depending on filter type) fmax = 8kHz
Ambient temperature	-25° to 45°C without derating

### Sine-wave filter

Sine-wave output filters are low-pass filters that suppress the switching frequency from the drive and smooth out the phase-to-phase output voltage to become sinusoidal. This reduces the motor insulation stress and bearing currents.

Available from 2.5 to 800A.

Perfect match for applications with older motors, with frequent braking, for 690V applications and for motor cable length above 150m.

**Benefits**

- The switching acoustic noise from the motor is eliminated.
- Reduces hysteresis thermal losses in the motor... prolongs the lifetime of the motor.
- Suppress any bearing currents in the motor... reduces risk of flashover in the motor bearings and also contributes to extend motor lifetime and increase service intervals.

### Specifications

Mains voltage	3 x 200 - 690V
Frequency	0-60Hz without derating
Overload current	160% for 60s, every 10 minutes
Minimum/Maximum switching frequency	fmin = 1.5 to 5kHz (depending on filter type) fmax = 8kHz
Ambient temperature	-25° to 45°C without derating



## Dynamic Braking Resistors

Dynamic braking allows for faster deceleration rates than could be achieved via a coast to stop. Dynamic braking consists of the internal drive brake chopper and separate add-on dynamic braking resistors.

Important application notes:

- The AF-60 LP Micro Drive dynamic braking can be used for stopping a load with an inertia equal to or less than the applied motor's rotor inertia.
- High inertia or overhauling loads may cause extended deceleration times which could cause overheating and tripping of the drive.
- The dynamic braking is not a holding brake. It does not prevent a motor at rest from rotating.

Note: refer to the drives' Operating Instruction for installation and connection details.

### Dynamic braking resistors- AF-60 LP drives

#### 230 Vac

Nominal applied motor kW	Nominal applied motor HP	Max. braking torque (%)	Brake chopper	Recommended dynamic braking resistor				Total Ohms	Total kW	
				10% duty cycle		40% duty cycle			10% duty cycle	40% duty cycle
				Cat. No.	Ref. No.	Cat. No.	Ref. No.			
0.18	1/4	-	N/A	-	-	-	-	-	-	
0.37	1/2	-	N/A	-	-	-	-	-	-	
0.75	1	-	N/A	-	-	-	-	-	-	
1.5	2	150	Built-in	TLR74P200	129870	4 x TLR74P200	4 x 129870	74	0.2	0.8
2.2	3	150	Built-in	TLR44P600	129166	TLR43P1000	129177	44	0.6	1
3.7	5	150	Built-in	TLR29P600	129167	TLR22P2500	129879	29	0.6	2.5

#### 400 Vac

Nominal applied motor kW	Nominal applied motor HP	Max. braking torque (%)	Brake chopper	Recommended dynamic braking resistor				Total Ohms	Total kW	
				10% duty cycle		40% duty cycle			10% duty cycle	40% duty cycle
				Cat. No.	Ref. No.	Cat. No.	Ref. No.			
0.37	1/2	-	N/A	-	-	-	-	-	-	
0.75	1	-	N/A	-	-	-	-	-	-	
1.5	2	150	Built-in	TLR295P200	129876	4 x TLR295P200	4 x 129876	295	0.2	0.8
2.2	3	150	Built-in	TLR216P200	129868	4 x TLR216P200	4 x 129868	216	0.2	0.8
4	5	150	Built-in	TLR118P600	129174	4 x TLR118P600	4 x 129174	118	0.6	2.4
5.5	8	150	Built-in	TLR86P600	129175	4 x TLR86P600	4 x 129175	86	0.6	2.4
7.5	10	150	Built-in	TLR59P1000	129176	4 x TLR59P1000	4 x 129176	59	1	4
11	15	150	Built-in	TLR43P1000	129177			43	1	-
15	20	150	Built-in	TLR35P1500	129877			35	1.5	-
18.5	25	150	Built-in	TLR29P1800	129878	On request		29	1.8	-
22	30	150	Built-in	TLR22P2500	129879			22	2.5	-

## Dynamic braking resistors - AF-650 GP drives

### 230 Vac

Nominal applied motor kW	Nominal applied motor HP	Max. braking torque (%)	Repetitive braking torque duty - 10%					Repetitive braking torque duty - 40%				
			(kW)	Ohms	Cont. max breaking time(s)	Cat. No.	Ref. No.	(kW)	Ohms	Cont. max breaking time(s)	Cat. No.	Ref. No.
0.25	1/3	160	0.2	405	12	TLR405P200	129867	0.43	425	120	TLR405P200	129867
0.37	1/2	160	0.2	295	12	TLR295P200	129876	0.80	310	120	4 x TLR295P200	4 x 129876
0.75	1	160	0.6	118	12	TLR118P600	129174	0.26	145	120	TLR118P600	129174
1.5	2	160	1	59	12	TLR59P1000	129176	0.80	65	120	TLR59P1000	129176
2.2	3	160	1	43	12	TLR43P1000	129177	1.00	50	120	TLR43P1000	129177
3.7	5	160	1.8	29	12	TLR29P1800	129878	3.00	25	120	TLR22P2500	129879
5.5	7.5	158	2.5	22	12	TLR22P2500	129879	-	-	-	-	-
7.5	10	153	3	17.6	12	2 x TLR8,8P1500	2 x 129171	-	-	-	-	-
11	15	154	5	10	12	2 x TLR5P2500	2 x 129871	-	-	-	-	-
15	20	150	6	8	12	2 x TLR4P3000	2 x 129872	-	-	-	-	-
18.5	25	150	6	8	12	2 x TLR4P3000	2 x 129872	-	-	-	-	-
22	30	150	6	4.7	30			-	-	-	-	-
30	40	150	8	3.3	30			-	-	-	-	-
37	50	150	10	2.7	30		On request	-	-	-	-	-

### 400 Vac

Nominal applied motor kW	Nominal applied motor HP	Max. braking torque (%)	Repetitive braking torque duty - 10%					Repetitive braking torque duty - 40%				
			(kW)	Ohms	Cont. max breaking time(s)	Cat. No.	Ref. No.	(kW)	Ohms	Cont. max breaking time(s)	Cat. No.	Ref. No.
0.37	0.5	160	0.2	750	12	TLR750P200	116301	0.2	620	120	TLR750P200	116301
0.75	1	160	0.2	750	12	TLR750P200	116301	0.2	620	120	TLR750P200	116301
1.5	2	160	0.2	295	12	TLR295P200	129876	0.4	310	120	2 x TLR750P200	2 x 116301
2.2	3	160	0.2	216	12	TLR216P200	129868	0.4	210	120	2 x TLR432P200	2 x 129875
4	5	160	0.6	118	12	TLR118P600	129174	2	110	120	2 x TLR59P1000	2 x 129176
5.5	7.5	160	0.6	86	12	TLR86P600	129175	3	80	120	2 x TLR35P1500	2 x 129877
7.5	10	160	1	59	12	TLR59P1000	129176	6	65	120	2 x TLR35P3000	2 x 129888
11	15	160	1	43	12	TLR43P1000	129177	5	40	120	2 x TLR22P2500	2 x 129879
15	20	160	1.5	35	12	TLR35P1500	129877	7.4	30	120	2 x TLR15P3700	2 x 129881
18.5	25	160	1.8	29	12	TLR29P1800	129878	10	25	120	4 x TLR22P2500	4 x 129879
22	30	160	2.5	22	12	TLR22P2500	129879	10	20	120	4 x TLR22P2500	4 x 129879
30	40	150	3.7	15	12	TLR15P3700	129881	14.8	15	120	4 x TLR15P3700	4 x 129881
37	50	150	4.7	12.5	12							
45	60	150	6.4	9.2	12							
55	75	150	7.7	4.3	12							
75	100	150	13.6	4.3	12							
90	125	150	17	3.4	30							
110	150	150	17	3.4	30							
132	200	150	22.5	10.4	30							
160	250	150	27.2	8.6	30							
200	300	150	17	3.3	30							
250	350	150	22.4	10.4	30							
355	450	150	27.2	8.6	30							
400	550	150	14.4	1.3	30							
450	600	150	14.4	1.3	30							
500	650	150	14.4	1.3	30							
560	750	150	14.4	1.3	30							
630	900	150	14.4	1.3	30							
710	1000	150	14.4	1.3	30							
800	1200	150	14.4	1.3	30							





Notes

A large grid of dotted lines for taking notes, consisting of approximately 30 columns and 40 rows of small dots.



By reference number

Ref. nr.	Art.	Pag.	Ref. nr.	Art.	Pag.	Ref. nr.	Art.	Pag.	Ref. nr.	Art.	Pag.
116000			402941	6KGP43010X9RXXA1	16	403167	6KGP43040X2XBXA1	17	403562	6KGP63550X8XXCA1	15
116301	TLR750P200	54	402942	6KGP43015X9RXXA1	16	403168	6KGP43050X2XBXA1	17	403563	6KGP63650X8XXCA1	15
129000			402943	6KGP43020X9RXXA1	16	403169	6KGP43060X2XBXA1	17	403564	6KGP63750X8XXCA1	15
129166	TLR44P600	53	402944	6KGP43025X9RXXA1	16	403170	6KGP43075X2XBXA1	17	403565	6KGP63900X1XXCA1	15
129167	TLR29P600	53	402945	6KGP43030X9RXXA1	16	403171	6KGP43100X2XBXA1	17	403566	6KGP631K0X1XXCA1	15
129171	TLR8,8P1500	54	402946	6KGP43040X9RXXA1	16	403178	6KGP43450X2XBXA1	17	403567	6KGP631K1X1XXCA1	15
129174	TLR118P600	53	402947	6KGP43050X9RXXA1	16	403179	6KGP43500X2XBXA1	17	403568	6KGP631K2X1XXCA1	15
129175	TLR86P600	53	402948	6KGP43060X9RXXA1	16	403180	6KGP43550X2XBXA1	17	403569	6KGP631K3X1XXCA1	15
129176	TLR59P1000	53	402949	6KGP43075X9RXXA1	16	403181	6KGP43600X2XBXA1	17	403597	6KGP63500X2XXCA1	17
129177	TLR43P1000	53	402950	6KGP43100X9RXXA1	16	403182	6KGP43650X2XBXA1	17	403598	6KGP63550X2XXCA1	17
129867	TLR405P200	54	402957	6KGP43450X8RXXA1	16	403183	6KGP43750X2XBXA1	17	403599	6KGP63650X2XXCA1	17
129868	TLR216P200	53	402958	6KGP43500X8RXXA1	16	403184	6KGP43900X2XBXA1	17	403600	6KGP63750X2XXCA1	17
129870	TLR74P200	53	402959	6KGP43550X8RXXA1	16	403185	6KGP431K0X2XBXA1	17	403601	6KGP63900X2XXCA1	17
129871	TLR5P2500	54	402960	6KGP43600X1RXXA1	16	403186	6KGP431K2X2XBXA1	17	403602	6KGP631K0X2XXCA1	17
129872	TLR4P3000	54	402961	6KGP43650X1RXXA1	16	403187	6KGP43F50X4XBXA1	19	403603	6KGP631K1X2XXCA1	17
129875	TLR432P200	54	402962	6KGP43750X1RXXA1	16	403188	6KGP43001X4XBXA1	19	403604	6KGP631K2X2XXCA1	17
129876	TLR295P200	53	402963	6KGP43900X1RXXA1	16	403189	6KGP43002X4XBXA1	19	403605	6KGP631K3X2XXCA1	17
129877	TLR35P1500	53	402964	6KGP431K0X1RXXA1	16	403190	6KGP43003X4XBXA1	19	403658	6KGP63500X8XBXA1	15
129878	TLR29P1800	53	402965	6KGP431K2X1RXXA1	16	403191	6KGP43005X4XBXA1	19	403659	6KGP63550X8XBXA1	15
129879	TLR22P2500	53	402975	6KGP43F50X2RXXA1	18	403192	6KGP43007X4XBXA1	19	403660	6KGP63650X8XBXA1	15
129881	TLR15P3700	54	402976	6KGP43001X2RXXA1	18	403193	6KGP43010X4XBXA1	19	403661	6KGP63750X8XBXA1	15
129888	TLR35P3000	54	402977	6KGP43002X2RXXA1	18	403194	6KGP43015X4XBXA1	19	403662	6KGP63900X1XBXA1	15
400000			402978	6KGP43003X2RXXA1	18	403195	6KGP43020X4XBXA1	19	403663	6KGP631K0X1XBXA1	15
400412	6KGP43F50X9XXA1	15	402979	6KGP43005X2RXXA1	18	403196	6KGP43025X4XBXA1	19	403664	6KGP631K1X1XBXA1	15
400451	6KGP43001X9XXA1	15	402980	6KGP43007X2RXXA1	18	403197	6KGP43030X4XBXA1	19	403665	6KGP631K2X1XBXA1	15
401000			402981	6KGP43010X2RXXA1	18	403198	6KGP43040X4XBXA1	19	403666	6KGP631K3X1XBXA1	15
401212	6KGP43002X9XXA1	15	402982	6KGP43015X2RXXA1	18	403199	6KGP43050X4XBXA1	19	403666	6KGP63500X2XBXA1	17
401362	6KGP43003X9XXA1	15	402983	6KGP43020X2RXXA1	18	403200	6KGP43060X4XBXA1	19	403697	6KGP63550X2XBXA1	17
402000			402984	6KGP43025X2RXXA1	18	403201	6KGP43075X4XBXA1	19	403698	6KGP63650X2XBXA1	17
402735	6KGP43005X9XXA1	15	402985	6KGP43030X2RXXA1	18	403202	6KGP43100X4XBXA1	19	403699	6KGP63750X2XBXA1	17
402738	6KGP43007X9XXA1	15	402986	6KGP43040X2RXXA1	18	403203	6KGP43F50X9RXXA1	16	403700	6KGP63900X2XBXA1	17
402746	6KGP43010X9XXA1	15	402987	6KGP43050X2RXXA1	18	403204	6KGP43001X9RXXA1	16	403701	6KGP631K0X2XBXA1	17
402747	6KGP43015X9XXA1	15	402988	6KGP43060X2RXXA1	18	403205	6KGP43002X9RXXA1	16	403702	6KGP631K1X2XBXA1	17
402748	6KGP43020X9XXA1	15	402989	6KGP43075X2RXXA1	18	403206	6KGP43003X9RXXA1	16	403703	6KGP631K2X2XBXA1	17
402765	6KGP43025X9XXA1	15	402990	6KGP43100X2RXXA1	18	403207	6KGP43005X9RXXA1	16	403704	6KGP631K3X2XBXA1	17
402766	6KGP43030X9XXA1	15	402997	6KGP43450X2RXXA1	18	403208	6KGP43007X9RXXA1	16	403741	6KGP63015X1XXCA1	15
402767	6KGP43040X9XXA1	15	402998	6KGP43500X2RXXA1	18	403209	6KGP43010X9RXXA1	16	403742	6KGP63020X1XXCA1	15
402768	6KGP43050X9XXA1	15	402999	6KGP43550X2RXXA1	18	403210	6KGP43015X9RXXA1	16	403743	6KGP63025X1XXCA1	15
402769	6KGP43060X9XXA1	15	403000			403211	6KGP43020X9RXXA1	16	403744	6KGP63030X1XXCA1	15
402857	6KGP43075X9XXA1	15	403094	6KGP43600X2RXXA1	18	403212	6KGP43025X9RXXA1	16	403745	6KGP63040X1XXCA1	15
402863	6KGP43100X9XXA1	15	403095	6KGP43650X2RXXA1	18	403213	6KGP43030X9RXXA1	16	403746	6KGP63050X1XXCA1	15
402870	6KGP43450X8XXCA1	15	403096	6KGP43750X2RXXA1	18	403214	6KGP43040X9RXXA1	16	403747	6KGP63060X1XXCA1	15
402871	6KGP43500X8XXCA1	15	403097	6KGP43900X2RXXA1	18	403215	6KGP43050X9RXXA1	16	403748	6KGP63075X1XXCA1	15
402872	6KGP43550X8XXCA1	15	403098	6KGP431K0X2RXXA1	18	403216	6KGP43060X9RXXA1	16	403749	6KGP63100X1XXCA1	15
402873	6KGP43600X1XXCA1	15	403099	6KGP431K2X2RXXA1	18	403217	6KGP43075X9RXXA1	16	403750	6KGP63015X2XXCA1	17
402874	6KGP43650X1XXCA1	15	403100	6KGP43F50X4RXXA1	20	403218	6KGP43100X9RXXA1	16	403751	6KGP63020X2XXCA1	17
402875	6KGP43750X1XXCA1	15	403101	6KGP43001X4RXXA1	20	403225	6KGP43450X8RXXA1	16	403752	6KGP63025X2XXCA1	17
402876	6KGP43900X1XXCA1	15	403102	6KGP43002X4RXXA1	20	403226	6KGP43500X8RXXA1	16	403753	6KGP63030X2XXCA1	17
402877	6KGP431K0X1XXCA1	15	403103	6KGP43003X4RXXA1	20	403227	6KGP43550X8RXXA1	16	403754	6KGP63040X2XXCA1	17
402878	6KGP431K2X1XXCA1	15	403104	6KGP43005X4RXXA1	20	403228	6KGP43600X1RXXA1	16	403755	6KGP63050X2XXCA1	17
402888	6KGP43F50X2XXA1	17	403105	6KGP43007X4RXXA1	20	403229	6KGP43650X1RXXA1	16	403756	6KGP63060X2XXCA1	17
402889	6KGP43001X2XXA1	17	403106	6KGP43010X4RXXA1	20	403230	6KGP43750X1RXXA1	16	403757	6KGP63075X2XXCA1	17
402890	6KGP43002X2XXA1	17	403107	6KGP43015X4RXXA1	20	403231	6KGP43900X1RXXA1	16	403758	6KGP63100X2XXCA1	17
402891	6KGP43003X2XXA1	17	403108	6KGP43020X4RXXA1	20	403232	6KGP431K0X1RXXA1	16	403768	6KGP63015X1RXXA1	16
402892	6KGP43005X2XXA1	17	403109	6KGP43025X4RXXA1	20	403233	6KGP431K2X1RXXA1	16	403769	6KGP63020X1RXXA1	16
402893	6KGP43007X2XXA1	17	403110	6KGP43030X4RXXA1	20	403243	6KGP43F50X2RXXA1	18	403770	6KGP63025X1RXXA1	16
402894	6KGP43010X2XXA1	17	403111	6KGP43040X4RXXA1	20	403244	6KGP43001X2RXXA1	18	403771	6KGP63030X1RXXA1	16
402895	6KGP43015X2XXA1	17	403112	6KGP43050X4RXXA1	20	403245	6KGP43002X2RXXA1	18	403772	6KGP63040X1RXXA1	16
402896	6KGP43020X2XXA1	17	403113	6KGP43060X4RXXA1	20	403246	6KGP43003X2RXXA1	18	403773	6KGP63050X1RXXA1	16
402897	6KGP43025X2XXA1	17	403114	6KGP43075X4RXXA1	20	403247	6KGP43005X2RXXA1	18	403774	6KGP63060X1RXXA1	16
402898	6KGP43030X2XXA1	17	403115	6KGP43100X4RXXA1	20	403248	6KGP43007X2RXXA1	18	403775	6KGP63075X1RXXA1	16
402899	6KGP43040X2XXA1	17	403116	6KGP43F50X9XBXA1	15	403249	6KGP43010X2RXXA1	18	403776	6KGP63100X1RXXA1	16
402900	6KGP43050X2XXA1	17	403117	6KGP43001X9XBXA1	15	403250	6KGP43015X2RXXA1	18	403777	6KGP63015X2RXXA1	18
402901	6KGP43060X2XXA1	17	403118	6KGP43002X9XBXA1	15	403251	6KGP43020X2RXXA1	18	403778	6KGP63020X2RXXA1	18
402902	6KGP43075X2XXA1	17	403119	6KGP43003X9XBXA1	15	403252	6KGP43025X2RXXA1	18	403779	6KGP63025X2RXXA1	18
402903	6KGP43100X2XXA1	17	403120	6KGP43005X9XBXA1	15	403253	6KGP43030X2RXXA1	18	403780	6KGP63030X2RXXA1	18
402910	6KGP43450X2XXCA1	17	403121	6KGP43007X9XBXA1	15	403254	6KGP43040X2RXXA1	18	403781	6KGP63040X2RXXA1	18
402911	6KGP43500X2XXCA1	17	403122	6KGP43010X9XBXA1	15	403255	6KGP43050X2RXXA1	18	403782	6KGP63050X2RXXA1	18
402912	6KGP43550X2XXCA1	17	403123	6KGP43015X9XBXA1	15	403256	6KGP43060X2RXXA1	18	403783	6KGP63060X2RXXA1	18
402913	6KGP43600X2XXCA1	17	403124	6KGP43020X9XBXA1	15	403257	6KGP43075X2RXXA1	18	403784	6KGP63075X2RXXA1	18
402914	6KGP43650X2XXCA1	17	403125	6KGP43025X9XBXA1	15	403258	6KGP43100X2RXXA1	18	403785	6KGP63100X2RXXA1	18
402915	6KGP43750X2XXCA1	17	403126	6KGP43030X9XBXA1	15	403265	6KGP43450X2RXXA1	18	403795	6KGP63015X1RXXA1	15
402916	6KGP43900X2XXCA1	17	403127	6KGP43040X9XBXA1	15	403266	6KGP43500X2RXXA1	18	403796	6KGP63020X1RXXA1	15
402917	6KGP431K0X2XXCA1	17	403128	6KGP43050X9XBXA1	15	403267	6KGP43550X2RXXA1	18	403797	6KGP63025X1RXXA1	15
402918	6KGP431K2X2XXCA1	17	403129	6KGP43060X9XBXA1	15	403268	6KGP43600X2RXXA1	18	403798	6KGP63030X1RXXA1	15
402919	6KGP43F50X4XXA1	19	403130	6KGP43075X9XBXA1	15	403269	6KGP43650X2RXXA1	18	403799	6KGP63040X1RXXA1	15
402920	6KGP43001X4XXA1	19	403131	6KGP43100X9XBXA1	15	403270	6KGP43750X2RXXA1	18	403800	6KGP63050X1RXXA1	15
402921	6KGP43002X4XXA1	19	403138	6KGP43450X8XBXA1	15	403271	6KGP43900X2RXXA1	18	403801	6KGP63060X1RXXA1	15
402922	6KGP43003X4XXA1	19	403139	6KGP43500X8XBXA1	15	403272	6KGP431K0X2RXXA1	18	403802	6KGP63075X1RXXA1	15
402923	6KGP43005X4XXA1	19	403140	6KGP43550X8XBXA1	15	403273	6KGP431K2X2RXXA1	18	403803	6KGP63100X1RXXA1	15
402924	6KGP43007X4XXA1	19	403141	6KGP43600X1RXXA1	15	403274	6KGP43F50X4RXXA1	20	403804	6KGP63015X2RXXA1	17
402925	6KGP43010X4XXA1	19	403142	6KGP43650X1RXXA1	15	403275	6KGP43001				

Ref. nr.	Art.	Pag.	Ref. nr.	Art.	Pag.	Ref. nr.	Art.	Pag.	Ref. nr.	Art.	Pag.
403830	6KGP63100X1RBCA1	16	404468	6KFP43050X2RXXA1	36	404785	6KLP43F50X9A1	9	409607	6KGP43125X9RXC81	16
403831	6KGP63015X2RBCA1	18	404469	6KFP43060X2RXXA1	36	404786	6KLP43001X9A1	9	409608	6KGP43150X9RXC81	16
403832	6KGP63020X2RBCA1	18	404470	6KFP43075X2RXXA1	36	404787	6KLP43002X9A1	9	409609	6KGP43200X9RXC81	16
403833	6KGP63025X2RBCA1	18	404471	6KFP43100X2RXXA1	36	404788	6KLP43003X9A1	9	409610	6KGP43250X9RXC81	16
403834	6KGP63030X2RBCA1	18	404472	6KFP43125X2RXXA1	36	404789	6KLP43005X9A1	9	409611	6KGP43300X9RXC81	16
403835	6KGP63040X2RBCA1	18	404528	6KFP43500X2RXXA1	36	404790	6KLP43007X9A1	9	409612	6KGP43350X9RXC81	16
403836	6KGP63050X2RBCA1	18	404529	6KFP43550X2RXXA1	36	404791	6KLP43010X9A1	9	409613	6KGP43125X2RXC81	18
403837	6KGP63060X2RBCA1	18	404532	6KFP43600X2RXXA1	36	404792	6KLP43015X9A1	9	409614	6KGP43200X2RXC81	18
403838	6KGP63075X2RBCA1	18	404533	6KFP43650X2RXXA1	36	404793	6KLP43020X9A1	9	409615	6KGP43200X2RXC81	18
403839	6KGP63100X2RBCA1	18	404534	6KFP43700X2RXXA1	36	404794	6KLP43025X9A1	9	409616	6KGP43250X2RXC81	18
403855	6KFP43001X9XXXA1	33	404535	6KFP43900X2RXXA1	36	404795	6KLP43030X9A1	9	409617	6KGP43300X2RXC81	18
403856	6KFP43002X9XXXA1	33	404536	6KFP431K0X2RXXA1	36	404797	RMKYPDAACL1	10	409618	6KGP43350X2RXC81	18
403857	6KFP43003X9XXXA1	33	404537	6KFP431K2X2RXXA1	36	404798	NEMA1ACL1	10	409619	6KGP43125X9RXC81	15
403858	6KFP43005X9XXXA1	33	404538	6KFP431K3X2RXXA1	36	404799	NEMA1ACL2	10	409620	6KGP43150X9RXC81	15
403859	6KFP43007X9XXXA1	33	404670	6KGP23F3F3X9XXXA1	15	404800	NEMA1ACL3	10	409621	6KGP43200X9RXC81	15
403860	6KFP43010X9XXXA1	33	404671	6KGP23F50X9XXXA1	15	404801	NEMA1ACL4	10	409622	6KGP43250X9RXC81	15
403861	6KFP43015X9XXXA1	33	404672	6KGP23001X9XXXA1	15	404802	NEMA1ACL5	10	409623	6KGP43300X9RXC81	15
403862	6KFP43020X9XXXA1	33	404673	6KGP23002X9XXXA1	15	404803	DEPLTACL3	10	409624	6KGP43350X9RXC81	15
403863	6KFP43025X9XXXA1	33	404674	6KGP23003X9XXXA1	15	404804	DEPLTACL1	10	409626	6KGP43125X2RXC81	17
403864	6KFP43030X9XXXA1	33	404675	6KGP23005X9XXXA1	15	404805	DEPLTACL2	10	409628	6KGP43150X2RXC81	17
403865	6KFP43040X9XXXA1	33	404676	6KGP23007X9XXXA1	15	404806	RMAACL1	10	409630	6KGP43200X2RXC81	17
403866	6KFP43050X9XXXA1	33	404677	6KGP23010X9XXXA1	15	404815	OPC24VPS	22	409631	6KGP43250X2RXC81	17
403867	6KFP43060X9XXXA1	33	404678	6KGP23015X9XXXA1	15	404816	OPCAIO	40	409632	6KGP43300X2RXC81	17
403868	6KFP43075X9XXXA1	33	404679	6KGP23020X9XXXA1	15	404817	OPCBAC	39	409633	6KGP43350X2RXC81	17
403869	6KFP43100X9XXXA1	33	404680	6KGP23025X9XXXA1	15	404818	OPCDEV	21	409634	6KGP43125X9RXC81	16
403870	6KFP43125X9XXXA1	33	404681	6KGP23030X9XXXA1	15	404819	OPCENC	22	409635	6KGP43150X9RXC81	16
403877	6KFP43008X8XXA1	33	404682	6KGP23040X9XXXA1	15	404820	OPCEIP	21	409636	6KGP43200X9RXC81	16
403878	6KFP43550X8XXA1	33	404683	6KGP23050X9XXXA1	15	404821	OPCGPIO	22	409637	6KGP43250X9RXC81	16
403879	6KFP43600X8XXA1	33	404684	6KFP23001X9XXXA1	33	404822	OPCSTERM	23	409638	6KGP43300X9RXC81	16
403880	6KFP43650X1XXCA1	33	404685	6KFP23002X9XXXA1	33	404823	OPCLON	39	409639	6KGP43350X9RXC81	16
403881	6KFP43750X1XXCA1	33	404686	6KFP23003X9XXXA1	33	404824	OPCMBTCP	21	409640	6KGP43125X2RXC81	18
403882	6KFP43900X1XXCA1	33	404687	6KFP23005X9XXXA1	33	404825	OPCPRT	21	409641	6KGP43150X2RXC81	18
403883	6KFP431K0X1XXCA1	33	404688	6KFP23007X9XXXA1	33	404831	NEMA1ACA2	21	409642	6KGP43200X2RXC81	18
403884	6KFP431K2X1XXCA1	33	404689	6KFP23010X9XXXA1	33	404832	NEMA1ACA3	21	409643	6KGP43250X2RXC81	18
403885	6KFP431K3X1XXCA1	33	404690	6KFP23015X9XXXA1	33	404833	NEMA1ACB3	21	409644	6KGP43300X2RXC81	18
403886	6KFP43001X2XXXA1	35	404691	6KFP23020X9XXXA1	33	404834	NEMA1ACB4	21	409645	6KGP43350X2RXC81	18
403887	6KFP43002X2XXXA1	35	404692	6KFP23025X9XXXA1	33	404835	NEMA1ACC3	21	409646	6KGP43125X2RXC81	17
403888	6KFP43003X2XXXA1	35	404693	6KFP23030X9XXXA1	33	404836	NEMA1ACC4	21	409647	6KGP43150X2RXC81	17
403889	6KFP43005X2XXXA1	35	404694	6KFP23040X9XXXA1	33	404847	OPCCOVERS1	23	409648	6KGP43200X2RXC81	17
403890	6KFP43007X2XXXA1	35	404695	6KFP23050X9XXXA1	33	404848	OPCPDP	21	409649	6KGP43250X2RXC81	17
403891	6KFP43010X2XXXA1	35	404696	6KFP23060X9XXXA1	33	404849	OPCRLY	22	409650	6KGP43300X2RXC81	17
403892	6KFP43015X2XXXA1	35	404697	6KFP23012X2XXXA1	35	404850	OPCRMKNC	21	409651	6KGP63125X9RXC81	15
403893	6KFP43020X2XXXA1	35	404698	6KFP23002X2XXXA1	35	404851	RMKYPDAC	21	409652	6KGP63150X9RXC81	15
403894	6KFP43025X2XXXA1	35	404699	6KFP23003X2XXXA1	35	404852	OPCRS	22	409653	6KGP63200X9RXC81	15
403895	6KFP43030X2XXXA1	35	404700	6KFP23005X2XXXA1	35	404853	OPCSAFE	22	409654	6KGP63250X9RXC81	15
403896	6KFP43040X2XXXA1	35	404701	6KFP23007X2XXXA1	35	404860	OPCUSB6X	23	409655	6KGP63300X9RXC81	15
403897	6KFP43050X2XXXA1	35	404702	6KFP23010X2XXXA1	35	404861	OPCUSB	23	409656	6KGP63350X9RXC81	15
403898	6KFP43060X2XXXA1	35	404703	6KFP23015X2XXXA1	35	404865	6KFP63015X1RXC1	34	409657	6KGP63450X9RXC81	15
403899	6KFP43075X2XXXA1	35	404704	6KFP23020X2XXXA1	35	404866	6KFP63015X1XXCA1	33	409658	6KGP63125X2RXC81	17
403900	6KFP43100X2XXXA1	35	404705	6KFP23025X2XXXA1	35	404867	6KFP63015X2RXC1	36	409659	6KGP63150X2RXC81	17
403901	6KFP43125X2XXXA1	35	404706	6KFP23030X2XXXA1	35	404868	6KFP63015X2XXCA1	35	409660	6KGP63200X2RXC81	17
403908	6KFP43500X2XXCA1	35	404707	6KFP23040X2XXXA1	35	404869	6KFP63020X1RXC1	34	409661	6KGP63250X2RXC81	17
403909	6KFP43550X2XXCA1	35	404708	6KFP23050X2XXXA1	35	404870	6KFP63020X1XXCA1	33	409662	6KGP63300X2RXC81	17
403910	6KFP43600X2XXCA1	35	404709	6KFP23060X2XXXA1	35	404871	6KFP63020X2RXC1	36	409663	6KGP63350X2RXC81	17
403911	6KFP43650X2XXCA1	35	404710	6KGP23F3F3X2XXXA1	17	404872	6KFP63020X2XXCA1	35	409664	6KGP63450X2RXC81	17
403912	6KFP43750X2XXCA1	35	404711	6KGP23F50X2XXXA1	17	404873	6KFP63025X1RXC1	34	409665	6KGP63125X9RXC81	15
403913	6KFP43900X2XXCA1	35	404712	6KGP23001X2XXXA1	17	404874	6KFP63025X1XXCA1	33	409666	6KGP63150X9RXC81	15
403914	6KFP431K0X2XXCA1	35	404713	6KGP23002X2XXXA1	17	404875	6KFP63025X2RXC1	36	409667	6KGP63200X9RXC81	15
403915	6KFP431K2X2XXCA1	35	404714	6KGP23003X2XXXA1	17	404876	6KFP63025X2XXCA1	35	409668	6KGP63250X9RXC81	15
403916	6KFP431K3X2XXCA1	35	404715	6KGP23005X2XXXA1	17	404877	6KFP63030X1RXC1	34	409669	6KGP63300X9RXC81	15
403973	6KFP43001X9RXXA1	34	404716	6KGP23007X2XXXA1	17	404878	6KFP63030X1XXCA1	33	409670	6KGP63350X9RXC81	15
403974	6KFP43002X9RXXA1	34	404717	6KGP23010X2XXXA1	17	404879	6KFP63030X2RXC1	36	409671	6KGP63450X9RXC81	15
403975	6KFP43003X9RXXA1	34	404718	6KGP23015X2XXXA1	17	404880	6KFP63030X2XXCA1	35	409672	6KGP63125X2RXC81	17
403976	6KFP43005X9RXXA1	34	404719	6KGP23020X2XXXA1	17	404881	6KFP63040X1RXC1	34	409673	6KGP63150X2RXC81	17
403977	6KFP43007X9RXXA1	34	404720	6KGP23025X2XXXA1	17	404882	6KFP63040X1XXCA1	33	409674	6KGP63200X2RXC81	17
403978	6KFP43010X9RXXA1	34	404721	6KGP23030X2XXXA1	17	404883	6KFP63040X2RXC1	36	409675	6KGP63250X2RXC81	17
403979	6KFP43015X9RXXA1	34	404722	6KGP23040X2XXXA1	17	404884	6KFP63040X2XXCA1	35	409676	6KGP63300X2RXC81	17
403980	6KFP43020X9RXXA1	34	404723	6KGP23050X2XXXA1	17	404885	6KFP63050X1RXC1	34	409677	6KGP63350X2RXC81	17
403981	6KFP43025X9RXXA1	34	404724	6KGP23F3F3X4XXXA1	19	404886	6KFP63050X1XXCA1	33	409678	6KGP63450X2RXC81	17
403982	6KFP43030X9RXXA1	34	404725	6KGP23F50X4XXXA1	19	404887	6KFP63050X2RXC1	36	409679	6KFP43150X9RXC81	33
403983	6KFP43040X9RXXA1	34	404726	6KGP23001X4XXXA1	19	404888	6KFP63050X2XXCA1	35	409680	6KFP43200X9RXC81	33
403984	6KFP43050X9RXXA1	34	404727	6KGP23002X4XXXA1	19	404889	6KFP63060X1RXC1	34	409682	6KFP43250X9RXC81	33
403985	6KFP43060X9RXXA1	34	404728	6KGP23003X4XXXA1	19	404890	6KFP63060X1XXCA1	33	409683	6KFP43300X9RXC81	33
403986	6KFP43075X9RXXA1	34	404729	6KGP23005X4XXXA1	19	404891	6KFP63060X2RXC1	36	409684	6KFP43350X9RXC81	33
403987	6KFP43100X9RXXA1	34	404730	6KGP23007X4XXXA1	19	404892	6KFP63060X2XXCA1	35	409685	6KFP43450X9RXC81	33
403988	6KFP43125X9RXXA1	34	404731	6KGP23010X4XXXA1	19	404893	6KFP63075X1RXC1	34	409686	6KFP43150X2RXC81	35
403995	6KFP43500X8RXC1	34	404732	6KGP23015X4XXXA1	19	404894	6KFP63075X1XXCA1	33	409687	6KFP43200X2RXC81	35
403996	6KFP43550X8RXC1	34	404733	6KGP23020X4XXXA1	19	404895	6KFP63075X2RXC1	36	409688	6KFP43250X2RXC81	35
403997	6KFP43600X8RXC1	34	404734	6KGP23025X4XXXA1	19	404896	6KFP63075X2XXCA1	35	409689	6KFP43300X2RXC81	35
403998	6KFP43650X1RXC1	34	404735	6KGP23030X4XXXA1	19	404897	6KFP63100X1RXC1	34	409690	6KFP43350X2RXC81	35
403999	6KFP43750X1RXC1	34	404736	6KGP23040X4XXXA1	19	404898	6KFP63100X1XXCA1	33	409691	6KFP43450X2RXC81	35
404000	6KFP43900X1RXC1	34	404737	6KGP23050X4XXXA1	19	404899	6KFP63100X2RXC1	36	409692	6KFP43150X9RXC81	34
404000	6KFP43900X1RXC1	34	404738	6KGP631K6X1RXC1	15	404900	6KFP63100X2XXCA1	35	409693	6KFP43200X9RXC81	34</

By article number

Art.	Ref. nr. Pag.	Art.	Ref. nr. Pag.	Art.	Ref. nr. Pag.	Art.	Ref. nr. Pag.
6...		6KFP43005X2RXXA1	403889 35	6KFP43250X2RXC1	409688 35	6KFP631K3X2RXC1	35
6KFP23001X2RXXA1	36	6KFP43005X4RXXA1	37	6KFP43250X9RXC1	409694 34	6KFP631K6X1RXC1	34
6KFP23001X2XXA1	404697 35	6KFP43005X4XXA1	38	6KFP43250X9XC1	409682 33	6KFP631K6X1XC1	33
6KFP23001X4RXXA1	38	6KFP43005X9RXXA1	403976 34	6KFP43300X2RXC1	409706 36	6KFP631K6X2RXC1	36
6KFP23001X4XXA1	37	6KFP43005X9XXA1	403858 33	6KFP43300X2XC1	409689 35	6KFP631K6X2XC1	35
6KFP23001X9RXXA1	34	6KFP43007X2RXXA1	404387 36	6KFP43300X9RXC1	409695 34	6KFP631K9X1RXC1	34
6KFP23001X9XXA1	404684 33	6KFP43007X2XXA1	403890 35	6KFP43300X9XC1	409683 33	6KFP631K9X1XC1	33
6KFP23002X2RXXA1	36	6KFP43007X4RXXA1	38	6KFP43350X2RXC1	409707 36	6KFP63200X2RXC1	36
6KFP23002X2XXA1	404698 35	6KFP43007X4XXA1	37	6KFP43350X2XC1	409690 35	6KFP63200X2XC1	35
6KFP23002X4RXXA1	38	6KFP43007X9RXXA1	403977 34	6KFP43350X9RXC1	409700 34	6KFP63200X9RXC1	34
6KFP23002X4XXA1	37	6KFP43007X9XXA1	403859 33	6KFP43350X9XC1	409684 33	6KFP63200X9XC1	33
6KFP23002X9RXXA1	34	6KFP43010X2RXXA1	404388 36	6KFP43450X2RXC1	409708 36	6KFP63250X2RXC1	36
6KFP23002X9XXA1	404685 33	6KFP43010X2XXA1	403891 35	6KFP43450X2XC1	409691 35	6KFP63250X2XC1	35
6KFP23003X2RXXA1	36	6KFP43010X4RXXA1	38	6KFP43450X9RXC1	409702 34	6KFP63250X9RXC1	34
6KFP23003X2XXA1	404699 35	6KFP43010X4XXA1	37	6KFP43450X9XC1	409685 33	6KFP63250X9XC1	33
6KFP23003X4RXXA1	38	6KFP43010X9RXXA1	403978 34	6KFP43500X2RXC1	404528 36	6KFP63300X2RXC1	36
6KFP23003X4XXA1	37	6KFP43010X9XXA1	403860 33	6KFP43500X2XC1	403908 35	6KFP63300X2XC1	35
6KFP23003X9RXXA1	34	6KFP43015X2RXXA1	404389 36	6KFP43500X8RXC1	403995 34	6KFP63300X8RXC1	34
6KFP23003X9XXA1	404686 33	6KFP43015X2XXA1	403892 35	6KFP43500X8XC1	403877 33	6KFP63300X9XC1	33
6KFP23005X2RXXA1	36	6KFP43015X4RXXA1	38	6KFP43550X2RXC1	404529 36	6KFP63350X2RXC1	36
6KFP23005X2XXA1	404700 35	6KFP43015X4XXA1	37	6KFP43550X2XC1	403909 35	6KFP63350X2XC1	35
6KFP23005X4RXXA1	38	6KFP43015X9RXXA1	403979 34	6KFP43550X8RXC1	403996 34	6KFP63350X8RXC1	34
6KFP23005X4XXA1	37	6KFP43015X9XXA1	403861 33	6KFP43550X8XC1	403878 33	6KFP63350X8XC1	33
6KFP23005X9RXXA1	34	6KFP43020X2RXXA1	404464 36	6KFP43600X2RXC1	404532 36	6KFP63400X2RXC1	36
6KFP23005X9XXA1	404687 33	6KFP43020X2XXA1	403893 35	6KFP43600X2XC1	403910 35	6KFP63450X2RXC1	35
6KFP23007X2RXXA1	36	6KFP43020X4RXXA1	38	6KFP43600X8RXC1	403997 34	6KFP63450X8RXC1	34
6KFP23007X2XXA1	404701 35	6KFP43020X4XXA1	37	6KFP43650X8XC1	403879 33	6KFP63450X8XC1	33
6KFP23007X4RXXA1	38	6KFP43020X9RXXA1	403980 34	6KFP43650X1RXC1	403998 34	6KFP63500X2RXC1	36
6KFP23007X4XXA1	37	6KFP43020X9XXA1	403862 33	6KFP43650X1XC1	403880 33	6KFP63500X2XC1	35
6KFP23007X9RXXA1	34	6KFP43025X2RXXA1	404465 36	6KFP43650X2RXC1	404533 36	6KFP63550X2RXC1	36
6KFP23007X9XXA1	404688 33	6KFP43025X2XXA1	403894 35	6KFP43650X2XC1	403911 35	6KFP63550X9RXC1	34
6KFP23010X2RXXA1	36	6KFP43025X4RXXA1	38	6KFP43750X1RXC1	403999 34	6KFP63550X9XC1	33
6KFP23010X2XXA1	404702 35	6KFP43025X4XXA1	37	6KFP43750X1XC1	403881 33	6KFP63600X8RXC1	34
6KFP23010X4RXXA1	38	6KFP43025X9RXXA1	403981 34	6KFP43750X2RXC1	404534 36	6KFP63600X8XC1	36
6KFP23010X4XXA1	37	6KFP43025X9XXA1	403863 33	6KFP43750X2XC1	403912 35	6KFP63650X2RXC1	35
6KFP23010X9RXXA1	34	6KFP43030X2RXXA1	404466 36	6KFP43900X1RXC1	404000 34	6KFP63650X2XC1	35
6KFP23010X9XXA1	404689 33	6KFP43030X2XXA1	403895 35	6KFP43900X1XC1	403882 33	6KFP63650X8RXC1	34
6KFP23015X2RXXA1	36	6KFP43030X4RXXA1	38	6KFP43900X2RXC1	404535 36	6KFP63650X8XC1	36
6KFP23015X2XXA1	404703 35	6KFP43030X4XXA1	37	6KFP43900X2XC1	403913 35	6KFP63750X2RXC1	35
6KFP23015X4RXXA1	38	6KFP43030X9RXXA1	403982 34	6KFP63015X1RXC1	404865 34	6KFP63750X2XC1	35
6KFP23015X4XXA1	37	6KFP43030X9XXA1	403864 33	6KFP63015X1XC1	404866 33	6KFP63750X8RXC1	34
6KFP23015X9RXXA1	34	6KFP43040X2RXXA1	404467 36	6KFP63015X2RXC1	404867 36	6KFP63750X8XC1	36
6KFP23015X9XXA1	404690 33	6KFP43040X2XXA1	403896 35	6KFP63015X2XC1	404868 35	6KFP63900X2RXC1	36
6KFP23020X2RXXA1	36	6KFP43040X4RXXA1	38	6KFP63020X1RXC1	404869 34	6KFP63900X2XC1	35
6KFP23020X2XXA1	404704 35	6KFP43040X4XXA1	37	6KFP63020X1XC1	404870 33	6KFP63900X8RXC1	34
6KFP23020X4RXXA1	38	6KFP43040X9RXXA1	403983 34	6KFP63020X2RXC1	404871 36	6KFP63900X8XC1	36
6KFP23020X4XXA1	37	6KFP43040X9XXA1	403865 33	6KFP63020X2XC1	404872 35	6KGP23001X2RXC1	18
6KFP23020X9RXXA1	34	6KFP43050X2RXXA1	404468 36	6KFP63025X1RXC1	404873 34	6KGP23001X2XXA1	17
6KFP23020X9XXA1	404691 33	6KFP43050X2XXA1	403897 35	6KFP63025X1XC1	404874 33	6KGP23001X2XXA1	404712 17
6KFP23025X2RXXA1	36	6KFP43050X4RXXA1	38	6KFP63025X2RXC1	404875 36	6KGP23001X4RXC1	20
6KFP23025X2XXA1	404705 35	6KFP43050X4XXA1	37	6KFP63025X2XC1	404876 35	6KGP23001X4RXXA1	19
6KFP23025X4RXXA1	38	6KFP43050X9RXXA1	403984 34	6KFP63030X1RXC1	404877 34	6KGP23001X4RXXA1	404726 19
6KFP23025X4XXA1	37	6KFP43050X9XXA1	403866 33	6KFP63030X1XC1	404878 33	6KGP23001X4RXXA1	19
6KFP23025X9RXXA1	34	6KFP43060X2RXXA1	404469 36	6KFP63030X2RXC1	404879 36	6KGP23001X4RXXA1	404726 19
6KFP23025X9XXA1	404692 33	6KFP43060X2XXA1	403898 35	6KFP63030X2XC1	404880 35	6KGP23001X9RXC1	16
6KFP23030X2RXXA1	36	6KFP43060X4RXXA1	38	6KFP63040X1RXC1	404881 34	6KGP23001X9RXXA1	15
6KFP23030X2XXA1	404706 35	6KFP43060X4XXA1	37	6KFP63040X1XC1	404882 33	6KGP23001X9RXXA1	404672 15
6KFP23030X4RXXA1	38	6KFP43060X9RXXA1	403985 34	6KFP63040X2RXC1	404883 36	6KGP23002X2RXC1	18
6KFP23030X4XXA1	37	6KFP43060X9XXA1	403867 33	6KFP63040X2XC1	404884 35	6KGP23002X2RXC1	17
6KFP23030X9RXXA1	34	6KFP43075X2RXXA1	404470 36	6KFP63050X1RXC1	404885 34	6KGP23002X2RXC1	18
6KFP23030X9XXA1	404693 33	6KFP43075X2XXA1	403899 35	6KFP63050X1XC1	404886 33	6KGP23002X2RXC1	17
6KFP23040X2RXXA1	36	6KFP43075X4RXXA1	38	6KFP63050X2RXC1	404887 36	6KGP23002X2XXA1	404713 17
6KFP23040X2XXA1	404707 35	6KFP43075X4XXA1	37	6KFP63050X2XC1	404888 35	6KGP23002X4RXC1	20
6KFP23040X4RXXA1	38	6KFP43075X9RXXA1	403986 34	6KFP63060X1RXC1	404889 34	6KGP23002X4RXC1	19
6KFP23040X4XXA1	37	6KFP43075X9XXA1	403868 33	6KFP63060X1XC1	404890 33	6KGP23002X4RXC1	19
6KFP23040X9RXXA1	34	6KFP43100X2RXXA1	404471 36	6KFP63060X2RXC1	404891 36	6KGP23002X4RXC1	404727 19
6KFP23040X9XXA1	404694 33	6KFP43100X2XXA1	403900 35	6KFP63060X2XC1	404892 35	6KGP23002X9RXC1	16
6KFP23050X2RXXA1	36	6KFP43100X4RXXA1	38	6KFP63075X1RXC1	404893 34	6KGP23002X9RXC1	15
6KFP23050X2XXA1	404708 35	6KFP43100X4XXA1	37	6KFP63075X1XC1	404894 33	6KGP23002X9RXC1	15
6KFP23050X4RXXA1	38	6KFP43100X9RXXA1	403987 34	6KFP63075X2RXC1	404895 36	6KGP23002X9RXC1	404673 15
6KFP23050X4XXA1	37	6KFP43100X9XXA1	403869 33	6KFP63075X2XC1	404896 35	6KGP23003X2RXC1	18
6KFP23050X9RXXA1	34	6KFP43125X2RXXA1	404472 36	6KFP63100X1RXC1	404897 34	6KGP23003X2RXC1	18
6KFP23050X9XXA1	404695 33	6KFP43125X2XXA1	403901 35	6KFP63100X1XC1	404898 33	6KGP23003X2RXC1	17
6KFP23060X2RXXA1	36	6KFP43125X4RXXA1	38	6KFP63100X2RXC1	404899 36	6KGP23003X2XXA1	404714 17
6KFP23060X2XXA1	404709 35	6KFP43125X4XXA1	37	6KFP63100X2XC1	404900 35	6KGP23003X4RXC1	20
6KFP23060X4RXXA1	38	6KFP43125X9RXXA1	403988 34	6KFP63125X1RXC1	404901 34	6KGP23003X4RXC1	19
6KFP23060X4XXA1	37	6KFP43125X9XXA1	403870 33	6KFP63125X1XC1	404902 33	6KGP23003X4RXC1	19
6KFP23060X9RXXA1	34	6KFP43150X2RXC1	409703 36	6KFP63125X2RXC1	404903 36	6KGP23003X4RXC1	404728 19
6KFP23060X9XXA1	404696 33	6KFP43150X2XC1	409686 35	6KFP63125X2XC1	404904 35	6KGP23003X9RXC1	16
6KFP43001X2RXXA1	404209 36	6KFP43150X9RXC1	409692 34	6KFP63150X2RXC1	35	6KGP23003X9RXC1	16
6KFP43001X2XXA1	403886 35	6KFP43150X9XC1	409679 33	6KFP63150X2XC1	36	6KGP23003X9RXC1	15
6KFP43001X4RXXA1	38	6KFP431K0X1RXC1	404205 34	6KFP63150X9RXC1	34	6KGP23003X9RXC1	404674 15
6KFP43001X4XXA1	37	6KFP431K0X1XC1	403883 33	6KFP63150X9XC1	33	6KGP23005X4RXC1	18
6KFP43001X9RXXA1	403973 34	6KFP431K0X2RXC1	404536 36	6KFP631K0X1RXC1	34	6KGP23005X4RXC1	19
6KFP43001X9XXA1	403855 33	6KFP431K0X2XC1	403914 35	6KFP631K0X1XC1	33	6KGP23005X4RXC1	17
6KFP43002X2RXXA1	404210 36	6KFP431K2X1RXC1	404206 34	6KFP631K1X2RXC1	36	6KGP23005X4RXC1	404715 17
6KFP43002X2XXA1	403887 35	6KFP431K2X1XC1	403884 33	6KFP631K0X2RXC1	35	6KGP23005X4RXC1	20
6KFP43002X4RXXA1	38	6KFP431K2X2RXC1	404537 36	6KFP631K1X1RXC1	34	6KGP23005X4RXC1	20
6KFP43002X4XXA1	37	6KFP431K2X2XC1	403915 35	6KFP631K1X1XC1	33	6KGP23005X4RXC1	19
6KFP43002X9RXXA1	403974 34	6KFP431K3X1RXC1	404208 34	6KFP631K1X2RXC1	36	6KGP23005X4RXC1	404729 19
6KFP43002X9XXA1	403856 33	6KFP431K3X1XC1	403885 33	6KFP631K1X2XC1	35	6KGP23005X9RXC1	16
6KFP43003X2RXXA1	404263 36	6KFP431K3X2RXC1	404538 36	6KFP631K2X1RXC1	34	6KGP23005X9RXC1	15
6KFP43003X2XXA1	403888 35	6KFP431K3X2XC1	403916 35	6KFP631K0X1RXC1	33	6KGP23005X9RXC1	15
6KFP43003X4RXXA1	38	6KFP43200X2RXC1	409704 36	6KFP631K2X2RXC1			

Art.	Ref. nr.	Pag.	Art.	Ref. nr.	Pag.	Art.	Ref. nr.	Pag.	Art.	Ref. nr.	Pag.
6KGP23007X4R8XA1		20	6KGP23F33X4XBXA1		19	6KGP43015X9R8XA1	403210	16	6KGP43100X9XBXA1	403131	15
6KGP23007X4RXXA1		20	6KGP23F33X4XXXA1	404724	19	6KGP43015X9RXXA1	402942	16	6KGP43100X9XXA1	402863	15
6KGP23007X4R8XA1		19	6KGP23F33X9R8XA1		16	6KGP43015X9R8XA1	403123	15	6KGP43125X2R8CB1	409640	18
6KGP23007X4XXA1	404730	19	6KGP23F33X9RXXA1		16	6KGP43015X9RXXA1	402747	15	6KGP43125X2RXXA1	409613	18
6KGP23007X9R8XA1		16	6KGP23F33X9R8XA1		15	6KGP43020X2R8XA1	403251	18	6KGP43125X2R8CB1	409626	17
6KGP23007X9RXXA1		16	6KGP23F33X9RXXA1	404670	15	6KGP43020X2RXXA1	402983	18	6KGP43125X2XXCB1	409646	17
6KGP23007X9R8XA1		15	6KGP23F50X2R8XA1		18	6KGP43020X2RXXA1	403164	17	6KGP43125X9R8CB1	409634	16
6KGP23007X9XXA1	404676	15	6KGP23F50X2RXXA1		18	6KGP43020X2XXA1	402896	17	6KGP43125X9RXXA1	409607	16
6KGP23010X2R8XA1		18	6KGP23F50X2XBXA1		17	6KGP43020X4R8XA1	403282	20	6KGP43125X9R8CB1	409619	15
6KGP23010X2RXXA1		18	6KGP23F50X2XXA1	404711	17	6KGP43020X4RXXA1	403108	20	6KGP43125X9XXCB1	409600	15
6KGP23010X2XBXA1		17	6KGP23F50X4R8XA1		20	6KGP43020X4XBXA1	403195	19	6KGP43150X2R8CB1	409641	18
6KGP23010X2XXA1	404717	17	6KGP23F50X4RXXA1		20	6KGP43020X4XXA1	402927	19	6KGP43150X2RXXA1	409614	18
6KGP23010X4R8XA1		20	6KGP23F50X4XBXA1		19	6KGP43020X9R8XA1	403211	16	6KGP43150X2R8CB1	409628	17
6KGP23010X4RXXA1		20	6KGP23F50X4XXA1	404725	19	6KGP43020X9RXXA1	402943	16	6KGP43150X2XXCB1	409647	17
6KGP23010X4XBXA1		19	6KGP23F50X9R8XA1		16	6KGP43020X9R8XA1	403124	15	6KGP43150X9R8CB1	409635	16
6KGP23010X4XXA1	404731	19	6KGP23F50X9RXXA1		16	6KGP43020X9XXA1	402748	15	6KGP43150X9RXXA1	409608	16
6KGP23010X9R8XA1		16	6KGP23F50X9XBXA1		15	6KGP43025X2R8XA1	403252	18	6KGP43150X9R8CB1	409620	15
6KGP23010X9RXXA1		16	6KGP23F50X9XXA1	404671	15	6KGP43025X2RXXA1	402984	18	6KGP43150X9XXCB1	409601	15
6KGP23010X9R8XA1		15	6KGP43001X2R8XA1	403244	18	6KGP43025X2XBXA1	403165	17	6KGP431K0X1R8CA1	403232	16
6KGP23010X9XXA1	404677	15	6KGP43001X2RXXA1	402976	18	6KGP43025X2XXA1	402897	17	6KGP431K0X1RXXA1	402964	16
6KGP23015X2R8XA1		18	6KGP43001X2XBXA1	403157	17	6KGP43025X4R8XA1	403283	20	6KGP431K0X1R8CA1	403145	15
6KGP23015X2RXXA1		18	6KGP43001X2XXA1	402889	17	6KGP43025X4RXXA1	403109	20	6KGP431K0X1XXCA1	402877	15
6KGP23015X2XBXA1		17	6KGP43001X4R8XA1	403275	20	6KGP43025X4XBXA1	403196	19	6KGP431K0X2R8CA1	403272	18
6KGP23015X2XXA1	404718	17	6KGP43001X4RXXA1	403101	20	6KGP43025X4XXA1	402928	19	6KGP431K0X2RXXA1	403098	18
6KGP23015X4R8XA1		20	6KGP43001X4XBXA1	403188	19	6KGP43025X9R8XA1	403212	16	6KGP431K0X2R8CB1	403185	17
6KGP23015X4RXXA1		20	6KGP43001X4XXA1	402920	19	6KGP43025X9RXXA1	402944	16	6KGP431K0X2XXCA1	402917	17
6KGP23015X4XBXA1		19	6KGP43001X9R8XA1	403204	16	6KGP43025X9R8XA1	403125	15	6KGP431K2X1R8CA1	403233	16
6KGP23015X4XXA1	404732	19	6KGP43001X9RXXA1	402936	16	6KGP43025X9XXA1	402765	15	6KGP431K2X1RXXA1	402965	16
6KGP23015X9R8XA1		16	6KGP43001X9XBXA1	403117	15	6KGP43030X2R8XA1	403253	18	6KGP431K2X1R8CA1	403146	15
6KGP23015X9RXXA1		16	6KGP43001X9XXA1	400451	15	6KGP43030X2RXXA1	402985	18	6KGP431K2X1XXCA1	402878	15
6KGP23015X9R8XA1		15	6KGP43002X2R8XA1	403245	18	6KGP43030X2XBXA1	403166	17	6KGP431K2X2R8CA1	403273	18
6KGP23015X9XXA1	404678	15	6KGP43002X2RXXA1	402977	18	6KGP43030X2XXA1	402898	17	6KGP431K2X2RXXA1	403099	18
6KGP23020X2R8XA1		18	6KGP43002X2XBXA1	403158	17	6KGP43030X4R8XA1	403284	20	6KGP431K2X2R8CB1	403186	17
6KGP23020X2RXXA1		18	6KGP43002X2XXA1	402890	17	6KGP43030X4RXXA1	403110	20	6KGP431K2X2XXCA1	402918	17
6KGP23020X2XBXA1		17	6KGP43002X4R8XA1	403276	20	6KGP43030X4XBXA1	403197	19	6KGP43200X2R8CB1	409642	18
6KGP23020X2XXA1	404719	17	6KGP43002X4RXXA1	403102	20	6KGP43030X4XXA1	402929	19	6KGP43200X2RXXA1	409615	18
6KGP23020X4R8XA1		20	6KGP43002X4XBXA1	403189	19	6KGP43030X9R8XA1	403213	16	6KGP43200X2R8CB1	409630	17
6KGP23020X4RXXA1		20	6KGP43002X4XXA1	402921	19	6KGP43030X9RXXA1	402945	16	6KGP43200X2XXCB1	409648	17
6KGP23020X4XBXA1		19	6KGP43002X9R8XA1	403205	16	6KGP43030X9R8XA1	403126	15	6KGP43200X9R8CB1	409636	16
6KGP23020X4XXA1	404733	19	6KGP43002X9RXXA1	402937	16	6KGP43030X9XXA1	402766	15	6KGP43200X9RXXA1	409609	16
6KGP23020X9R8XA1		16	6KGP43002X9XBXA1	403118	15	6KGP43040X2R8XA1	403254	18	6KGP43200X9R8CB1	409621	15
6KGP23020X9RXXA1		16	6KGP43002X9XXA1	401212	15	6KGP43040X2RXXA1	402986	18	6KGP43200X9XXCB1	409602	15
6KGP23020X9R8XA1		15	6KGP43003X2R8XA1	403246	18	6KGP43040X2XBXA1	403167	17	6KGP43250X2R8CB1	409643	18
6KGP23020X9XXA1	404679	15	6KGP43003X2RXXA1	402978	18	6KGP43040X2XXA1	402899	17	6KGP43250X2RXXA1	409616	18
6KGP23025X2R8XA1		18	6KGP43003X2XBXA1	403159	17	6KGP43040X4R8XA1	403285	20	6KGP43250X2R8CB1	409631	17
6KGP23025X2RXXA1		18	6KGP43003X2XXA1	402891	17	6KGP43040X4RXXA1	403111	20	6KGP43250X2XXCB1	409649	17
6KGP23025X2XBXA1		17	6KGP43003X4R8XA1	403277	20	6KGP43040X4XBXA1	403198	19	6KGP43250X9R8CB1	409637	16
6KGP23025X2XXA1	404720	17	6KGP43003X4RXXA1	403103	20	6KGP43040X4XXA1	402930	19	6KGP43250X9RXXA1	409610	16
6KGP23025X4R8XA1		20	6KGP43003X4XBXA1	403190	19	6KGP43040X9R8XA1	403214	16	6KGP43250X9R8CB1	409622	15
6KGP23025X4RXXA1		20	6KGP43003X4XXA1	402922	19	6KGP43040X9RXXA1	402946	16	6KGP43250X9XXCB1	409603	15
6KGP23025X4XBXA1		19	6KGP43003X9R8XA1	403206	16	6KGP43040X9R8XA1	403127	15	6KGP43300X2R8CB1	409644	18
6KGP23025X4XXA1	404734	19	6KGP43003X9RXXA1	402938	16	6KGP43040X9XXA1	402767	15	6KGP43300X2RXXA1	409617	18
6KGP23025X9R8XA1		16	6KGP43003X9XBXA1	403119	15	6KGP43050X2R8XA1	403255	18	6KGP43300X2R8CB1	409632	17
6KGP23025X9RXXA1		16	6KGP43003X9XXA1	401362	15	6KGP43050X2RXXA1	402987	18	6KGP43300X2XXCB1	409650	17
6KGP23025X9R8XA1		15	6KGP43005X2R8XA1	403247	18	6KGP43050X2XBXA1	403168	17	6KGP43300X9R8CB1	409638	16
6KGP23025X9XXA1	404680	15	6KGP43005X2RXXA1	402979	18	6KGP43050X2XXA1	402900	17	6KGP43300X9RXXA1	409611	16
6KGP23030X2R8XA1		18	6KGP43005X2XBXA1	403160	17	6KGP43050X4R8XA1	403286	20	6KGP43300X9R8CB1	409623	15
6KGP23030X2RXXA1		18	6KGP43005X2XXA1	402892	17	6KGP43050X4RXXA1	403112	20	6KGP43300X9XXCB1	409604	15
6KGP23030X2XBXA1		16	6KGP43005X4R8XA1	403278	20	6KGP43050X4XBXA1	403199	19	6KGP43350X2R8CB1	409645	18
6KGP23030X2XXA1	404721	17	6KGP43005X4RXXA1	403104	20	6KGP43050X4XXA1	402931	19	6KGP43350X2RXXA1	409618	18
6KGP23030X4R8XA1		20	6KGP43005X4XBXA1	403191	19	6KGP43050X9R8XA1	403215	16	6KGP43350X2R8CB1	409633	17
6KGP23030X4RXXA1		20	6KGP43005X4XXA1	402923	19	6KGP43050X9RXXA1	402947	16	6KGP43350X2XXCB1	409606	17
6KGP23030X4XBXA1		19	6KGP43005X9R8XA1	403207	16	6KGP43050X9R8XA1	403128	15	6KGP43350X9R8CB1	409639	16
6KGP23030X4XXA1	404735	19	6KGP43005X9RXXA1	402939	16	6KGP43050X9XXA1	402768	15	6KGP43350X9RXXA1	409612	16
6KGP23030X9R8XA1		16	6KGP43005X9XBXA1	403120	15	6KGP43060X2R8XA1	403256	18	6KGP43350X9R8CB1	409624	15
6KGP23030X9RXXA1		16	6KGP43005X9XXA1	402735	15	6KGP43060X2RXXA1	402988	18	6KGP43350X9XXCB1	409605	15
6KGP23030X9R8XA1		15	6KGP43007X2R8XA1	403248	18	6KGP43060X2XBXA1	403169	17	6KGP43450X2R8CA1	403265	18
6KGP23030X9XXA1	404681	15	6KGP43007X2RXXA1	402980	18	6KGP43060X2XXA1	402901	17	6KGP43450X2RXXA1	402997	18
6KGP23040X2R8XA1		18	6KGP43007X2XBXA1	403161	17	6KGP43060X4R8XA1	403287	20	6KGP43450X2R8CB1	403178	17
6KGP23040X2RXXA1		16	6KGP43007X2XXA1	402893	17	6KGP43060X4RXXA1	403113	20	6KGP43450X2XXCA1	402910	17
6KGP23040X2XBXA1		17	6KGP43007X4R8XA1	403279	20	6KGP43060X4XBXA1	403200	19	6KGP43450X8R8CA1	403225	16
6KGP23040X2XXA1	404722	17	6KGP43007X4RXXA1	403105	20	6KGP43060X4XXA1	402932	19	6KGP43450X8RXXA1	402957	16
6KGP23040X4R8XA1		20	6KGP43007X4XBXA1	403192	19	6KGP43060X9R8XA1	403216	16	6KGP43450X8R8CB1	403138	15
6KGP23040X4RXXA1		20	6KGP43007X4XXA1	402924	19	6KGP43060X9RXXA1	402948	16	6KGP43450X8XXCA1	402870	15
6KGP23040X4XBXA1		19	6KGP43007X9R8XA1	403208	16	6KGP43060X9R8XA1	403129	15	6KGP43500X2R8CA1	403266	18
6KGP23040X4XXA1	404736	19	6KGP43007X9RXXA1	402940	16	6KGP43060X9RXXA1	402769	15	6KGP43500X2R8CB1	402998	18
6KGP23040X9R8XA1		16	6KGP43007X9R8XA1	403121	15	6KGP43075X2R8XA1	403257	18	6KGP43500X2RXXA1	403179	17
6KGP23040X9RXXA1		16	6KGP43007X9XXA1	402738	15	6KGP43075X2RXXA1	402989	18	6KGP43500X2XXCB1	402911	17
6KGP23040X9R8XA1		15	6KGP43010X2R8XA1	403249	18	6KGP43075X2XBXA1	403170	17	6KGP43500X8R8CA1	403226	16
6KGP23040X9XXA1	404682	15	6KGP43010X2RXXA1	402981	18	6KGP43075X2XXA1	402902	17	6KGP43500X8R8CB1	402958	16
6KGP23050X2R8XA1		18	6KGP43010X2XBXA1	403162	17	6KGP43075X4R8XA1	403288	20	6KGP43500X8RXXA1	403139	15
6KGP23050X2RXXA1		18	6KGP43010X2XXA1	402894	17	6KGP43075X4RXXA1	403114	20	6KGP43500X8XXCB1	402871	15
6KGP23050X2XBXA1		17	6KGP43010X4R8XA1	403280	20	6KGP43075X4XBXA1	403201	19	6KGP43500X2R8CB1	403267	18
6KGP23050X2XXA1	404723	17	6KGP43010X4RXXA1	403106	20	6KGP43075X4XXA1	402933	19			

## By article number

AF-6 drives

Art.	Ref. nr. Pag.	Art.	Ref. nr. Pag.	Art.	Ref. nr. Pag.	Art.	Ref. nr. Pag.
6KGP43650X1RBCA1	403229 16	6KGP63075X2RXC1	403784 18	6KGP63350X2XXCB1	409663 17	OPCMBTCP	404824 21
6KGP43650X1RXC1	402961 16	6KGP63075X2XBCA1	403811 17	6KGP63350X8RXC1	16	OPCPDP	404848 21
6KGP43650X1XBCA1	403142 15	6KGP63075X2XXCA1	403757 17	6KGP63350X9RBC1	16	OPCPED41H	409506 23
6KGP43650X1XXCA1	402874 15	6KGP63100X1RBCA1	403830 16	6KGP63350X9XBC1	409670 15	OPCPED42H	409507 23
6KGP43650X2RBCA1	403269 18	6KGP63100X1RXC1	403776 16	6KGP63350X9XXCB1	409656 15	OPCPRT	404825 21
6KGP43650X2RXC1	403095 18	6KGP63100X1XBCA1	403803 15	6KGP63450X2RBC1	18	OPCRES	404852 22
6KGP43650X2XBCA1	403182 17	6KGP63100X1XXCA1	403749 15	6KGP63450X2RXC1	18	OPCRLY	404849 22
6KGP43650X2XXCA1	402914 17	6KGP63100X2RBCA1	403839 18	6KGP63450X2XBC1	409678 17	OPCRMKNC	404850 21
6KGP43750X1RBCA1	403230 16	6KGP63100X2RXC1	403785 18	6KGP63450X2XXCB1	409664 17	OPCSAFE	404853 22
6KGP43750X1RXC1	402962 16	6KGP63100X2XBCA1	403812 17	6KGP63450X8RXC1	16	OPCSTERM	404822 23
6KGP43750X1XBCA1	403143 15	6KGP63100X2XXCA1	403758 17	6KGP63450X9RBC1	16	OPCUSB	404861 23
6KGP43750X1XXCA1	402875 15	6KGP63125X2RBC1	18	6KGP63450X9XCB1	409671 15	OPCUSB6X	404860 23
6KGP43750X2RBC1	403270 18	6KGP63125X2RXC1	18	6KGP63450X9XXCB1	409657 15	<b>R...</b>	
6KGP43750X2RXC1	403096 18	6KGP63125X2XBC1	409672 17	6KGP63500X2RBC1	18	RMACLP1	404806 10
6KGP43750X2XBC1	403183 17	6KGP63125X2XXCA1	409658 17	6KGP63500X2RXC1	18	RMKYPDAC	404851 21
6KGP43750X2XXCA1	402915 17	6KGP63125X8RXC1	16	6KGP63500X2XBC1	403696 17	RMKYPDACL1	404797 10
6KGP43900X1RBCA1	403231 16	6KGP63125X9RBC1	16	6KGP63500X2XXCA1	403597 17	<b>T...</b>	
6KGP43900X1RXC1	402963 16	6KGP63125X9XBC1	409665 15	6KGP63500X8RBC1	16	TLR118P600	129174 53
6KGP43900X1XBCA1	403144 15	6KGP63125X9XXCB1	409651 15	6KGP63500X8RXC1	16	TLR15P3700	129881 54
6KGP43900X1XXCA1	402876 15	6KGP63150X2RBC1	18	6KGP63500X8XBC1	403658 15	TLR216P200	129868 53
6KGP43900X2RBCA1	403271 18	6KGP63150X2RXC1	18	6KGP63500X8XXCA1	403561 15	TLR22P2500	129879 53
6KGP43900X2RXC1	403097 18	6KGP63150X2XBC1	409673 17	6KGP63550X2XBC1	403697 17	TLR295P200	129876 53
6KGP43900X2XBCA1	403184 17	6KGP63150X2XXCB1	409659 17	6KGP63550X2XCA1	403598 17	TLR295P200	129878 53
6KGP43900X2XXCA1	402916 17	6KGP63150X8RXC1	16	6KGP63550X8RBC1	403659 15	TLR29P600	129167 53
6KGP43F50X2RBC1	403243 18	6KGP63150X9RBC1	16	6KGP63550X8XXCA1	403562 15	TLR35P1500	129877 53
6KGP43F50X2RXC1	402975 18	6KGP63150X9XBC1	409666 15	6KGP63650X2RBC1	18	TLR35P3000	129888 54
6KGP43F50X2XXCA1	403156 17	6KGP63150X9XXCB1	409652 15	6KGP63650X2RXC1	18	TLR405P200	129867 54
6KGP43F50X2XXXXA1	402888 17	6KGP631K0X1RBCA1	16	6KGP63650X2XBCA1	403698 17	TLR432P200	129875 54
6KGP43F50X4RBCA1	403274 20	6KGP631K0X1RXC1	16	6KGP63650X2XXCA1	403599 17	TLR43P1000	129177 53
6KGP43F50X4RXC1	403100 20	6KGP631K0X1XBCA1	403663 15	6KGP63650X8RBC1	16	TLR44P600	129166 53
6KGP43F50X4XBCA1	403187 19	6KGP631K0X1XXCA1	403566 15	6KGP63650X8RXC1	16	TLR4P3000	129872 54
6KGP43F50X4XXCA1	402919 19	6KGP631K0X2RBCA1	18	6KGP63650X8XBC1	403660 15	TLR59P1000	129176 53
6KGP43F50X9RBC1	403203 16	6KGP631K0X2RXC1	18	6KGP63650X8XXCA1	403563 15	TLR5P2500	129871 54
6KGP43F50X9RXC1	402935 16	6KGP631K0X2XBCA1	403701 17	6KGP63750X2RBC1	18	TLR74P200	129870 53
6KGP43F50X9XBC1	403116 15	6KGP631K0X2XXCA1	403602 17	6KGP63750X2RXC1	18	TLR750P200	116301 54
6KGP43F50X9XXCB1	400412 15	6KGP631K1X1RBCA1	16	6KGP63750X2XBC1	403699 17	TLR8,8P1500	129171 54
6KGP63015X1RBCA1	403822 16	6KGP631K1X1RXC1	16	6KGP63750X2XXCA1	403600 17	TLR86P600	129175 53
6KGP63015X1RXC1	403768 16	6KGP631K1X1XBCA1	403664 15	6KGP63750X8RBC1	16		
6KGP63015X1XBCA1	403795 15	6KGP631K1X1XXCA1	403567 15	6KGP63750X8RXC1	16		
6KGP63015X1XXCA1	403741 15	6KGP631K1X2RBCA1	18	6KGP63750X8XBC1	403661 15		
6KGP63015X2RBCA1	403831 18	6KGP631K1X2RXC1	18	6KGP63750X8XXCA1	403564 15		
6KGP63015X2RXC1	403777 18	6KGP631K1X2XBCA1	403702 17	6KGP63900X1RBCA1	16		
6KGP63015X2XBCA1	403804 17	6KGP631K1X2XXCA1	403603 17	6KGP63900X1RXC1	16		
6KGP63015X2XXCA1	403750 17	6KGP631K2X1RBCA1	16	6KGP63900X1XBCA1	403662 15		
6KGP63020X1RBCA1	403823 16	6KGP631K2X1RXC1	16	6KGP63900X1XXCA1	403565 15		
6KGP63020X1RXC1	403769 16	6KGP631K2X1XBCA1	403665 15	6KGP63900X2RBCA1	18		
6KGP63020X1XBCA1	403796 15	6KGP631K2X1XXCA1	403568 15	6KGP63900X2RXC1	18		
6KGP63020X1XXCA1	403742 15	6KGP631K2X2RBCA1	18	6KGP63900X2XBCA1	403700 17		
6KGP63020X2RBCA1	403832 18	6KGP631K2X2RXC1	18	6KGP63900X2XXCA1	403601 17		
6KGP63020X2RXC1	403778 18	6KGP631K2X2XBCA1	403703 17	6KLP21001X9A1	404776 9		
6KGP63020X2XBCA1	403805 17	6KGP631K2X2XXCA1	403604 17	6KLP21002X9A1	404777 9		
6KGP63020X2XXCA1	403751 17	6KGP631K3X1RBCA1	16	6KLP21003X9A1	404778 9		
6KGP63025X1RBCA1	403824 16	6KGP631K3X1RXC1	16	6KLP21F25X9A1	404774 9		
6KGP63025X1RXC1	403770 16	6KGP631K3X1XBCA1	403666 15	6KLP21F50X9A1	404775 9		
6KGP63025X1XBCA1	403797 15	6KGP631K3X1XXCA1	403569 15	6KLP23001X9A1	404781 9		
6KGP63025X1XXCA1	403743 15	6KGP631K3X2RBCA1	18	6KLP23002X9A1	404782 9		
6KGP63025X2RBCA1	403833 18	6KGP631K3X2RXC1	18	6KLP23003X9A1	404783 9		
6KGP63025X2RXC1	403779 18	6KGP631K3X2XBCA1	403704 17	6KLP23005X9A1	404784 9		
6KGP63025X2XBCA1	403806 17	6KGP631K3X2XXCA1	403605 17	6KLP23F33X9A1	404779 9		
6KGP63025X2XXCA1	403752 17	6KGP631K6X1RBCA1	16	6KLP23F50X9A1	404780 9		
6KGP63030X1RBCA1	403825 16	6KGP631K6X1RXC1	16	6KLP43001X9A1	404786 9		
6KGP63030X1RXC1	403771 16	6KGP631K6X1XBCA1	404738 15	6KLP43002X9A1	404787 9		
6KGP63030X1XBCA1	403798 15	6KGP631K6X1XXCA1	404739 15	6KLP43003X9A1	404788 9		
6KGP63030X1XXCA1	403744 15	6KGP631K6X2RBCA1	18	6KLP43005X9A1	404789 9		
6KGP63030X2RBCA1	403834 18	6KGP631K6X2RXC1	18	6KLP43007X9A1	404790 9		
6KGP63030X2RXC1	403780 18	6KGP631K6X2XBCA1	404740 17	6KLP43010X9A1	404791 9		
6KGP63030X2XBCA1	403807 17	6KGP631K9X1RBCA1	16	6KLP43015X9A1	404792 9		
6KGP63030X2XXCA1	403753 17	6KGP631K9X1RXC1	16	6KLP43020X9A1	404793 9		
6KGP63040X1RBCA1	403826 16	6KGP631K9X2RBCA1	18	6KLP43025X9A1	404794 9		
6KGP63040X1RXC1	403772 16	6KGP631K9X2RXC1	18	6KLP43030X9A1	404795 9		
6KGP63040X1XBCA1	403799 15	6KGP63200X2RBC1	18	6KLP43F50X9A1	404785 9		
6KGP63040X1XRC1	403745 15	6KGP63200X2RXC1	18	<b>D...</b>			
6KGP63040X2RBCA1	403835 18	6KGP63200X2XBC1	409674 17	DEPLTACL1	404804 10		
6KGP63040X2RXC1	403781 18	6KGP63200X2XXCB1	409660 17	DEPLTACL2	404805 10		
6KGP63040X2XBCA1	403808 17	6KGP63200X8RXC1	16	DEPLTACL3	404803 10		
6KGP63040X2XXCA1	403754 17	6KGP63200X9RBC1	16	<b>N...</b>			
6KGP63050X1RBCA1	403827 16	6KGP63200X9XBC1	409667 15	NEMA1ACA2	404831 21		
6KGP63050X1RXC1	403773 16	6KGP63200X9XXCB1	409653 15	NEMA1ACA3	404832 21		
6KGP63050X1XBCA1	403800 15	6KGP63250X2RBC1	18	NEMA1ACB3	404833 21		
6KGP63050X1XXCA1	403746 15	6KGP63250X2RXC1	18	NEMA1ACB4	404834 21		
6KGP63050X2RBCA1	403836 18	6KGP63250X2XBC1	409675 17	NEMA1ACC3	404835 21		
6KGP63050X2RXC1	403782 18	6KGP63250X2XXCB1	409661 17	NEMA1ACC4	404836 21		
6KGP63050X2XBCA1	403809 17	6KGP63250X8RXC1	16	NEMA1ACL1P	404798 10		
6KGP63050X2XXCA1	403755 17	6KGP63250X9RBC1	16	NEMA1ACL1P2	404799 10		
6KGP63060X1RBCA1	403828 16	6KGP63250X9XBC1	409668 15	NEMA1ACL1P3	404800 10		
6KGP63060X1RXC1	403774 16	6KGP63250X9XXCB1	409654 15	NEMA1ACL1P4	404801 10		
6KGP63060X1XBCA1	403801 15	6KGP63300X2RBC1	18	NEMA1ACL1P5	404802 10		
6KGP63060X1XXCA1	403747 15	6KGP63300X2RXC1	18	<b>O...</b>			
6KGP63060X2RBCA1	403837 18	6KGP63300X2XBC1	409676 17	OPC24VPS	404815 22		
6KGP63060X2RXC1	403783 18	6KGP63300X2XXCB1	409662 17	OPCAIO	404816 40		
6KGP63060X2XBCA1	403810 17	6KGP63300X8RXC1	16	OPCBAC	404817 39		
6KGP63060X2XXCA1	403756 17	6KGP63300X9RBC1	16	OPCCOVER51	404847 23		
6KGP63075X1RBCA1	403829 16	6KGP63300X9XBC1	409669 15	OPCDEV	404818 21		
6KGP63075X1RXC1	403775 16	6KGP63300X9XXCB1	409655 15	OPCEIP	404820 21		
6KGP63075X1XBCA1	403802 15	6KGP63350X2RBC1	18	OPCENIO	404819 22		
6KGP63075X1XXCA1	403748 15	6KGP63350X2RXC1	18	OPCGPIO	404821 22		
6KGP63075X2RBCA1	403838 18	6KGP63350X2XBC1	409677 17	OPCLON	404823 39		

Non mentioned reference numbers are on request



The policy of GE Industrial Solutions is one of continuous improvement. The right is reserved to alter the design or any structural details of the products at any time without giving notice.

March 2014  
GE Industrial Solutions



GE Industrial Solutions is a first class global supplier of low and medium voltage products including wiring devices, residential and industrial electrical distribution components, automation products, enclosures and switchboards. Demand for the company's products comes from wholesalers, installers, panelboard builders, contractors, OEMs and utilities worldwide.

[www.ge.com/ex/industrialsolutions](http://www.ge.com/ex/industrialsolutions)  
[www.ge.com/uk/industrialsolutions](http://www.ge.com/uk/industrialsolutions)

**Belgium**

GE Industrial Belgium  
Nieuwevaart 51  
B-9000 Gent  
Tel. +32 (0)9 265 21 11

**Finland**

GE Industrial Solutions  
Kuortaneenkatu 2  
FI-00510 Helsinki  
Tel. +358 (0)10 394 3760

**France**

GE Industrial Solutions  
Paris Nord 2  
13, rue de la Perdrix  
F-95958 Roissy CDG Cédex  
Tel. +33 (0)800 912 816

**Germany**

GE Industrial Solutions  
Robert-Bosch Str. 2a  
D-50354 Hürth-Efferen  
Tel. +49 (0) 2233/ 9719-0

**Hungary**

GE Hungary Kft.  
Váci ut 81-83.  
H-1139 Budapest  
Tel. +36 1 447 6050

**Italy**

GE Industrial Solutions  
Centro Direzionale Colleoni  
Via Paracelso 16  
Palazzo Andromeda B1  
I-20864 Agrate Brianza (MB)  
Tel. +39 039 637 371

**Netherlands**

GE Industrial Solutions  
Parallelweg 10  
NI-7482 CA Haaksbergen  
Tel. +31 (0)53 573 03 03

**Poland**

GE Power Controls  
Ul. Odrowaza 15  
03-310 Warszawa  
Tel. +48 22 519 76 00

Ul. Leszczyńska 6

43-300 Bielsko-Biała  
Tel. +48 33 828 62 33

**Russia**

GE Industrial Solutions  
27/8, Electroavodskaya street  
Moscow, 107023  
Tel. +7 495 937 11 11

**South Africa**

GE Industrial Solutions  
Unit 4, 130 Gazelle Avenue  
Corporate Park Midrand 1685  
P.O. Box 76672 Wendywood 2144  
Tel. +27 11 238 3000

**Spain**

GE POWER CONTROLS IBÉRICA, S.L.  
Calle Miño 122 Naves E-F  
Polígono Industrial Santa Margarita  
08223 Terrassa (Barcelona)  
Tel. +34 900 993 625

**United Arab Emirates**

GE Industrial Solutions  
Injaz Building, 3rd Floor  
Dubai Internet City  
PO Box 11549, Dubai  
Tel. +971 4 4546912

**United Kingdom**

GE Industrial Solutions  
2 The Arena, Downshire Way  
Bracknell, Berkshire  
RG12 1PU  
Tel. +44 (0)800 587 1239



GE imagination at work