

# PDW30

Point-To-Point Wireless Bridge

**PRECISION  
DIGITAL**  
WIRELESS



**WIRELESS SYSTEM**

## FEATURES

- Signal Wire Replacement in a Rugged, Industrial Housing
- Inputs and Outputs on Both Field Units
- Simple to Order, Configure, & Install
- 1 Mile Line-of-Sight Outdoor, 500 Feet Indoor Range
- Inputs: Analog (4-20 mA, 0-10 V, 0-5 V, 1-5 V), Digital, and RS-485 Modbus® Communications
- Outputs: Analog (4-20 mA), Digital, and RS-485 Modbus® Communications
- Remote or Attached Antenna
- Repeaters and Directional Antennas Available
- Flanges for Wall or Pipe Mounting
- Software Available for Even Easier Setup
- NEMA 4X, IP68 Enclosure

**PRECISION DIGITAL CORPORATION**

**PRECISION  
DIGITAL**  
www.predig.com

# PDW30 Point-To-Point Wireless Bridge



## INTRODUCTION

The Precision Digital PDW30 gives you a simple, straightforward way to get an analog, discrete, or Modbus® signal from where you have it to where you need it. It's a point-to-point wireless bridge packaged in a rugged, weather tight housing designed to meet the demands of industrial installations.

The PDW30 is simple to order, simple to configure, and easy to trust with your application. Guaranteed ranges assure it will work with your application, or you can send it back - no questions asked. A wireless survey tool is available for those who may require a site survey for longer distances, making it easy to verify the installation will work the first time.

The PDW30 starts with an analog, discrete, or Modbus® input and wirelessly broadcasts it to a second PDW30 unit. The second unit then recreates that signal at its location. Just put the units in the field anywhere you have 12-24 VDC power.

Fixed or remote antenna modules are available, as well as a wide range of accessories including mounting kits, antenna-related accessories, and repeaters. The antenna may be directly attached or remotely located. High gain directional antennas are also offered.

## KEY FEATURES

### Signal Wire Replacement In a Rugged Industrial Area

The PWD30 wireless system is housed in a rugged, IP68, NEMA 4X painted aluminum enclosure and is a smart, economical choice when you need two devices to communicate over long distances in a harsh industrial environment. It eliminates the need to spend time and money on hard wiring your instrumentation throughout your facility.

### PDW30 Signal Range

The PDW30 has a range of 500 ft. indoors at industrial environments and an outside line-of-sight range of 1 mile. Any wireless network can be negatively affected by certain factors, such as physical obstacles and improper equipment placement. Check the installation guide and manual for tips on how to avoid common installation mistakes.

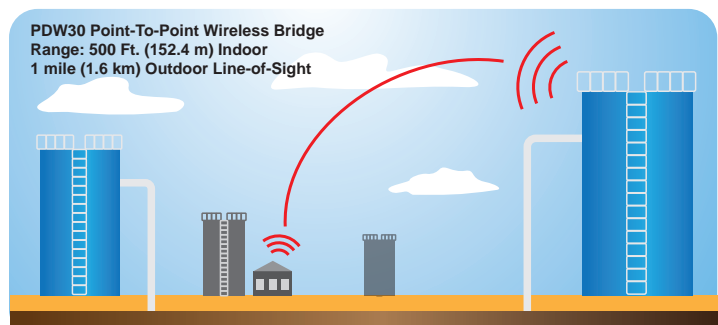

# PDW30 Point-To-Point Wireless Bridge

## Inputs and Outputs

The PDW30 wireless bridge units accept an analog input (4-20 mA, 0-10 V, 0-5 V, or 1-5 V), up to four discrete digital inputs, and RS-485 Modbus Communications. They also come with analog (4-20 mA), digital, and RS-485 Modbus outputs.

## PDW Manager Software for Even Easier Setup

The PDW30 is designed to be easy to setup, with just a few button pushes. However, the PDW Manager allows you to program the PDW30 wireless units from a PC with a USB connection. Units connect to a PC via the micro USB connection on their face, underneath the enclosure cover. Use of PDW Manager is required for programming advanced settings such as wireless encryption and analog signal calibration. PDW Manager can be found on the included CD or downloaded from [www.predig.com/PDWManager](http://www.predig.com/PDWManager). Once the software is running, power the unit using a 12-28 VDC power supply and connect the device to the PC using the provided USB cable.

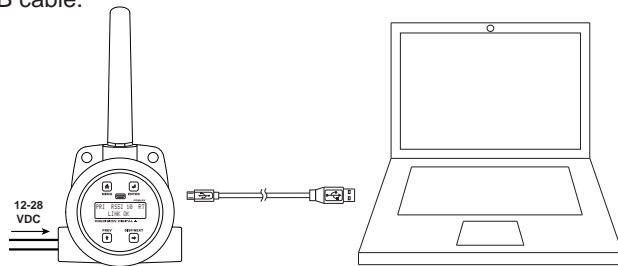

▲ Units connect to a PC via the micro USB connection

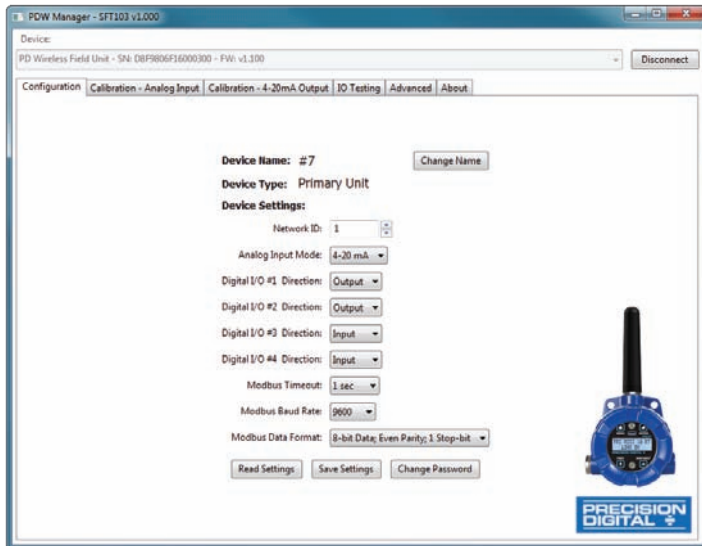

▲ Configuration Window of the PDW Manager Software

## Wall or Pipe Mounting

The PDW30 has flanges with two mounting holes that may be used for a 1.5" pipe mounting or wall mounting. Alternatively, the unit may be supported by the conduit using the conduit holes provided. It can also be mounted by using a mounting bracket in orient the device antenna away from the pipe. For best signal strength, do not mount the module on metal pipe with the antenna parallel to the pipe.

## NEMA 4X, IP68 Enclosure

The PDW30 units not only look great with their modern, smooth die cast aluminum enclosures, but they can be installed virtually anywhere. The NEMA 4X / IP68 rugged enclosure provides serious protection from the elements and harsh industrial environments.

## CONNECTIONS

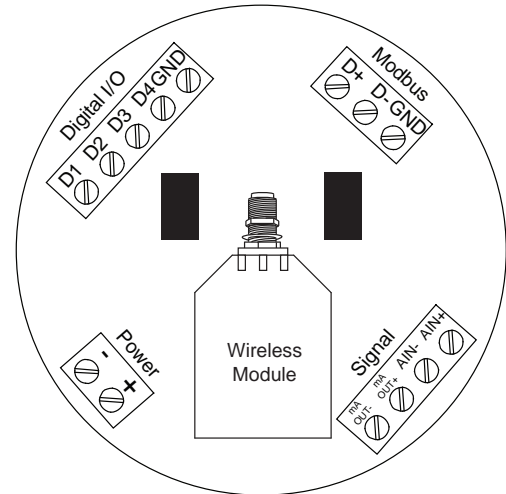

## Input Signal Connector

The analog input may be either 4-20 mA, 0-10 V, 0-5 V, or 1-5 V. The appropriate input type must be programmed for each unit.

## 4-20 mA Output Connector

The 4-20 mA output corresponds with the analog input signal on the paired wireless device. The analog output signal is always 4-20 mA, regardless of the analog input type on the other wireless module.

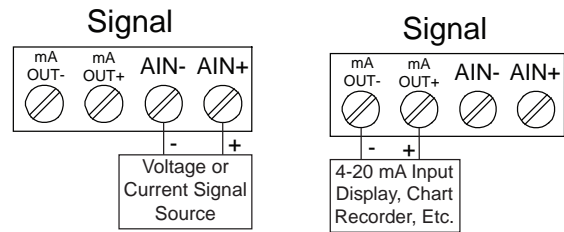

▲ Signal Connector

▲ 4-20 mA Output Connector

## Digital I/O Connector

All digital connections are referenced to ground. The primary unit digital I/O settings determine the settings of the secondary unit. (e.g. if DI of the primary is an input, DI of the secondary is an output)

**Note:** Each connection may be set independently in the device settings as either an input or an output. In the diagram to the right, D4 & D3 are digital inputs and D2 is a digital output.

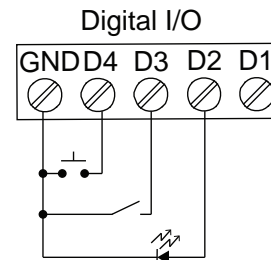

## Modbus RTU Serial Communications

The PDW30 acts as a simple pass-through for Modbus communications. As such, multiple Modbus enabled devices may be transmitted wirelessly using the PDW30 Wireless Bridge.

# PDW30 Point-To-Point Wireless Bridge

## SPECIFICATIONS

Except where noted all specifications apply to operation at +25°C.

### General

**Display:** 32-character dual-line alphanumeric dot matrix LCD display with backlight (4.68mm x 2.21mm characters)

**Display Orientation:** Display may be mounted at 180° from default orientation.

**Network ID:** Field selectable: 0 - 99

**Programming Methods:** Four programming buttons (behind glass) or PC with PDW Manager software.

**Recalibration:** All inputs and outputs are calibrated at the factory. Recalibration is recommended at least every 12 months.

**Process/Digital I/O Display:** Press the display button once to display the present analog input and output. Press the display button again to display digital I/O states.

**Password:** A programmable password restricts modification of program settings.

**Power:** 12-28 VDC, 5 W max

**Non-Volatile Memory:** All programmed settings are stored in non-volatile memory for a minimum of ten years if power is lost.

**Isolation:** 500 V

**Environmental:** *Operating temperature range:* -40 to 65°C (display inoperable < -20 °C); *Storage temperature range:* -40 to 85°C;

*Relative humidity:* 0 to 90% non-condensing

**Connections:** Removable screw terminal blocks accept 16 to 30 AWG wire.

**Enclosure:** Cast aluminum with glass window, 0.30% max copper content, corrosion resistant powder coating, color: blue. NEMA 4X/IP68. Three ½" NPT threaded conduit openings. One ½" NPT stainless steel conduit plug with 10 mm hex key fitting installed.

**Mounting:** May be mounted directly to conduit. Two mounting holes for 1.5" pipe or wall mounting. See manual for mounting space requirements.

**Signal Connector Tightening Torque:** 2.5 lb-in (0.28 Nm)

**Shipping Dimensions:** 17" x 14" x 9" (43.2 cm x 35.6 cm x 22.9 cm) (L x W X H)

**Shipping Weight:** 5 lbs. (2.27 kg)

**Warranty:** 3 years parts & labor

### Wireless Radio

**Frequency:** 900 MHz

**Range:** 500 ft (152.4 m) indoor,  
1 mi (1.61 km) outdoor (line-of-sight)

**Encryption:** AES 128-bit encryption available using PDW Manager software.

**Interference Reduction:** Frequency Hopping Spread Spectrum (FHSS)

**Power Output:** 24 dBm (250 mW)

**Sensitivity:** -101 dBm

**Antenna Cable Connection:** RP-SMA right angle male

### Analog Input

**Inputs:** *Field selectable:* 4-20 mA, 0-10 V, 0-5 V, 1-5 V

**Accuracy:** ±0.03% of calibrated span ±1 count

**Temperature Drift:** 0.005% of calibrated span/°C max from 0 to 65°C ambient, 0.01% of calibrated span/°C max from -40 to 0°C ambient

**Input Impedance:** *Voltage ranges:* greater than 500 kΩ;  
*Current ranges:* 50 - 100 Ω (depending on resettable fuse impedance)

**Signal Loss:** Inputs will remain off (open circuit) until wireless units are reconnected.

**HART Transparency:** Analog input will not interfere with existing HART communications on the wired 4-20 mA signal

### Isolated 4-20 mA Transmitter Output

**Output Source:** Analog input from connected wireless unit

**Calibration:** *Factory calibrated:* 4.000 to 20.000 = 4-20 mA output

**Accuracy:** ± 0.1% of span ± 0.004 mA

**Temperature Drift:** 0.4 µA/°C max from 0 to 65°C ambient,  
0.8 µA/°C max from -40 to 0°C ambient

*Note: Analog output drift is separate from input drift.*

**Signal Loss:** mA output will become 3.2 mA after approx. 25 seconds.

**Output Loop Resistance:**

Power Supply	Minimum	Maximum
24 VDC	10 Ω	900 Ω

### Digital Input / Output Terminal

**Channels:** Four (4) digital connections, independently field selectable as either inputs or outputs

**DI Logic High:** 3 to 5Vdc, TTL logic level

**DI Logic Low:** 0 to 1.1 VDC

**DO Logic High:** 3.1 to 3.3 VDC

**DO Logic Low:** 0 to 0.4 VDC

**Source Current:** 10 mA maximum output current

**Sink Current:** 1.5 mA minimum input current

**Signal Loss:** Digital output goes to logic high

*Note: A closed dry contact can be used for the digital inputs.*

### RS-485 Modbus® RTU Serial Comms

**Compatibility:** EIA-485

**Connectors:** Removable screw terminal connector

**Max Distance:** 3,937' (1,200 m) max

**Baud Rate:** 1200 – 57,600 bps

**Data:** 8 bit (1 start bit, 2 stop bits)

**Parity:** Even, Odd, or None with 2 stop bits

**Modbus Timeout:** 0.5, 1, 2, 3, 4, 5 seconds; user selectable

### PDW Manager Software

**System Requirements:** Microsoft® Windows® XP/Vista/7/8/10

**Communications:** USB 2.0 (Standard USB A to Micro USB B)

**Configuration:** Configure devices one at a time



# PDW30 Point-To-Point Wireless Bridge

## DIMENSIONS

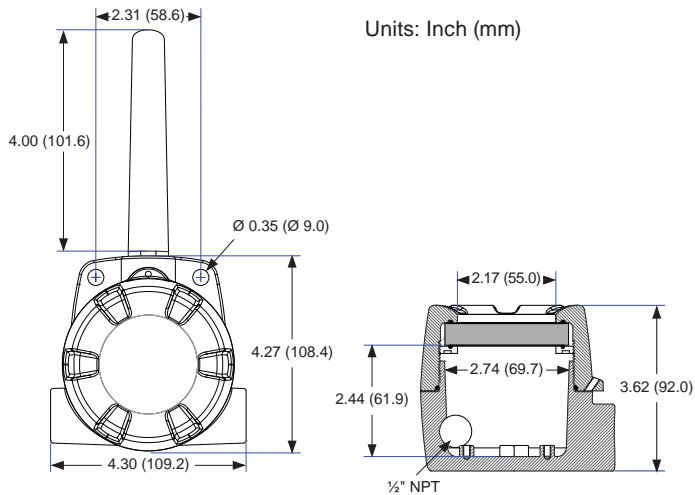

## APPLICATION EXAMPLE

This simple example demonstrates how the PDW30 may be used to wirelessly bridge an analog signal. Because the PDW30 can input and output a 4-20 mA signal, it is ideal for integration into existing 4-20 mA systems.

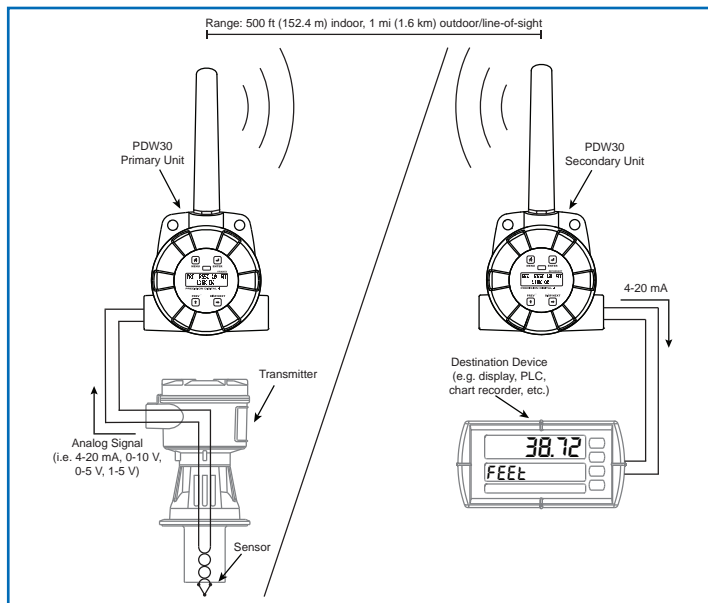

## ORDERING INFORMATION

PDW30 Point-to-Point Wireless System	
Model	Description
PDW30-SNA	PDW30 Point-to-Point Wireless System

Accessories	
Model	Description
PDA30-RNA	PDW30 Repeater Kit with Remote Antenna
PDA3900-12-N	Remote PDW30 1/2" NPT Antenna
PDA3900-6Y-N	Remote 6 dB Yagi High-Gain Directional Antenna
PDA3120-S	20' RP-SMA M/F Antenna Extension Cable with Fittings
PDA3140-S	40' RP-SMA M/F Antenna Extension Cable with Fittings
PDA3120-N	20' RP-SMA F to N Male Extension Cable with Fittings
PDA3140-N	40' RP-SMA F to N Male Extension Cable with Fittings
PDA6963	Stainless Steel PDW30 Mounting Kit
PDA10	PDW Wireless Signal Strength Survey Tool

Your Local Distributor is:

## Disclaimer

The information contained in this document is subject to change without notice. Precision Digital Corporation makes no representations or warranties with respect to the contents hereof, and specifically disclaims any implied warranties of merchantability or fitness for a particular purpose. ©2016-17 Precision Digital Corporation. All rights reserved.

LDSW30\_C 09/17