

ABB DRIVES

Drive Composer

Start-up and maintenance PC tool

User's manual

The screenshot displays the ABB Drive Composer software interface for an ACS880 drive. The interface includes a menu bar (File, Edit, View, Tools, Help), a toolbar with control buttons (LOC, REM, Start, Stop, Coast stop, Reference, Step), and a main parameter table. Below the table is an 'Online Monitor' section with a graph showing frequency ramp inputs over time.

Parameter Table:

Index	Name	Value	Unit	Min	Max	Default
1. Actual values						
3. Input references						
1	Panel reference	0.00	NoUnit	-10000...	100000...	0.00
2	Panel reference 2	0.00	NoUnit	-30000.00	30000.00	0.00
5	FB A reference 1	0.00	NoUnit	-10000...	100000...	0.00
6	FB A reference 2	0.00	NoUnit	-10000...	100000...	0.00
7	FB B reference 1	0.00	NoUnit	-10000...	100000...	0.00
8	FB B reference 2	0.00	NoUnit	-10000...	100000...	0.00
9	EFB reference 1	0.00	NoUnit	-30000.00	30000.00	0.00
10	EFB reference 2	0.00	NoUnit	-30000.00	30000.00	0.00
11	DDCS controller ref 1	0.00	NoUnit	-30000.00	30000.00	0.00
12	DDCS controller ref 2	0.00	NoUnit	-30000.00	30000.00	0.00
13	M/F or D2D ref1	0.00	NoUnit	-30000.00	30000.00	0.00
14	M/F or D2D ref2	0.00	NoUnit	-30000.00	30000.00	0.00
4. Warnings and faults						
5. Diagnostics						
6. Control and status words						

Online Monitor Table:

Name	Pen	Visible	Mask	Y-scale	Min	Max	y1	y2	y2-y1	x2-x1	f
{0}{0}Par 1.1 Motor speed used (rpm)	Red	<input type="checkbox"/>	FFFFFFF	<input type="checkbox"/>	-30000.00	30000.00	-	-	-	-	-3
{0}{0}Par 1.6 Output frequency (Hz)	Blue	<input type="checkbox"/>	FFFFFFF	<input type="checkbox"/>	-500.00	500.00	-	-	-	-	-v

The graph below the table shows two frequency ramp inputs over time. The left graph is for Par 1.1 (Motor speed) and the right graph is for Par 1.6 (Output frequency). Both graphs show a ramp up to a peak and then a ramp down. The scale for the left graph is 30 s and for the right graph is 5.2 y2.

List of related manuals

Drive firmware manuals and guides

Code (English)

Appropriate drive firmware manuals

Option manuals and guides

FENA-01/-11/-21 Ethernet adapter module user's manual	3AUA0000093568
FSO-12 safety functions module user's manual	3AXD50000015612
FSO-21 safety functions module user's manual	3AXD50000015614
FPBA-01 PROFIBUS DP adapter module user's manual	3AFE68573271

Tool manuals

ACX-AP-x assistant control panels user's manual	3AUA0000085685
Drive Composer start-up and maintenance PC tool user's manual	3AUA0000094606
Ethernet tool network for ACS880 drives application guide	3AUA0000125635
Adaptive programming application guide	3AXD50000028574

You can find manuals and other product documents in PDF format on the Internet. See section Document library on the Internet on the inside of the back cover.

User's manual

Drive Composer
Start-up and maintenance PC tool

Table of contents



Table of contents

1. Introduction to the manual

Purpose of the manual	11
Applicability	11
Compatibility	12
Target audience	12
Contents of this manual	13
Terms and abbreviations used in this manual	14

2. Overview of Drive Composer

Drive Composer PC tool overview	17
Supported features	18
Drive Composer entry Vs pro	19
System requirements	21
Drive Composer hardware requirements	21
Computer hardware requirements	21
Software requirements	21

3. Installation and uninstallation of Drive Composer

Determining the current Drive Composer version	24
Drive Composer update notification	24
Installing Drive Composer with the installer	25
Uninstalling Drive Composer with the installer	28
Registering Drive Composer pro	29
Registering Drive Composer pro	29

4. Connections

Using Assistant control panel drivers	31
Connecting to a drive with an Assistant control panel for the first time	32
Cable type	32
Connecting to drive with Assistant control panel	32
Changing the language settings	35
Connecting to a drive through an Ethernet network	37
Ethernet network connection	37
Creating an Ethernet network connection with Drive Composer (pro)	37
Configuring the TCP/IP address with Windows XP	38
Configuring the TCP/IP address with Windows 7	41
Connecting network drives (pro)	46
Panel bus network connection	46
Creating a panel bus with Drive Composer (pro)	46
Connecting to the panel bus with Drive Composer (pro)	47
Sharing connection (pro)	48

5. Main user interface components

Drive Composer UI overview	50
----------------------------------	----



Title bar	51
Closing the application	51
Alternate methods to close the application	51
Saving the workspace with unsaved changes	52
System menu	53
System menu commands description	53
Menu bar	54
Using the menu bar	54
File menu	54
File menu commands description	55
Edit menu	56
View menu	56
View menu commands description	57
Tools menu	58
Tools menu commands description	58
Help menu	60
Help menu commands	60
Drive control panel	61
Drive control panel buttons/items description	61
Using the drive control panel to start the drive	62
Drives list panel	63
Drives list panel: status indication	64
Working area	65
Using the working area	65

6. *Parameter window*

Parameter window overview	68
Parameter window command icons	69
Parameter window: view parameters	70
Parameters list representation	70
Navigating parameters and groups	71
Updating parameter values	71
Hidden parameters	71
Alternate formats to view parameters	71
Viewing bit names	72
Pointer parameters overview	74
Inverting a bit pointer	75
Setting fieldbus data in/out parameters	76
Binary parameters	78
Search for groups and parameters	79
Custom parameter window	80
Custom parameter window features	80
Saving custom parameter window	80
Viewing copied parameter values	81
Adding parameters to a custom parameter window	81
Working with offline files	84
Types of offline files	84
Saving parameters to a parameter file	84
Opening a parameter file (entry)	85
Opening an offline file containing parameter values (pro)	85
Downloading parameter values to a drive	85
Comparing drive data (pro)	86
User set functionality (Pro)	88

User set overview	88
User set system requirements	88
Limitations	88
Starting the user set function	89
Creating user set	91
Active and unsaved user set	91
Saving user set	92
Copying user set parameter values	92
Removing user set	93
Show/hide user set	94
User set parameters limitation	94
7. Monitor window	
Monitor window overview	95
Resizing the monitor window	96
Adding parameters/signals for monitoring	97
Monitor window components	98
Configuration and control settings	99
Monitor controls	101
Active signal area overview	101
Zooming the graph	102
Panning the graph	102
Legend area functions	103
Graph area functions	104
Double cursor tool	104
8. Workspace handling	
Workspace overview	105
Creating a custom parameter set and using it as a default workspace	106
9. Event logger	
Event logger view	109
Fault data logger	111
10. Diagnostics	
Support package	114
Creating a support package	114
Sending a support package to Drive Installed Base	114
Opening a support package (pro)	115
Drive application programming license	115
System info	116
Datalogger (pro)	116
Datalogger settings	118
Datalogger commands	118
Datalogger content configuration	118
Datalogger trigger configuration	120
Adding a trigger	120
Using the level triggers	121
Using bit mask trigger	121
Uploading triggered or stopped Datalogger data	121



Amplitude logger (pro)	123
Macro (pro)	124
Macro commands	126
Macro language	126
Simple example	126
Additional macro commands	127
Target	127
Target name	127
ParWrite	127
ParWriteInt	128
ParRead	129
ParReadInt	129
ParReadFromDevice	130
ParReadIntFromDevice	130
Wait	130
EndMacro	131
GotoMacro	131
MessageBox	131

11. Control diagrams (pro)

Control diagrams overview	133
Viewing control diagrams	134

12. FSO configuration (pro)

Configuring FSO-12 and FSO-21	137
Hardware connection	138
Setting the safety functions with Drive Composer pro	138
Printing the safety functions configuration report (Online)	146
Printing the safety functions configuration report (Offline)	150
Updating FSO firmware	151
Changing FSO module password	155
Reading FSO module parameters	157

13. Drive configuration

Loading firmware	160
Drive backup	165
Creating a backup of a drive	165
Creating a backup in drive parameter view	166
Creating quick parameter backup	167
Restoring a drive	168
Restoring a drive backup	168
Restoring a backup in the drive parameter view	169
Restoring a set of components/parameters settings (pro)	170

14. Other functions

Using Drive Installed Base service	174
Registering an ABB drive to Drive Installed Base service	174
Searching a registered ABB drive in Drive Installed Base	179
Setting the Drive Installed Base server location	181
Creating a service report from Drive Installed Base	182

Create online service report	183
Creating offline report	188
Recovery and prevention of FB14 fault in drive	190
FB14 Recovery pack	190
FB14 Service pack	191
Sending FB14 Service pack event	194
Sending offline FB14 Service pack event	194
FB14 Recovery and Service pack failure	194
Checking the status of Service pack	195
Using the Drive text editor	196
Using the Drive parameter conversion tool (pro)	199
Using the PSL2 data logger (pro)	202
Uploading PSL2 data logger files	202
Using the PSL2 data viewer (pro)	204
Viewing PSL2 data logger files	204
PSL2 Data Viewer instructions	204
Adaptive programming	206
Locking user interface	207
Lock state in System info page	207
Lock state in parameter view	207
Lock state in Backup/Restore page	208
Lock state in Safety settings page (pro)	209
Lock state in Drive text editor (pro)	210
RADIUS authentication	211
RADIUS authentication overview	211
RADIUS protocol overview	211
RADIUS authentication prerequisites	211
Configuring RADIUS authentication and offline credentials	212
Shared secret	213
Upload offline credentials	213
Activating RADIUS authentication function	213
Disable RADIUS authentication	214
Login with RADIUS authentication	214
Drive backup and restore	215

15. Annexure A: Creating Drive Installed Base service report template

Creating a template for Drive Installed Base service report (Internal use only)	218
Generic wizard step	219
Components	219
Common properties of components	220
ComboBox properties of components	220
DataGridView properties	221
DataBindings	223
DataSource	223
DataTarget	224
DataTarget objects	224
DataTarget examples	225
Saving the DC wizard template in StepDesigner	226
Deploying a template file	227
Localizing service report templates	227
Example:	227

16. Annexure B: Radius authentication

Example: Network configurations via Ethernet connection	230
ABB vendor specific attribute	231
Supported user access levels	231
Offline credentials	231
Default credentials:	231

17. Appendix: Error codes

Error codes	234
-------------------	-----

Further information



1

Introduction to the manual

Contents of this chapter

This chapter contains information on the applicability, compatibility, target audience and the purpose of the manual. It also describes the contents of the manual.

See topics:

<i>Purpose of the manual</i>	11
<i>Applicability</i>	11
<i>Compatibility</i>	12
<i>Target audience</i>	12
<i>Contents of this manual</i>	13
<i>Terms and abbreviations used in this manual</i>	14

Purpose of the manual

This manual describes the Drive Composer PC tool and instructs how to use it in the commissioning and maintenance of ABB drives.

Applicability

This manual applies to the Drive Composer PC tool, version 2.6 available in two different variants:

- Drive Composer entry, DCET-01
- Drive Composer pro, DCPT-01 (code: 3AUA0000108087).

You can download Drive Composer entry for free by navigating to www.abb.com/drives and selecting *Drive PC Tools*. Drive Composer pro includes all features and is available through ABB sales channels. Both versions require registration.

Note: In this manual, the features applicable only with Drive Composer pro are indicated as “(pro)”.

Compatibility

Drive Composer is a software tool for all ABB common architecture drives and devices. The tool supports following drive families:

ACSxxx	ACHxxx	ACQxxx	Others
ACS180	-	-	-
ACS380	-	-	-
ACS480	ACH480	-	-
ACS530	ACH531	ACQ531	-
ACS560	-	-	-
• ACS580 • ACS580MV	ACH580	ACQ580	-
ACS860	-	-	-
ACS880	-	-	• DCS880 • DCT880 • HES880
ACS6080	-	-	-

Drive Composer version	Compatible features
Drive Composer entry	<ul style="list-style-type: none"> • Offers basic features common to all compatible drives. • Connections to the drive with an Assistant control panel is common for all compatible drives and devices.
Drive Composer pro	<ul style="list-style-type: none"> • Offers a variety of features and software modules. The features and software modules are based on the drive type. • Recognizes the connected drive based on type code and firmware version and then adapts the availability of features accordingly. For example, if any of the feature is not applicable for the connected drive type, the Drive Composer UI does not display that particular module to the user. • For non-recognized, but compatible drives, the same common basic features are available than with Drive Composer entry. • <u>For ACS800 drives:</u> Has limited support (parameter editing and monitoring) and requires DriveWindow 2.40 installation on the same PC.

Target audience

The reader is expected to be an automation engineering professional or an electrician and familiar with drive products and the concepts regarding their commissioning and operation, including the parameter system of ABB drives. Also a basic knowledge of Microsoft Windows operating system is needed.

Contents of this manual

The manual consists of following chapters:

Chapter name	What it contains
<i>Introduction to the manual</i>	Provides information on the applicability, compatibility, target audience and the purpose of the manual.
<i>Overview of Drive Composer</i>	Lists the main features of the Drive Composer software and instructs how and where it can be run, and how to get help and additional information.
<i>Installation and uninstallation of Drive Composer</i>	Describes how to install and uninstall the Drive Composer software.
<i>Connections</i>	Describes how to make a connection with a drive through USB or Ethernet.
<i>Main user interface components</i>	Describes the main user interface components of the Drive Composer PC tool, including the menus.
<i>Parameter window</i>	Describes how to use the parameter window.
<i>Monitor window</i>	Describes how to use the monitor window.
<i>Workspace handling</i>	Describes the workspace functionality.
<i>Event logger</i>	Describes how to use the event logger.
<i>Diagnostics</i>	Describes how to troubleshoot a drive with the Support package button of Drive Composer and the data logger included in the drive.
<i>Control diagrams (pro)</i>	Describes how to use the control diagrams.
<i>FSO configuration (pro)</i>	Contains the configuration procedure of the FSO-12 and FSO-21 safety functions with Drive Composer pro and provides an example of how to configure the optional FSO-12 and FSO-21 safety functions module. It also explains how to update the FSO firmware version.
<i>Other functions</i>	Describes common functions that are not associated with any view or window. For example, instructions on creating backup of a drive, using the Drive parameter conversion tool, using the PSL2 data viewer, recovery and prevention of FB14 fault, and so on.
<i>Annexure A: Creating Drive Installed Base service report template</i>	Describes how to create a DIB service report template. Applicable for ABB internal users only.
<i>Annexure B: Radius authentication</i>	Includes additional information about Radius authentication feature, for example, network configurations via Ethernet, supported user access level, and offline credentials.

Terms and abbreviations used in this manual

Term or abbreviation	Explanation
Alarm limit of monitoring	You can set a low or high alarm limit for monitoring. Color(s) of the signal(s) change(s) on the monitoring graph area if the limit is reached.
Assistant	Provides predefined steps for setting the parameters of the drive. For example, the basic start-up assistant.
Assistant control panel	Control panel with an USB connector enabling a PC tool connection for common architecture drives. Assistant control panel is a generic name for ACS-AP-I and ACS-AP-S panels.
Autoscaling	Y-axis scaling is set automatically when this button is enabled. User-defined y-axis limits are then disabled. Note: Zooming is not possible in the Autoscaling mode.
Backup	Backup of the drive. Backup can be created with Drive Composer or with control panel*. The Drive Composer backup file (.dcp_paramsbak) includes all parameters, adaptive program and user sets. With a backup file from an old drive, you can quickly configure a new drive or restore configuration after firmware update. Note: Backup file does not include firmware, IEC program or license. * Refer to control panels user's manual.
Basic control panel	Control panel with limited basic functionality used with common architecture drives.
Bit mask of monitoring	You can filter bits of the Status word and monitor them individually.
BOL	Business Online. A common customer interface with electronic integration and order entry to all ABB business units.
Common architecture drives	For example, ACS880, DCS880, ACS580, ACH580, ACQ580, ACS560 and ACS480.
Compare parameters	You can compare parameters between drives or between a drive and a file to find out differences.
Control diagrams	Graphical presentation of the drive reference chain or other function. Shows online values of a parameter, switch positions and signals. Parameters can be modified online. Functionality is not available for all drives.
Copy/Download parameters	Visible parameters of a parameter window or custom parameter window are copied/downloaded to a drive.
Cursor tool	Monitor window has a double cursor tool and the positions of cursors can be freely set in the monitor window. $y_2 - y_1$ and $x_2 - x_1$ differences are calculated.
Custom parameter window	You can create windows and drag drop (copy) parameters to these windows. You can also change parameter values in the window and save the changes for using in offline mode. The Filename extension for custom parameters is *.dcustparams.
Data file viewer	In the Demo/Offline mode, the monitor window can be used as a data file viewer when saved monitored data (*.dcmn) or data logger data is analyzed.

Term or abbreviation	Explanation
Data logger	Signals are buffered inside a drive with a fast sample interval. Can be triggered and uploaded to the monitor window to be analyzed.
Demo/Offline	In Demo mode you can only view the default parameter values and settings in a pre-configured file. The FSO configuration file can be edited only in demo mode (for offline configuration). In Offline mode you can set/view the saved parameter files offline.
Drive Installed Base	Drive Installed Base (DIB) is a knowledge base containing information about drives. Drive Composer is the client application for Drive Installed Base service which is used to register a drive and to create service reports.
DriveAP	Adaptive Programming of a drive. Functionality of a drive can be modified by adding some IEC 61131 -based blocks. Adaptive Programming can be done also with an Assistant control panel. Note: Adaptive Programming is not available with all drives.
EDS	Electronic Data Sheet. EDS files are simple text files used by network configuration tools to identify products and describe the properties of these products and to commission them on a network.
Event logger	Consist of faults, alarms and events. Only faults stop the drive. Latest faults and all Electronic Data Sheet arms are also seen in the parameter interface group 4, <i>Warnings and Faults</i> .
FENA-11	Ethernet adapter module for ABB drives.
LOC/REM	LOC denotes local control of the drive, either with an Assistant control panel or with Drive Composer PC tool. REM denotes that drive is remotely controlled by the fieldbus master PLC or by I/O connections.
Lock/Unlock parameter	Parameter can be locked by a drive. You can only view the parameter values, but cannot modify them.
Macro script	User-written sequence of macro statements for reading and writing parameters/signals. Filename extension for macro scripts is *.p.
Monitoring	You can set parameters or signals to the monitor window. Values are collected with the sampling interval and drawn to a window.
NLS support	National Language Support, the user interface (UI) of Drive Composer can be easily modified by editing language files found in the LANG folder of the Drive Composer PC tool.
Online/Offline	In Online mode PC tool is connected with the drive. In Offline mode PC tool is not connected with the drive. In Offline mode it is possible to open parameter files, save monitored data, etc.
OPC server	OPC DA server interface for Drive Composer pro that allows other programs, such as Control Builder Pro (Advanced drive programming), to communicate with the drive.
Quick parameter backup	Backup of the drive parameters that are viewed, edited or expanded. When the drive parameter backup is slow, user has the option to perform a quick parameter backup or proceed with regular parameter backup.

Term or abbreviation	Explanation
RADIUS	Remote Authentication Dial-In User Service. RADIUS is an authentication protocol to manage access to the Internet or internal networks, wireless networks, and integrated e-mail services.
Refresh the parameter	Parameter values are updated when a group is opened. You can set parameters to the Auto-update mode or refresh the value manually. Signals are always updated automatically. In the parameter list, signals are shown in bold text.
Report	You can use report templates for energy savings, commissioning and maintenance. Templates can be modified.
Restore	You can restore the drive. You can select the parameters to be restored during the restore operation. For example, motor identification run results can be restored or deleted during the restore operation. Can be used for cloning drives.
Save parameters	Visible parameters of a parameter window or custom parameter window are saved to a file. Filename extension for saved parameters is <i>*.dparamsbak</i> . Note: Some values are not editable in the Offline mode.
Support diagnostics package	You can collect all data from a drive for troubleshooting purposes by clicking a button in Drive Composer or on an Assistant control panel.
Workspace	Workspace consists of the user interface status, such as parameters shown in the custom parameter window(s) and their status. You can save the current workspace status to a file and restore it later. Custom parameter windows with their contents and the monitor window contents (signals selected, scalings, colors) are saved to a workspace. You can set one default workspace. Filename extension for the workspace is <i>*.dcxml</i> .



2

Overview of Drive Composer

Contents of this chapter

This chapter briefly lists the main features of the Drive Composer software and instructs how and where it can be run, and how to get help and additional information.

See topics:

<i>Drive Composer PC tool overview</i>	17
<i>Supported features</i>	18
<i>Drive Composer entry Vs pro</i>	19
<i>System requirements</i>	21
<i>Drive Composer hardware requirements</i>	21
<i>Computer hardware requirements</i>	21
<i>Software requirements</i>	21

Drive Composer PC tool overview

Drive Composer is a 32-bit Windows application for commissioning and maintaining ABB common architecture drives.

The full version is called Drive Composer pro and the limited version is called Drive Composer entry. Both versions include a demo mode that allows you to test the user interface functionality, edit parameter files offline (pro) or open and analyze the saved or monitored files without connecting to a physical drive. You can edit the safety configuration file (with sanity check) only in demo mode for offline configuration.

Supported features

With Drive Composer, you can:

- control a drive: start, stop, direction, speed/torque/frequency reference
 - monitor the operation and status of a drive
 - view and adjust drive parameters
 - preview and add customized text to parameters
 - monitor signals in numerical and graphical (trending) format
 - work simultaneously with multiple drives like master and follower drives (pro)
 - display control diagrams of a drive for parameter setting and diagnostic purposes (pro)
 - create user-specific workspaces by customizing parameter windows
 - configure the optional FSO-12, FSO-21 safety functions module (pro)
 - handle workspaces
 - create and execute macro scripts (pro)
 - create and work with user set parameters (pro)
 - use Ethernet-based fieldbus adapter modules for PC tool communication (one-wire solution, Profinet, Ethernet IP) (pro) or a drive-embedded Ethernet port
 - use the USB port of an Assistant control panel for an USB connection
 - use an OPC-based commissioning and maintenance tool (pro)
 - connect to Drive Installed Base service portal and do following tasks: register a drive, search drive information, create service reports
 - recover drive from FB14 fault state
 - prevent FB14 fault
 - check the status of Service pack installation
 - limit access to certain operations of the drive with Radius authentication.
 - update FSO module firmware
 - update drive firmware
-

Drive Composer entry Vs pro

The table lists the features supported in the two versions of Drive Composer.

Feature	Drive Composer	
	entry	pro
Parameter window features		
Search/Modify/Print parameters	Yes	Yes
Parameters changed by user (or automatically updated) have an orange background	Yes	Yes
Save parameters to a file	Yes	Yes
Quick drive parameter backup	No	Yes
Copy/download parameters to a drive	Yes	Yes
Customize parameter windows	Yes	Yes
Edit parameters offline	No	Yes
Compare parameters between parameter lists or drives	No	Yes
Create and work with User set functionality	No	Yes
Diagnostics and monitor window features		
Collect data for support service using Support package icon	Yes	Yes
Monitor up to eight signals as a simple monitoring method for basic purposes	Yes	Yes
Monitor maximum 26 signals for professional analysis of a single drive or multidrive	No	Yes
Save the monitored data to the hard drive of a PC	Yes	Yes
Export monitored data to a PC using tab separated file	Yes	Yes
View contents of an event logger (faults, warnings)	Partly	Yes
View contents of System info (drive serial number, modules, versions, SW, etc.)	Yes	Yes
Restore or clone a drive using Backup/Restore feature	Yes	Yes
Restore a set of components/parameter settings using Advanced restore feature	No	Yes
Create a backup of complete multidrive with a single click using the Network Backup feature	No	Yes
Use PC to analyze data logged in a drive by a data logger	No	Yes
Create and execute macro scripts	No	Yes
Update drive firmware	No	Yes
Connections		
Connect network drives via Ethernet or with a panel bus	No	Yes
Connect point-to-point USB through a panel port	Yes	Yes

Feature	Drive Composer	
	entry	pro
Safety features		
Configure safety settings to a safety functions module (FSO)	No	Yes
Update FSO module firmware	No	Yes
Other features		
Use control diagrams of a drive for parameter setting and diagnostic purposes	No	Yes
User interface is available in different languages	Yes	Yes
Create and edit Adaptive programs	Yes	Yes
Support Virtual drive smart components	No	Yes
Connect to Drive Installed Base service portal to: register a drive, search for drive information, create service report	Yes	Yes
Recover drive from FB14 fault state	Yes	Yes
Recover and prevent FB14 fault without updating drive firmware	Yes	Yes
Check the status of Service pack installation	Yes	Yes
Configure RADIUS authentication	Yes	Yes
Add customized text to parameter with drive text editor	Yes	Yes
New Drive Composer version notification	Yes	Yes

System requirements

■ Drive Composer hardware requirements

Cable type	For...
USB type A (PC) type mini B (panel) cable Note: ABB recommends to use ferrite core cables.	connecting Drive Composer entry/pro through the USB port of the control panel to a drive (maximum 3 meters)
Ethernet cable RJ45	connecting through FENA-11 or embedded Ethernet

■ Computer hardware requirements

Hardware	Specification
Computer	IBM compatible PC
Processor	Intel i3 without virtual drive, Intel i5 with virtual drive
Memory	1GB without virtual drive, 8GB with virtual drive
Display	1024 x 600 display resolution with 256 colors
Hard disk	At least 4.5 GB free hard disk space
Storage	CD drive
Communication port	One free USB port or Ethernet port

■ Software requirements

Software	Specification
Operating system	Windows 7 and Windows 10 (32- or 64-bit)
Framework	.Net framework 4.8 or higher
Adobe Acrobat Reader	Not applicable

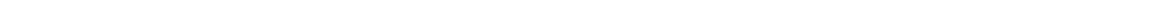

12

Installation and uninstallation of Drive Composer

Contents of this chapter

This chapter describes how to install and uninstall the Drive Composer software.

See topics:

<i>Determining the current Drive Composer version</i>	138
<i>Drive Composer update notification</i>	138
<i>Installing Drive Composer with the installer.</i>	139
<i>Uninstalling Drive Composer with the installer</i>	143
<i>Registering Drive Composer pro</i>	144
<i>Registering Drive Composer pro</i>	144

Determining the current Drive Composer version

To know the version of the Drive Composer PC tool, go to **Help** → **About the product**. The **About the product** dialog box displays the Drive Composer version.



Figure 1. About the product dialog box

Drive Composer update notification

If any new version of the Drive Composer is available, a **DRIVE COMPOSER UPDATES ARE AVAILABLE** dialog box appears. In the dialog box, you can click **HERE** and download the latest package file.

If you click **OK**, the dialog box appears again the next time you open Drive Composer. If you select the **Don't remind me again for this version** check box and click **OK**, the dialog box does not appear again.

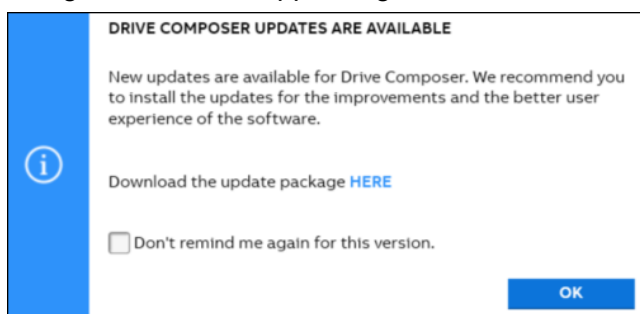

Figure 2. Drive Composer update

Installing Drive Composer with the installer

Note:

- ABB recommends to uninstall all previous versions of Drive Composer before you install a new version. See section [Uninstalling Drive Composer with the installer](#).
 - Close all applications before starting the installation.
1. Run the *setup.exe* file from the folder where you unzipped the Drive Composer files.
 2. With Windows 7, right-click on the *setup.exe* file and select **Run as administrator**.

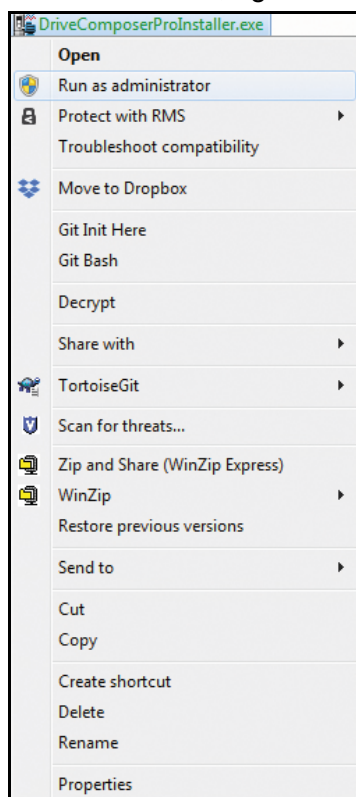

Figure 3. Installing Drive Composer: Run as administrator

3. In the **Drive Composer - Setup Wizard**, click **Next**.



Figure 4. Installing Drive Composer : Setup wizard window

4. Choose a destination folder and click **Next**.

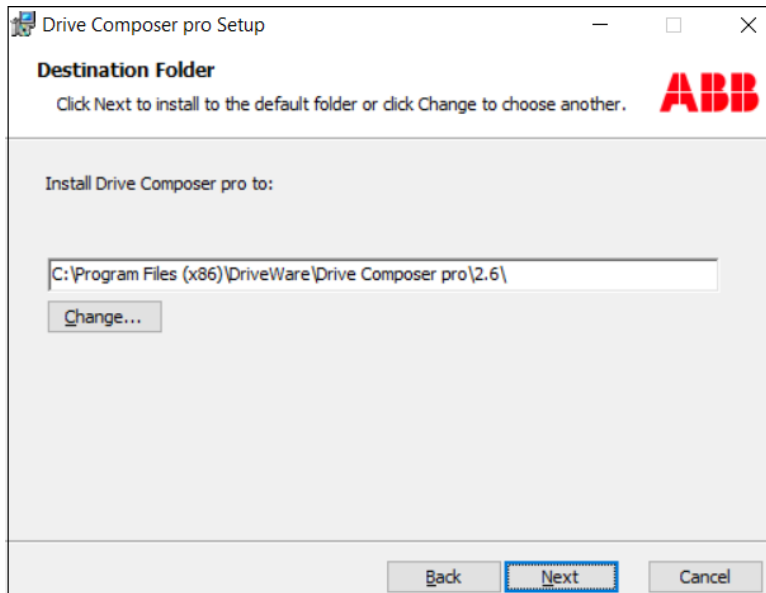

Figure 5. Installing Drive Composer: Destination folder window

5. Click **Install** to start the installation.

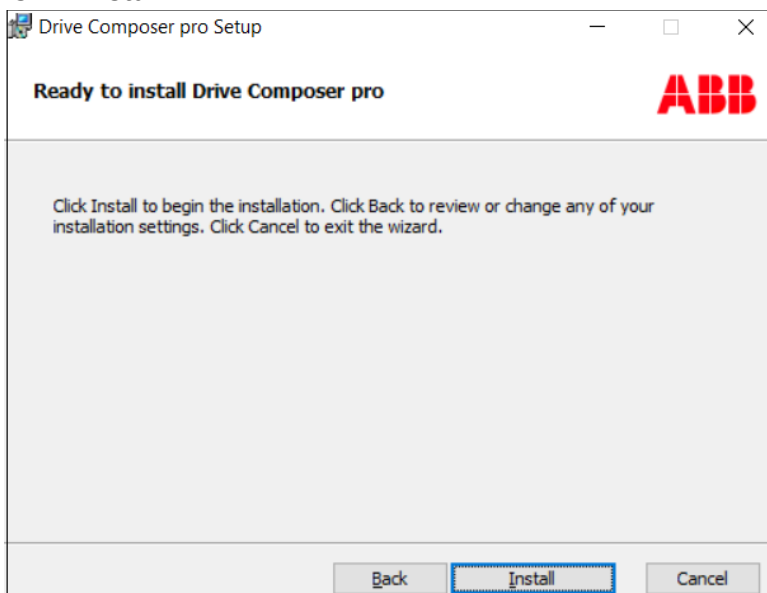

Figure 6. Installing Drive Composer: Install window

If Drive Composer installation is complete, click **Finish**. Now Drive Composer is ready for use.

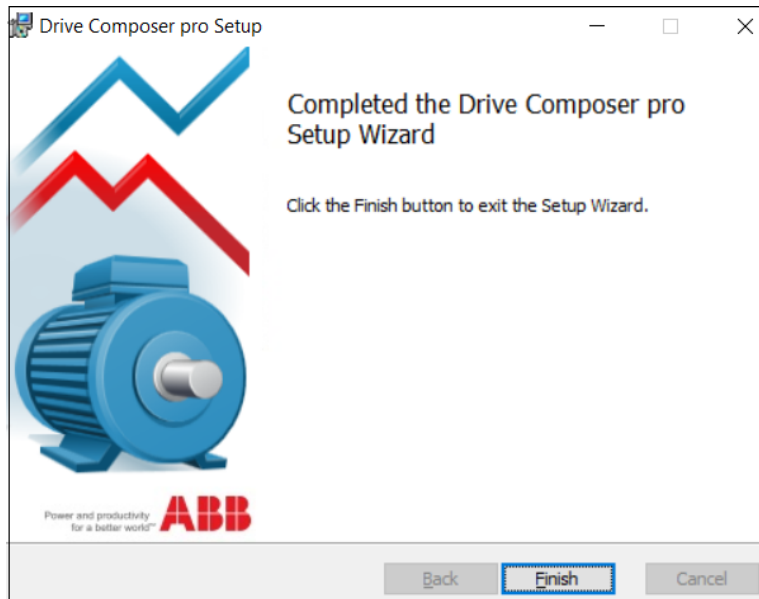

Figure 7. Installing Drive Composer: Installation completed window

On running the application for the first time, it displays a notification seeking permission to collect the tool's usage data to sent it to ABB. This is used for improving the performance and user experience. ABB does not collect any personal data. This is optional and is not mandatory to accept.

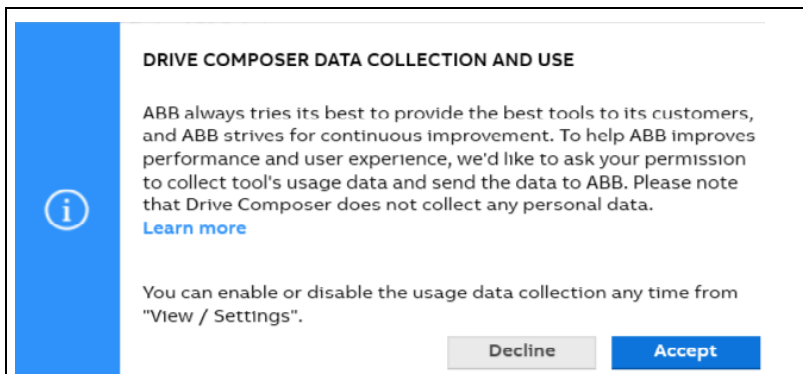

Figure 8. Installing Drive Composer: Data collection usage

You can enable or disable the usage data collection any time from **View** → **Settings**.

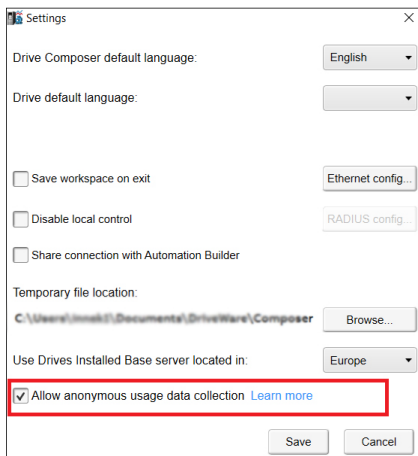

Figure 9. Installing Drive Composer: Data collection usage acceptance

Uninstalling Drive Composer with the installer

1. Go to **Control panel** → **Programs** → **Program and features** window and select the installed Drive Composer pro program. Click **Uninstall**.

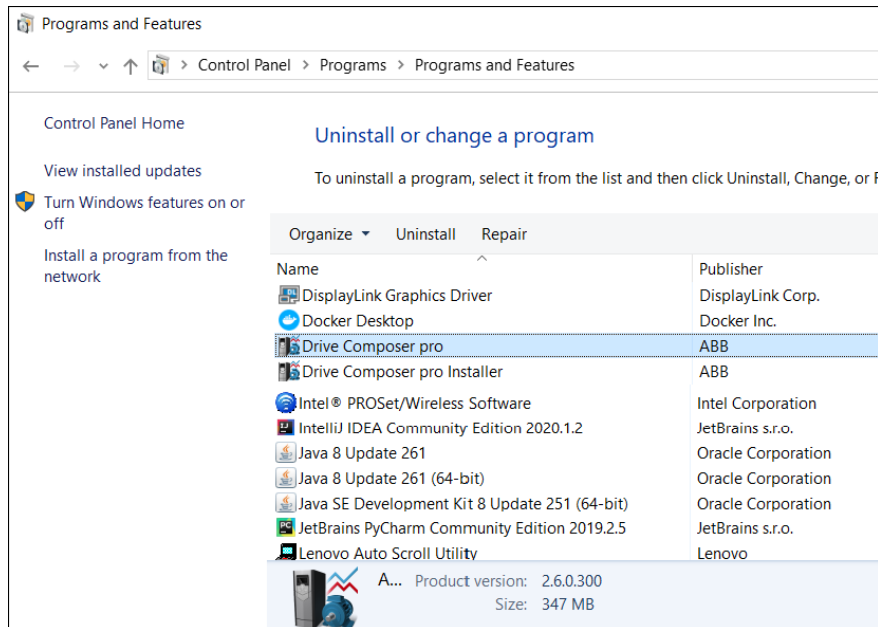

Figure 10. Uninstalling Drive Composer

2. Click **Yes** to uninstall Drive Composer pro application.

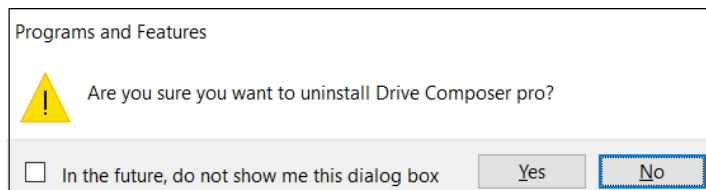

Figure 11. Uninstalling Drive Composer: Confirm removal of Drive Composer

Registering Drive Composer pro

Drive Composer pro includes a license and requires registration. During the first launch of the software, preferably you can register online. You can also make offline registration if Internet connection is not available on the PC where Drive Composer is installed.

You can also run Drive Composer pro for 30 days in fully functional evaluation mode.

■ Registering Drive Composer pro

During the first launch, Drive Composer pro prompts to enter the registration code or the license key. Fill in the registration code and click **Activate**.

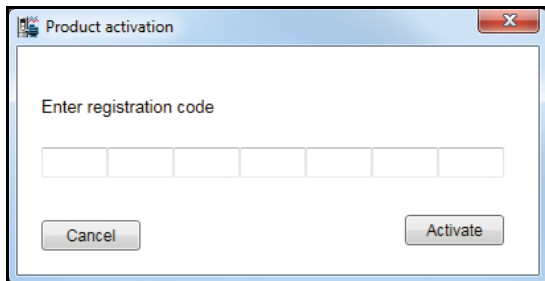

Figure 12. Register Drive Composer

You can also later at any time, enter the registration code or the license key. Go to **Help** → **Enter license code** and fill in the registration code and click **Activate**.



Connections

Contents of this chapter

This chapter describes how to make a USB connection or an Ethernet connection to an ABB drive with Drive Composer.

See topics:

<i>Using Assistant control panel drivers</i>	137
<i>Connecting to a drive with an Assistant control panel for the first time</i>	138
<i>Cable type</i>	138
<i>Connecting to drive with Assistant control panel</i>	138
<i>Changing the language settings</i>	141
<i>Connecting to a drive through an Ethernet network</i>	143
<i>Ethernet network connection</i>	143
<i>Creating an Ethernet network connection with Drive Composer (pro)</i>	143
<i>Connecting network drives (pro)</i>	152
<i>Panel bus network connection</i>	152
<i>Creating a panel bus with Drive Composer (pro)</i>	152
<i>Connecting to the panel bus with Drive Composer (pro)</i>	153
<i>Sharing connection (pro)</i>	154

Using Assistant control panel drivers

You can connect an ABB drive to an Assistant control panel (ACS-AP-x) through USB by installing the required USB device drivers. Drive Composer installer installs the required drivers automatically, so no user actions are needed.

If the installer failed to install the drivers automatically, you can manually install the USB drivers by downloading the tool from software tools website:

<http://new.abb.com/drives/software-tools/drive-composer>

Follow the instructions provided with the drive package.

Connecting to a drive with an Assistant control panel for the first time

■ Cable type

To establish a connection between Drive Composer and drive,

- connect a USB type A (PC) type mini B (panel) cable to the USB port of the computer and the USB port of the Assistant control panel (ACS-AP-x panel).
- use a USB cable of maximum length three meters.
- use separate USB/485 adapter if the drive is used without an Assistant control panel or with a Basic control panel.

■ Connecting to drive with Assistant control panel

1. Connect your PC to the Assistant control panel with a USB cable.

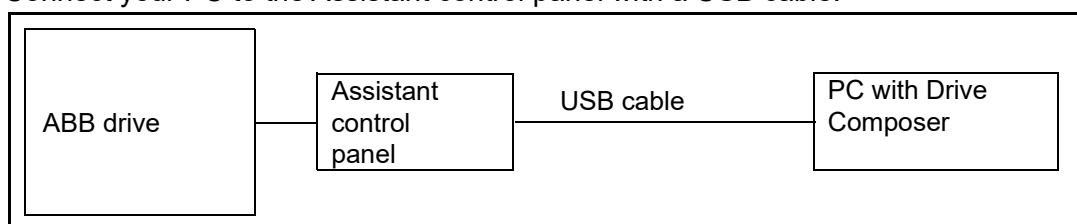

Figure 10. USB connection between Assistant control panel and PC

The following text appears on the Assistant control panel screen: “USB connected”.

Note: The Assistant control panel cannot be used when it is connected to a PC.

2. Launch Drive Composer by double-clicking **Drive Composer entry/pro.exe**.
3. Click **Connect** if you want to connect to the drive or click **Demo** if you want to choose the Offline mode.



Figure 11. Connecting to a drive: Connect/Demo button

You can also select the dedicated connections to the drive:

Connections	Description
DDCS enabled (ACS800 only)	Connects to the drive through DDCS (fiber optic) communication. This option is applicable only with ACS800 drive type.
USB/COM enabled	Connects to the drive through USB connection. Use this option only when you want to connect to the drive through serial connection, example, USB cable to the ACS-AP-x panel.
Ethernet enabled	Connects to the drive through Ethernet network.
Virtual drive enabled	Connects to the Virtual drive smart component. This option is applicable only when Virtual drive is installed in the PC.
Comm settings	Opens a dialog where you can configure the connections in more detail.

Note:

- The status LED starts flickering in the Assistant control panel to indicate data transfer between drive and PC. The LED keeps blinking as long as there is a PC tool connected to the drive. The welcome dialog box is shown on the screen indicating that the application is initialized.
- First time connection, parameter texts are loaded from the drive and this may take a few minutes depending on the drive type.

If Drive Composer is connected online with the drive, the drive parameters are loaded and following window displays.

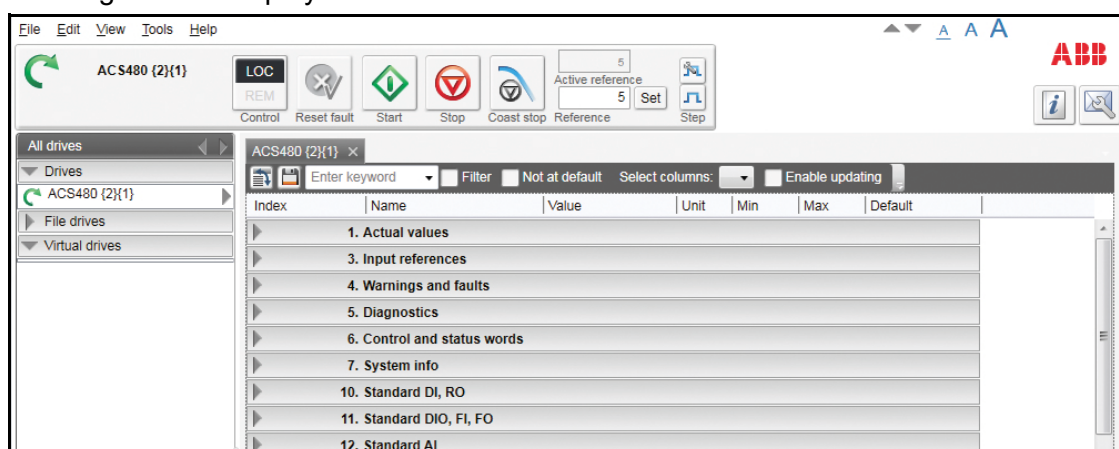

Figure 12. Connecting to a drive: Parameters loaded

If you have a single drive and a point-to-point connection, refer to chapter [Parameter window](#).

If Drive Composer failed to connect online with the drive, the Drive not found message appears. Make sure that all the instructions displayed in this window are satisfied.

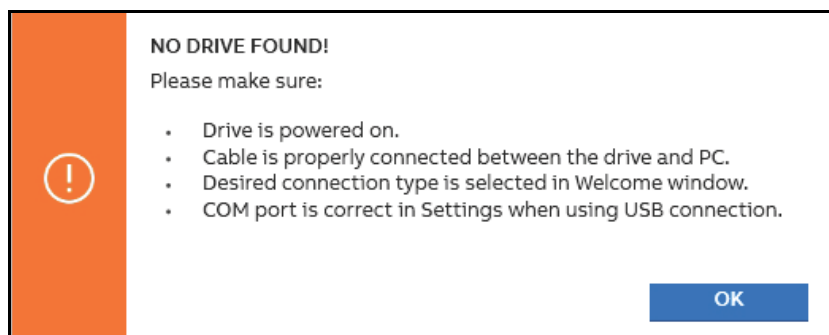

Figure 13. Drive not connected

4. Go to **View** → **Settings** to check your COM settings and click **View** → **Refresh** (Ctrl+R) to reconnect Drive Composer to the drive.

Changing the language settings

To change the language settings of the Drive Composer UI,

1. Go to **View** → **Settings**.

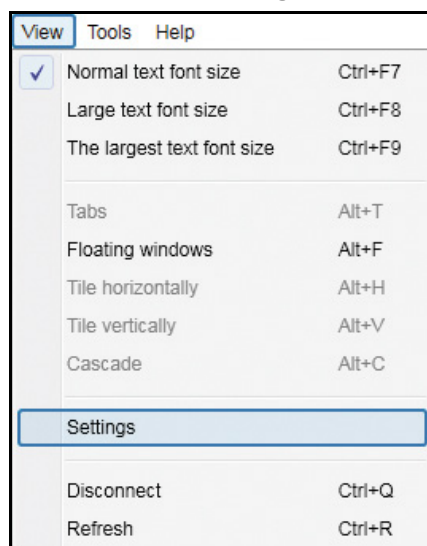

Figure 14. Changing language settings: View → Settings

2. In the **Settings** window, choose the required language for the Drive Composer UI.

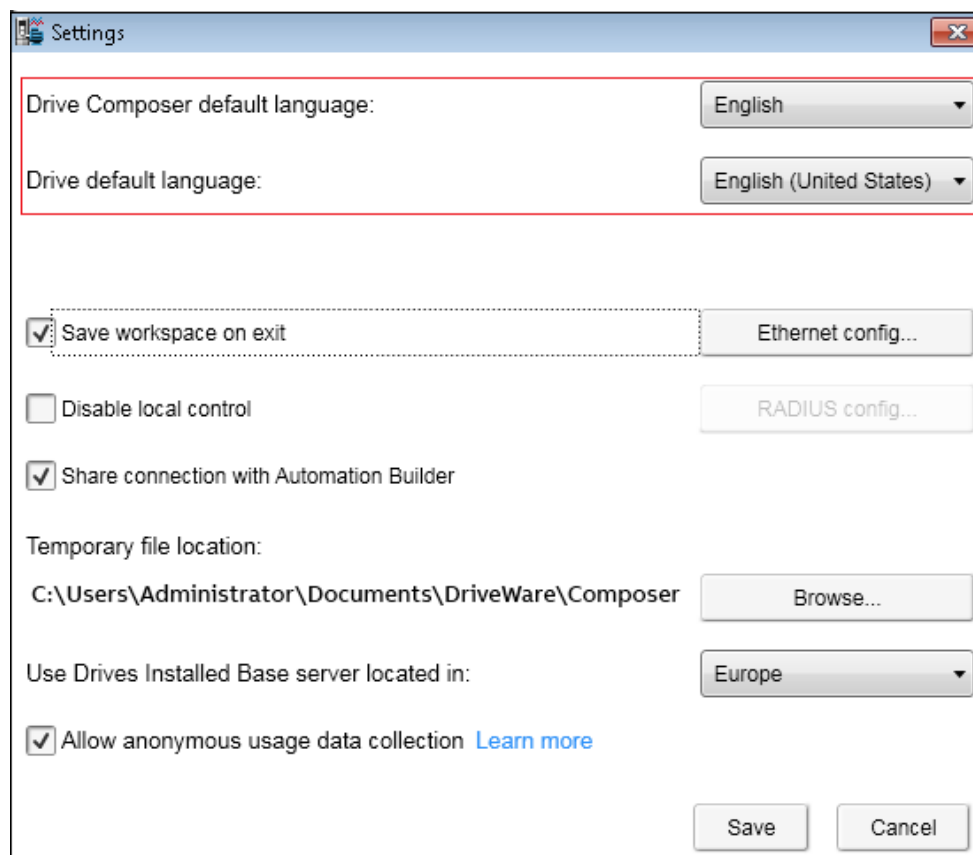

Figure 15. Language settings

- **Drive Composer default language**—selects the default language of the menu or button text in Drive Composer.
- **Drive default language**—selects the default language for parameters.

By changing language settings you can always use the same language when you connect Drive Composer to the drive.

3. After changing the language settings, click **View** → **Refresh (Ctrl + R)** or restart the Drive Composer application.

Note: Some elements might require application restart to update the selected language.

Connecting to a drive through an Ethernet network

■ Ethernet network connection

Some ABB drives have control boards with an embedded Ethernet port and some drives in which the Ethernet connection is made with the FENA Ethernet adapter module. For the installation of the adapter module, see *FENA-01/-11/-21 Ethernet adapter module user's manual* (3AUA0000093568 [English]).

Note: Configure the PC/Ethernet Switch firewall to allow a connection for Drive Composer pro (port http 80 and UDP), otherwise disable firewall.

■ Creating an Ethernet network connection with Drive Composer (pro)

1. Connect the FENA module to a drive.
2. Create a point-to-point connection from Assistant control panel or Drive Composer to each drive.
3. If you will use only one adapter module with the drive, enable FENA by setting parameter *50.01 FBA A enable* to *Enable* and parameter *50.21 FBA A Timelevel sel* to *Fast* (or *Monitoring* for Tool network only).
4. If you will use two fieldbus adapters with the drive and FENA is installed as FBA B, enable FENA by setting parameters *50.31 FBA B enable* to *Enable* and *50.51 FBA B Timelevel sel* to *Fast* (or *Monitoring* for Tool network only).
5. Set a static IP address for each drive. See *FENA-01/-11/-21 Ethernet adapter module user's manual* (3AUA0000093568 [English]).

51. FBA A settings						
1	FBA type	Ethernet	NoUnit			None
2	Protocol/Profile	MB/TCP ABB C	NoUnit			MB/TCP ABB C
3	Commrate	Auto	NoUnit			Auto
4	IP configuration	Static IP	NoUnit			Static IP
5	IP address 1	192	NoUnit	0	255	0
6	IP address 2	168	NoUnit	0	255	0
7	IP address 3	0	NoUnit	0	255	0
8	IP address 4	11	NoUnit	0	255	0
9	Subnet CIDR	24	NoUnit	0	32	0

Figure 16. Ethernet connection: IP settings of the drive with Drive Composer

6. Refresh the settings with parameter *51.27 FBA par refresh*.

Note: Refreshing the Node setting will lose the communication to the drive. To re-establish the connection with the drive, select **View** → **Refresh**.

- Name each drive to facilitate the recognition of drives when creating an Ethernet network connection.

In the **System info** tab, type the **Drive name** and click **Set**.

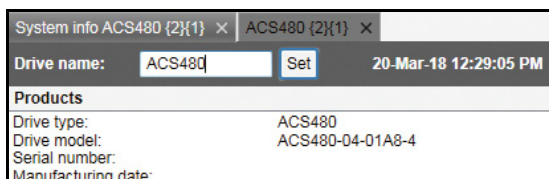

Figure 17. Ethernet connection: Naming a drive with Drive Composer

Note: The drive name changes only after you refreshed the view. The previous names in other existing workspaces are not affected.

If you use Assistant control panel, name the drive from the **Setting** menu of the panel.

- Configure the TCP/IP address of your PC. In this example the TCP/IP address is 192.168.0.1. For more information on configuring the TCP/IP address, see
 - [Configuring the TCP/IP address with Windows XP](#) or
 - [Configuring the TCP/IP address with Windows 7](#).

Configuring the TCP/IP address with Windows XP

- Go to **Control panel** → **Network and Internet Connections** → **Network Connections**.
- In the **Network Connections** window, double-click the required connection.

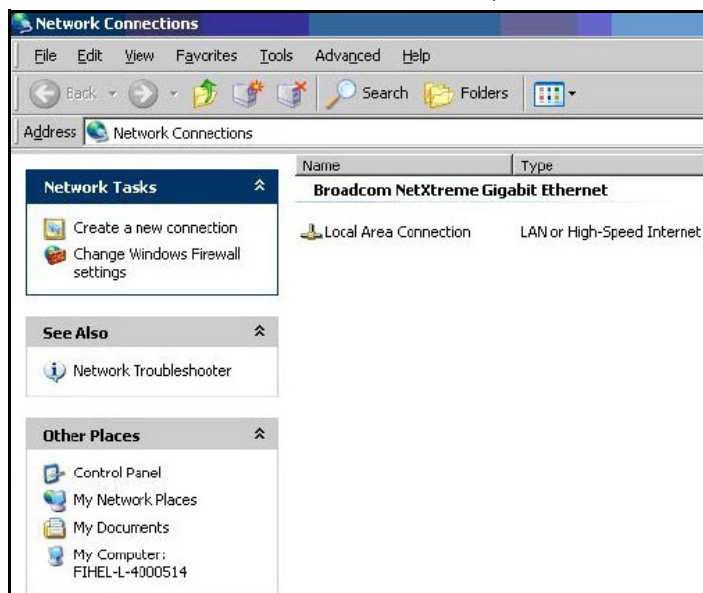

Figure 18. Configuring TCP/IP address: Network Connections window

3. Click the **Properties** button. The Local Area Connection Status dialog box appears.

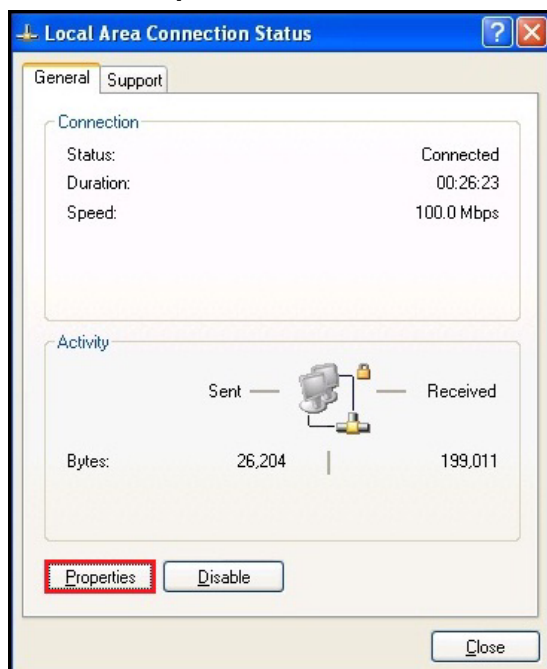

Figure 19. Configuring TCP/IP address: Local Area Connection Status

4. Select **Internet Protocol (TCP/IP)** and click **Properties**.

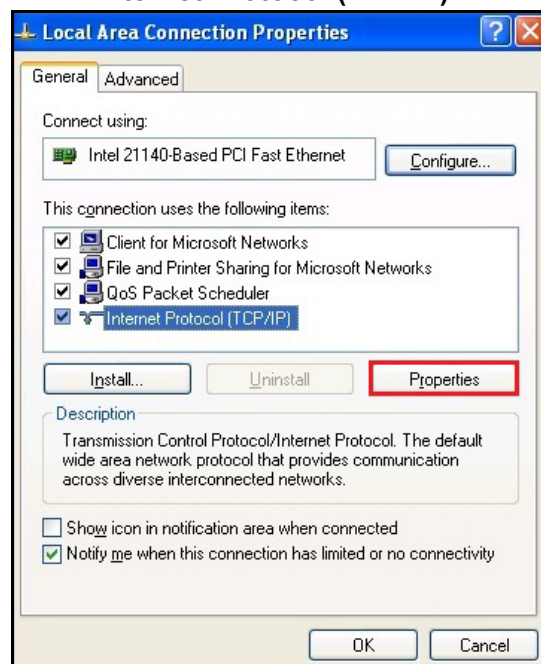

Figure 20. Configuring TCP/IP address: Local Area Connection Properties

5. Select **Use the following IP address** and type the IP address and the subnet mask. Click **OK**.

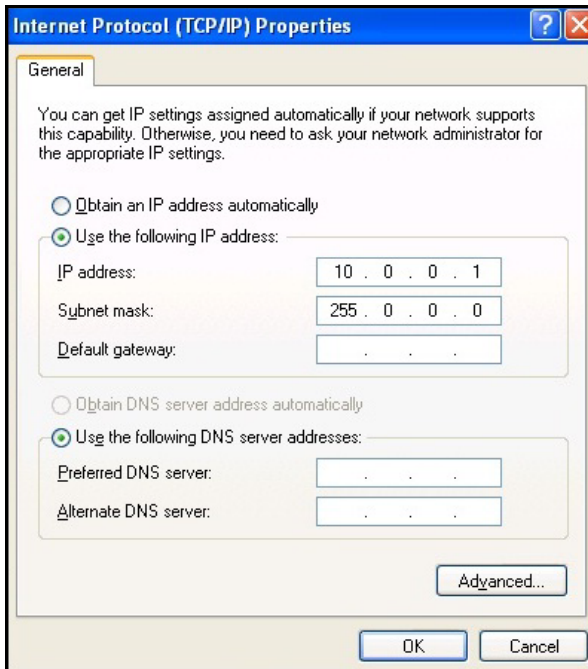

Figure 21. Configuring TCP/IP address: Use IP address

TCP/IP address configuration is completed.

Configuring the TCP/IP address with Windows 7

1. Go to **Control Panel** and click **View network status and tasks**.

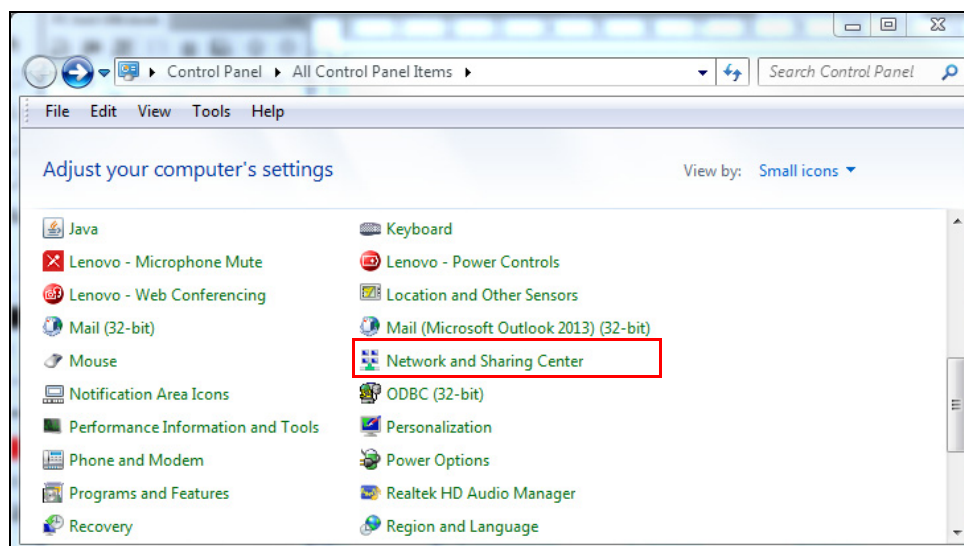

Figure 22. Configuring TCP/IP address: Win 7 Control Panel

2. Click **Change adapter settings** on the left pane. A Network connections window displays.

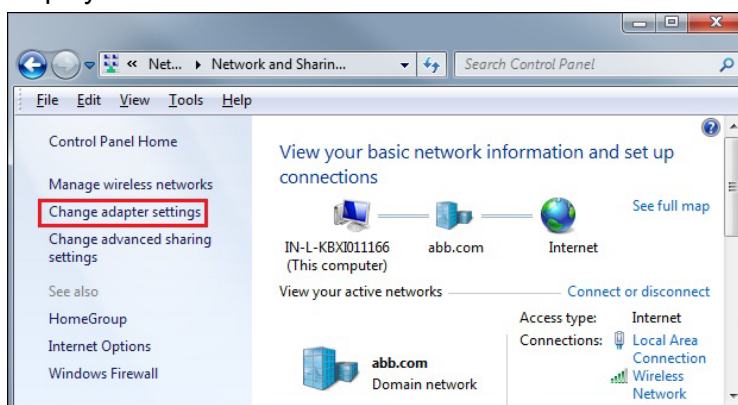

Figure 23. Configuring TCP/IP address (Win 7): Adapter settings

3. Double-click **Local Area Connection**.

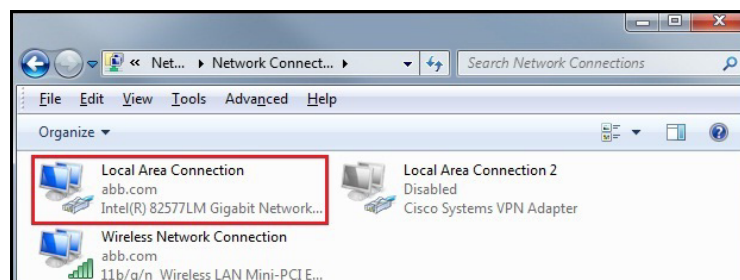

Figure 24. Configuring TCP/IP address (Win 7): Local Area Connection

4. Click **Properties**.

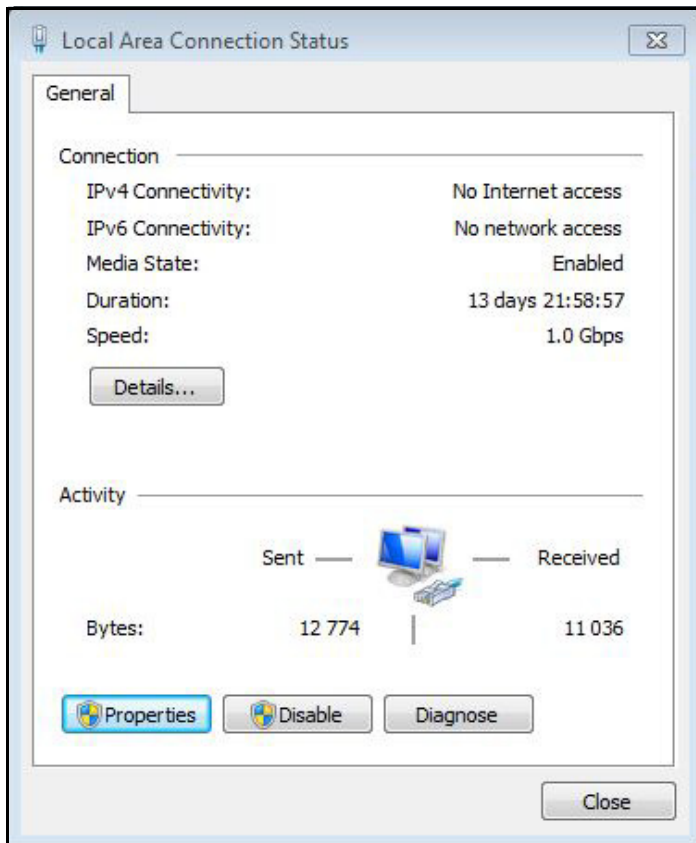

Figure 25. Configuring TCP/IP address (Wind 7): Local Area Connection Status

5. Select **Internet Protocol Version 4 (TCP/IPv4)** and click **Properties**.

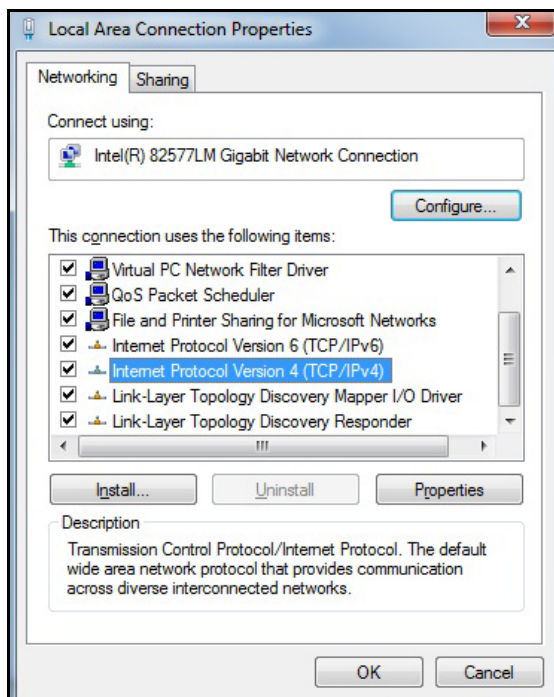

Figure 26. Configuring TCP/IP address (Win 7): Local Area Connection Properties

6. Select **Use the following IP address**, type the IP address and subnet mask and click **OK**.

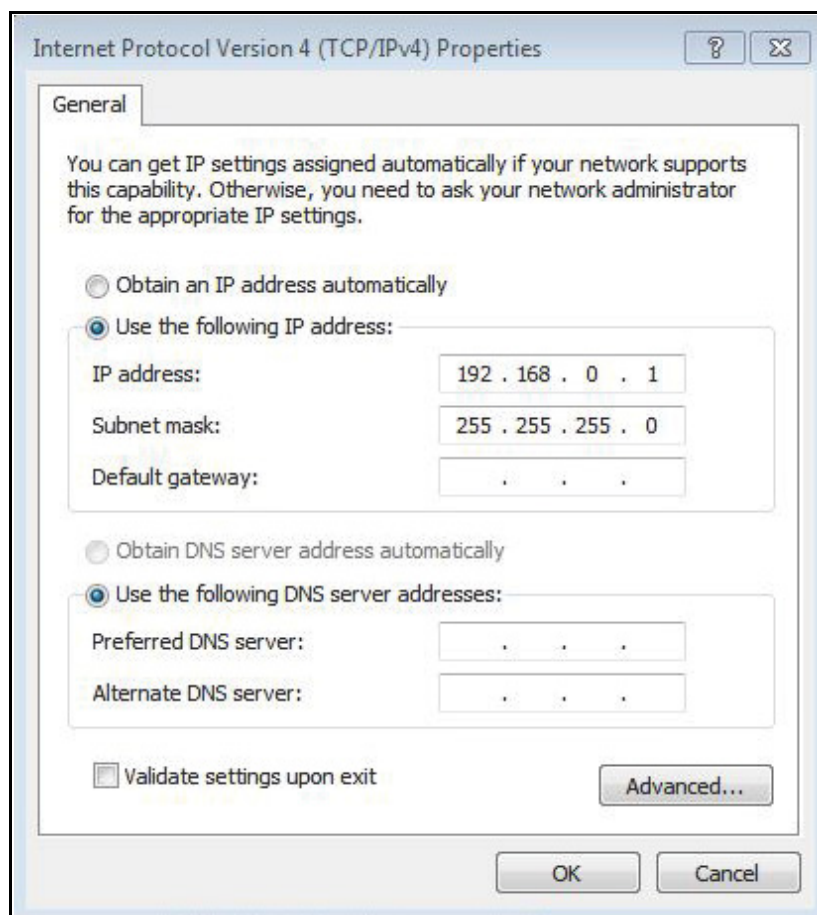

Figure 27. Configuring TCP/IP address (Win 7): Use IP address

7. Connect the RJ45 cable between the FENA module and PC. Alternatively, connect all drives and PC to the same Ethernet switch.

- Open command prompt (cmd.exe) and ping all the drives that you have configured.

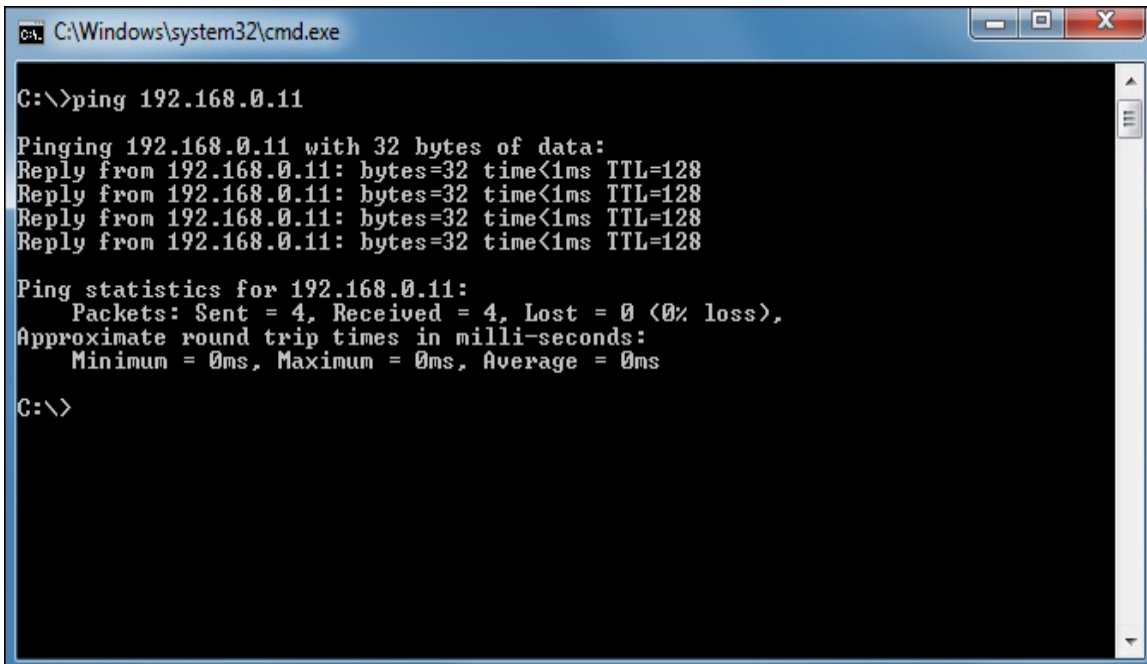

Figure 28. Configuring TCP/IP address (Win 7): Ping drives

Note: Open http port 80 of the firewall in your computer to enable Drive Composer pro to communicate with drives.

- Open Drive Composer pro. In the Welcome window, make sure **Ethernet enabled** is checked and click on **Comm settings** button.



Figure 29. Configuring TCP/IP address (Win 7): Ethernet enabled

10. In the Drive Ethernet Configuration Tool window, click **Scan** → **Scan Network**. Make sure **Auto configuration mode** is checked.

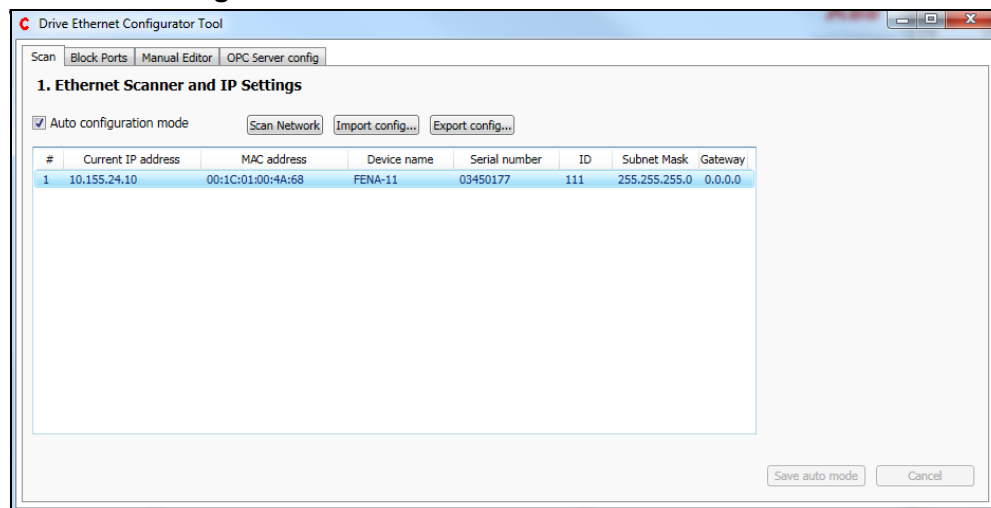

Figure 30. Configuring TCP/IP address (Win 7): Communication settings

Drive Composer scans all the COM ports and Ethernet ports to find drives.

If problems arise, see *Ethernet tool network for ACS880 drives application guide* (3AUA0000125635 [English]).

Connecting network drives (pro)

■ Panel bus network connection

You can connect all ABB drives with an ACS-AP-x panel using a daisy-chain connection through the control panel ports as a network either for a PC tool or a panel bus connection.

Note: Some ABB drives control boards (for example, ZCU-13) do not have any daisy-chain connectors. For those drives, a panel bus connection can be created with FDPI-02 option modules. See *FDPI-02 diagnostics and panel interface user's manual* (3AUA0000113618 [English]) for more information.



Figure 31. Connecting network drives: Creating a panel bus

■ Creating a panel bus with Drive Composer (pro)

1. Create a point-to-point connection from the Assistant control panel or Drive Composer to each drive.
2. Set an independent node ID for each drive (with parameter *49.01 Node ID number*). The node ID must be between 1...32.
3. Refresh the settings (with parameter *49.06 Refresh settings*).

Note: Refreshing the Node setting will lose the communication to the drive. To re-establish the connection with the drive, select **View** → **Refresh**.

4. With parameter *49.05 Communication loss action*, define how the drive reacts to a control panel (or PC tool) communication break by selecting **No action**.

49. Panel port communication						
1	Node ID number	<input type="text" value="5"/>	NoUnit	1	32	1
3	Baud rate	230.4 kbps	NoUnit			230.4 kbps
4	Communication loss time	10.0	s	0.1	3000.0	10.0
5	Communication loss action	No action	NoUnit			Fault
6	Refresh settings	Done	NoUnit			Done

Figure 32. Creating a panel bus: Panel port settings

5. Give a name for each drive to facilitate the recognition of drives when creating a panel bus connection.

In the System info tab, type the **Drive name** and click **Set**.

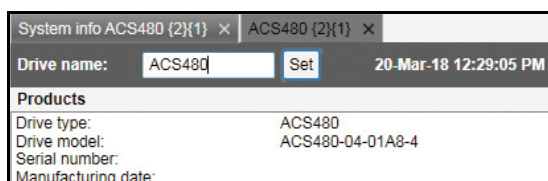

Figure 33. Creating a panel bus: Naming a drive

Note: The drive name changes only after you refreshed the view. The previous names in other existing workspaces are not affected.

If you used Assistant control panel, name the drives through the Setting menu of the panel.

6. Remove all panels connected to drives.
 7. For connecting the drives in a daisy-chain, connect a standard RJ45 (straight CAT5) cable on the left-hand side connector of the Assistant control panel in the first drive (the left-hand side drive in figure [Connecting network drives: Creating a panel bus](#) on page 152).
- Note:** Heavy-industry type RJ45 male connectors do not fit into the drive side female RJ45 slot
8. Connect a standard RJ45 (straight CAT5) cable from the right-hand side connector of the Assistant control panel in the first drive to the left-hand side connector of the Assistant control panel in the second drive.
 9. Continue chaining the rest of the drives as described above.
 10. If there is a long distance between the first and last drive in a panel bus, set the resistor to the ON position in the last node.

■ **Connecting to the panel bus with Drive Composer (pro)**

1. Connect a USB cable between the Assistant control panel and your PC.
2. Double-click **Drive Composer pro.exe** to launch Drive Composer.
The status LED starts flickering on the Assistant control panel.
3. Drive Composer starts scanning all selected networks and loads the connected drives.
4. Make sure you see all drives in the Drives list.

Notes:

- If you see a missing drive, close the PC tool and try again. If you still do not see all drives, check Group 49 Panel port communication for the settings of the missing drives.
 - Drive Composer does not automatically open any parameter window or other object.
5. Select and click a drive from the Drive list.

Sharing connection (pro)

1. Go to **View** → **Settings**.
2. In the **Settings** screen, select the option **Share connection with Automation Builder** to enable simultaneous connection to the same drive from both applications.

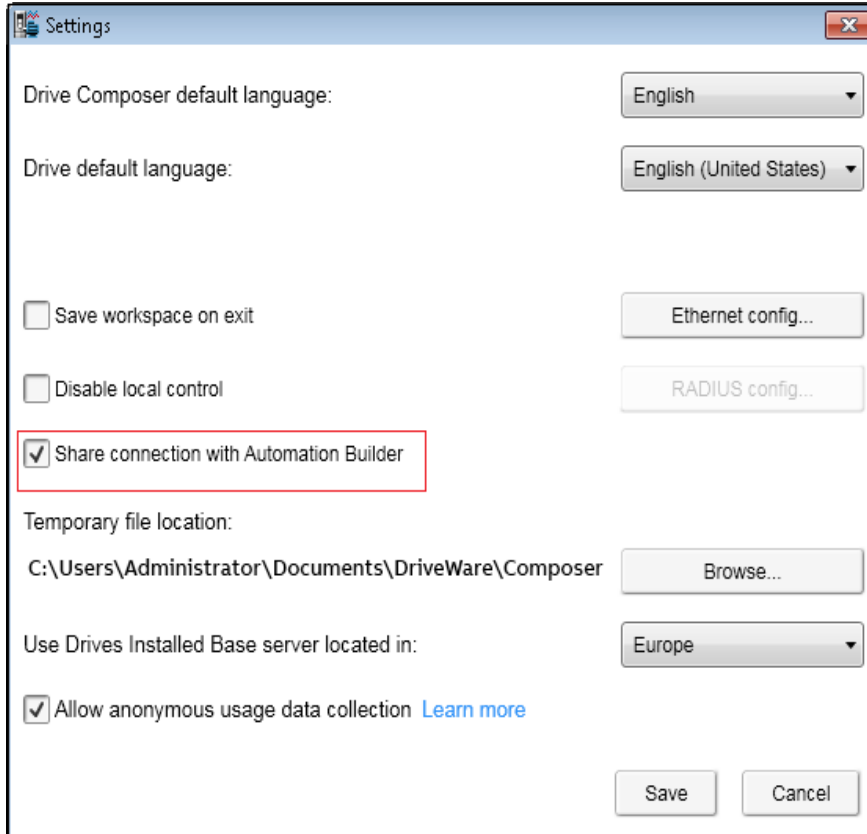

Figure 34. Connection sharing: Settings

3. Click **Save** to save the new settings.
4. You may be prompted to restart Drive Composer. Click **OK**, to restart.



12

Main user interface components

Contents of this chapter

This chapter describes the user interface (UI) components and how to use them.

See topics:

<i>Drive Composer UI overview</i>	138
<i>Title bar</i>	139
<i>Closing the application</i>	139
<i>Alternate methods to close the application</i>	139
<i>Saving the workspace with unsaved changes</i>	140
<i>System menu</i>	141
<i>Menu bar</i>	142
<i>Using the menu bar</i>	142
<i>File menu</i>	142
<i>Edit menu</i>	144
<i>View menu</i>	144
<i>Tools menu</i>	146
<i>Help menu</i>	148
<i>Drive control panel</i>	149
<i>Drive control panel buttons/items description</i>	149
<i>Using the drive control panel to start the drive</i>	150
<i>Drives list panel</i>	151
<i>Drives list panel: status indication</i>	152
<i>Working area</i>	153
<i>Using the working area</i>	153

Drive Composer UI overview

The Drive Composer user interface consists of the following parts.

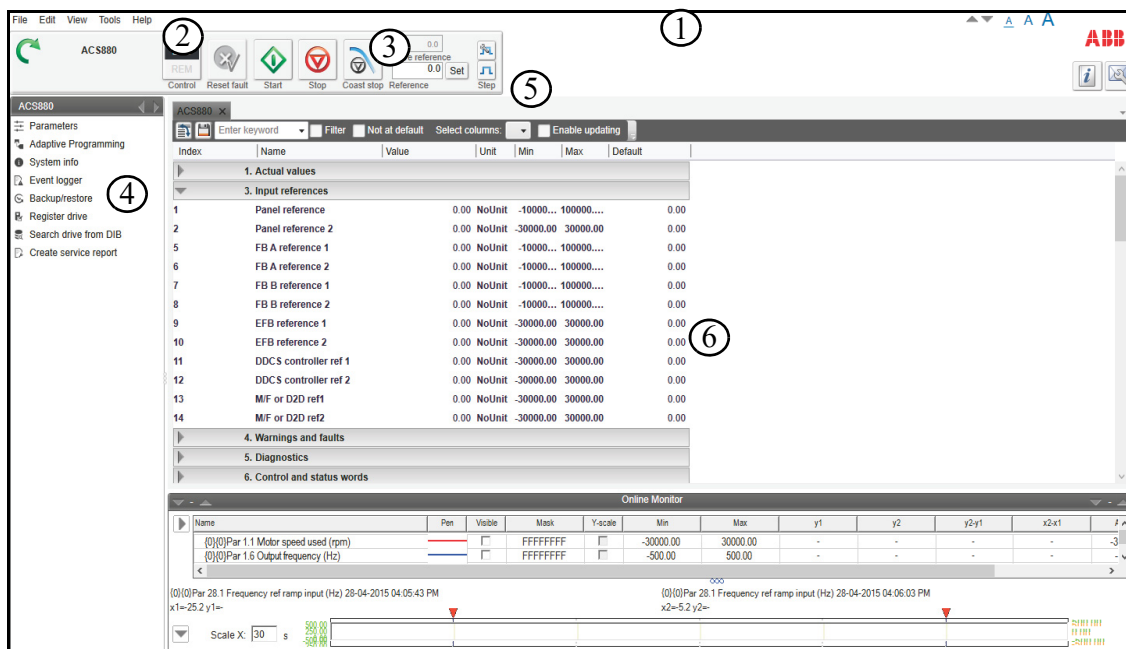
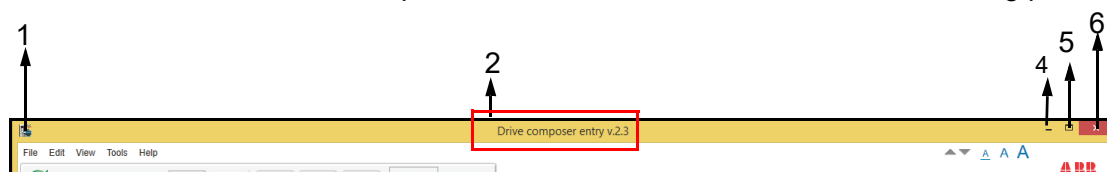

Figure 35. Overview of the user interface

1	Title bar
2	Menu bar
3	Drive control panel
4	Drives list panel (see also <i>Drives list panel: status indication</i>)
5	Status panel (including the output view of the selected drive).
6	Working area for parameter windows, event logger, control diagrams, assistants etc.

Title bar

The title bar is located at the top of the main window. It consists of the following parts:



1	System menu icon. See description in System menu .
2	Application name and version number (Drive Composer entry/pro)
3	Name of the workspace (if there is an active workspace)
4	Minimize button—has the same function as Minimize in the System menu. With this button, you can reduce the main window to the task bar or a sub-window to the bottom of the window area.
5	Maximize/Restore Down button (the name depends on the status of the maximized window)—has the same function as Maximize or Restore in the System menu. <ul style="list-style-type: none"> • With the Maximize button, you can enlarge the window to fill the available space. • With the Restore Down button or the Restore (from system menu), you can restore the window to the size and position it had before it was maximized. <p>Note:</p> <ul style="list-style-type: none"> • You can also maximize or restore the window by double-clicking the title bar. • You can move a window by dragging the title bar or you can move a dialog box by dragging its title bar. But you cannot move a window by dragging the title bar if you have maximized or minimized a window.
6	Close button—has the same function as Close in the System menu. With this button, you can end the Drive Composer session. See also description of Closing the application .

■ Closing the application

When you close the application, system prompts to confirm. Click **Ok** to close the application. Before closing, Drive Composer may:

- warn you about releasing control of the drive if the drive is controlled locally by Drive Composer
- prompt you to save the workspace with unsaved changes. See [Saving the workspace with unsaved changes](#).
- remind you to save your monitor data
- remind you of unfinished printing.

Note: If you disconnect the cable from the drive before closing Drive Composer there might be a long delay in operation.

■ Alternate methods to close the application

You can also close Drive Composer by

- double-clicking the **System menu** icon
- selecting **Close** in the System menu
- selecting **Exit** in the File menu
- pressing the shortcut key Alt+F4.

■ Saving the workspace with unsaved changes

You can close Drive Composer without saving the changes to workspace.

1. Go to **View** → **Settings**.
2. In the Settings window, check the option **Save workspace on exit**.

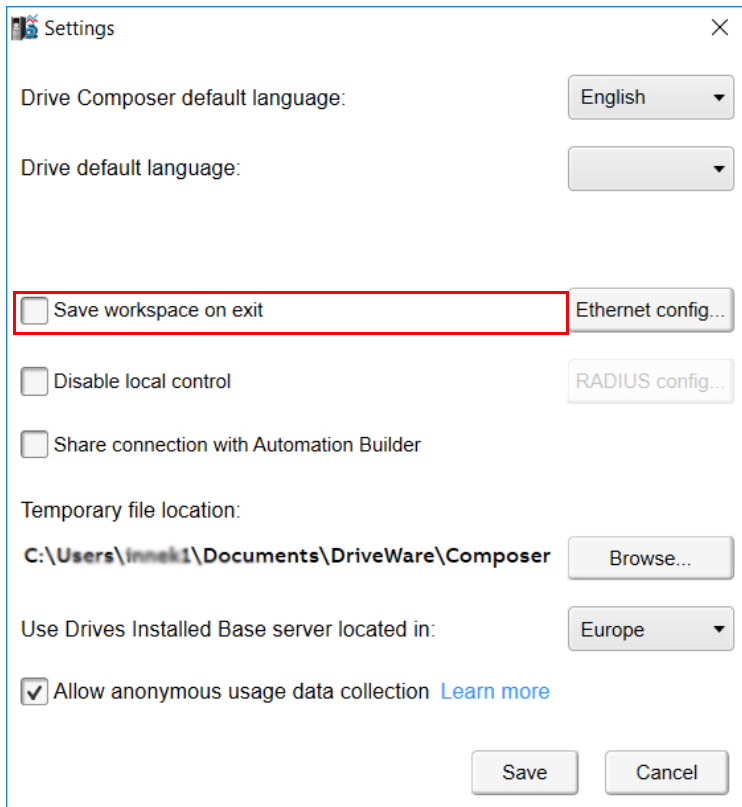



Figure 36. Save workspace on exit function

The function that prompts to save the workspace with unsaved changes is disabled.

■ System menu

You can open the System menu by

- left- or right-clicking the System menu icon 
- pressing the shortcut key Alt+space bar
- right-clicking within the non-button area of the title bar.

The System menu contains the following commands:

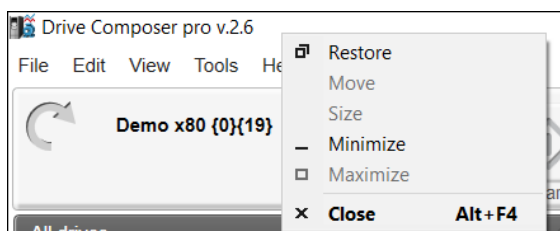

Figure 37. System menu

System menu commands description

Command	Description
Restore	Restores the window to its size and position which it had before it was maximized. This command is the same function as Maximize/Restore Down button in the title bar when the window is maximized.
Move	Allows moving the window with arrow keys. To stop moving the window, press ENTER. To cancel the move, press ESC. This function can also be performed by dragging the title bar.
Size	Allows resizing the window with arrow keys. To stop resizing the window, press ENTER. To cancel resizing, press ESC. This function can also be performed by dragging any of the sides or corners of the window.
Minimize	Reduces the window to the task bar or to the bottom of the window area. This command is the same function as the Minimize button in the title bar.
Maximize	Enlarges the window to fill the available space. This command is the same function as the Maximize button in the title bar when the window has not been maximized.
Close	Ends the Drive Composer session. This command is the same function as the Close button in the title bar.

Menu bar

The menu bar is located below the title bar. It contains the following drop-down main menus:

- File
- Edit
- View
- Tools
- Help.

■ Using the menu bar

- Click on a menu name to execute a command
- Use arrow keys to navigate between the menus
- Press ENTER to execute a highlighted command
- Press ESC, to close a menu
- Use also shortcut keys to execute the commands.

■ File menu

The File menu is always located in the menu bar. See description in [File menu commands description](#).

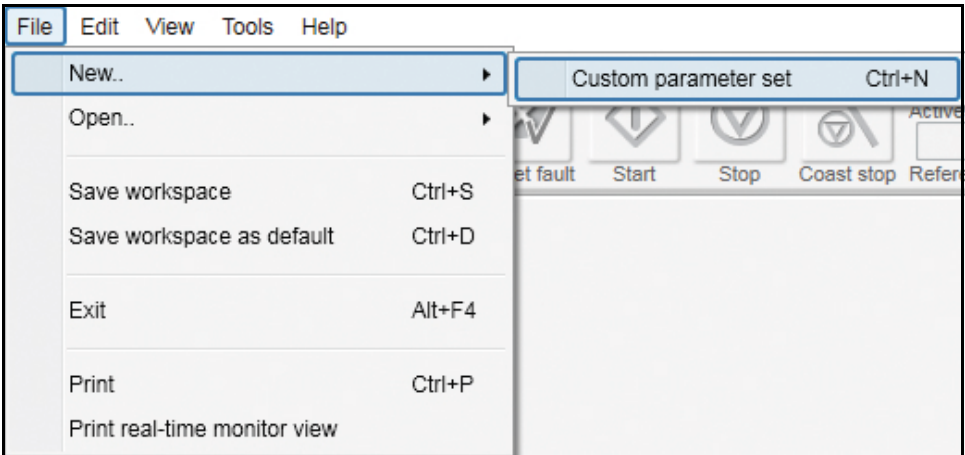

Figure 38. File menu → New

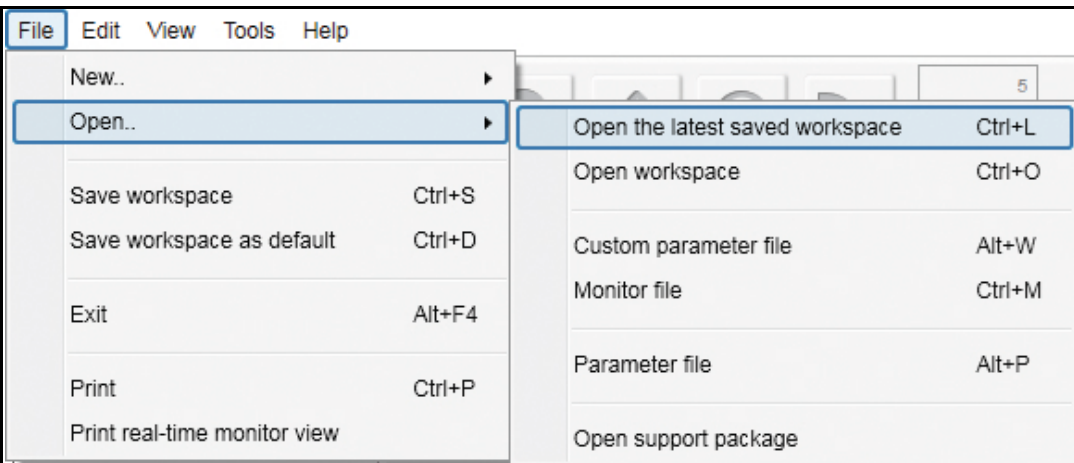

Figure 39. File menu → Open

File menu commands description

Command	Sub-command	Description	Keyboard shortcut
New..	Custom parameter set	Creates a new parameter set window. You can also set this window as the default.	Ctrl+N
Open..	Open the latest saved workspace	Opens the latest saved workspace.	Ctrl+L
	Open Workspace	Opens a new window where you can select the saved workspace to be opened.	Ctrl+O
	Custom parameter file	Opens a new window where you can open the saved custom parameter file.	Alt+W
	Monitor file	Opens a window to open the parameter file for monitoring.	Ctrl+M
	Parameter file	Opens a new window where you can select the saved parameter file to be opened.	Alt+P
	Open support package	Opens a new window where you can select the saved support package file to be opened.	-
Save workspace	-	Saves the active workspace of a file.	Ctrl+S
Save workspace as default	-	Saves the active workspace to default workspace. The default workspace opens automatically when Drive Composer is opened.	Ctrl+D
Exit	-	Ends the Drive Composer session.	Alt+F4
Print	-	Prints the parameter screen.	Ctrl+P
Print real-time monitor view (pro)	-	Prints the monitor screen.	-

■ Edit menu

The Edit menu is always located in the menu bar.

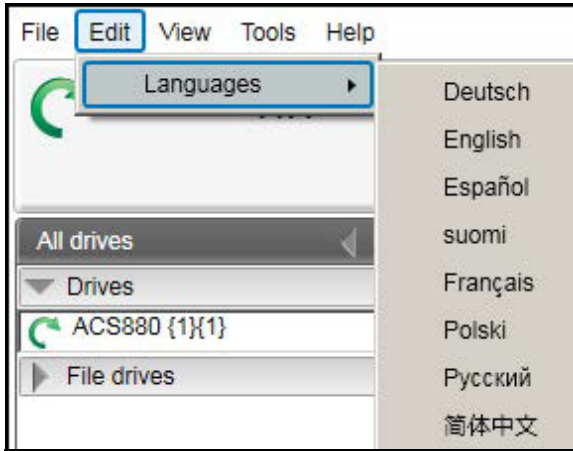

Figure 40. Edit menu

The menu contains the language commands with which you can select the language for the Drive Composer user interface.

Note: Restart the Drive Composer to see the language changes.

■ View menu

The View menu is always located in the menu bar.

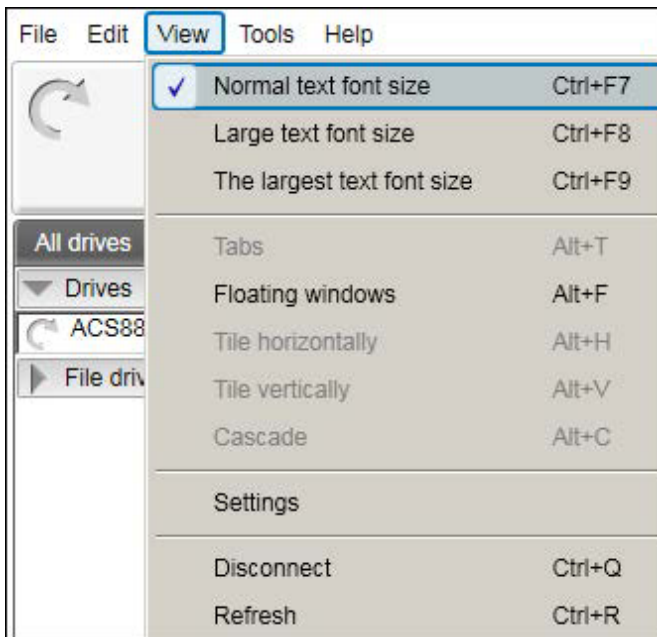



Figure 41. View menu

View menu commands description

Command	Description	Keyboard shortcut
Normal text font size	Selects normal font size. Note: The change in the font size does not affect the size of the monitor window font.	Ctrl+F7
Large text font size	Selects larger font size.	Ctrl+F8
The largest text font size	Selects the largest font size. You can also change the font sizes using the following A-letter icons. 	Ctrl+F9
Tabs	Changes working area to be viewed as tabs. Note: The monitor window cannot be tabbed.	Alt+T
Floating windows	Changes working area to a separate window. Note: The monitor window cannot be a floating window.	Alt+F
Tile horizontally	Changes floating windows to be tiled horizontally.	Alt+H
Tile vertically	Changes floating windows to be tiled vertically.	Alt+V
Cascade	Changes floating windows to cascade. You can resize and freely locate the cascaded windows in the working area.	Alt+C
Settings	Defines language and connection configuration. Enables to <ul style="list-style-type: none"> • save workspace settings • disable local control • share connection to the same drive Allows to <ul style="list-style-type: none"> • select temporary file location • set the appropriate Drive Installed Base server location. 	-
Disconnect	Disconnects Drive Composer from the drive.	Ctrl+Q
Refresh	Creates a new connection between Drive Composer and the drive, which means, uploading parameter information from a single drive and creating a new connection with multidrives.	Ctrl+R

Tools menu

The Tools menu is located in the menu bar. The commands of the Tools menu may vary between different software versions and drives.

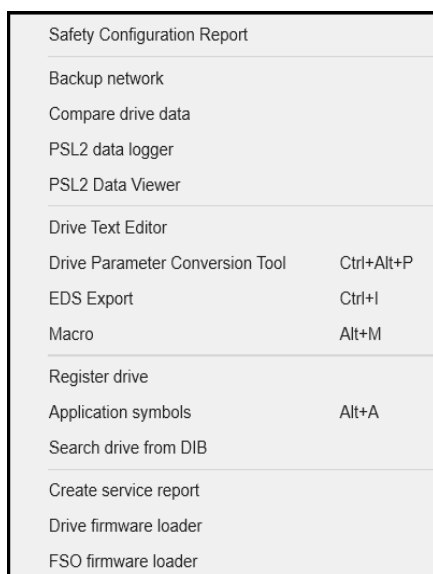

Figure 42. Tools menu

Tools menu commands description

Command	Description	Keyboard shortcut
Safety Configuration Report (pro)	Prints safety functions configuration report if FSO module is installed.	-
Backup network (pro)	Creates backup of all connected drives in a PC tool network.	-
Compare drive data (pro)	Compares parameters of two drives or a parameter file and a drive or two parameter files.	-
PSL2 data logger (pro)	Uploads PSL2 data logger files from the drive flash memory to PC local hard drive. This option is applicable only in BCU-x2 control unit. See Using the PSL2 data logger (pro) on page 202.	-
PSL2 Data Viewer (pro)	Opens and views contents of the uploaded PSL2 data logger files in the PC local hard drive. See Using the PSL2 data viewer (pro) on page 204.	-
Drive Text Editor (pro)	Allows reading texts from the drive to make changes and to update texts to the drive. See Using the Drive text editor on page 196.	-
Drive Parameter Conversion Tool (pro)	Converts parameters. See Using the Drive parameter conversion tool (pro) on page 199.	Ctrl+Alt+P
EDS Export (pro)	Creates EDS files of a connected drive.	Ctrl+I
Application symbols (pro)	Shows symbols exported from Control Builder Plus application to the drive. The application list will remain empty if drive does not have Control Builder Plus.	Alt+A

Command	Description	Keyboard shortcut
Macro (pro)	Sets parameter values to multiple networked drives when custom window functionality is not sufficient. See Macro (pro) (page 148) and Macro commands (page 149).	Alt+M
Register drive	Registers an ABB drive in the Drive Installed Base service (DIB) portal. See Registering an ABB drive to Drive Installed Base service (page 174).	-
Search drive from Drive Installed Base	Retrieves information of a registered ABB drive in Drive Installed Base. You will need access permissions to Drive Installed Base portal. See Searching a registered ABB drive in Drive Installed Base (page 179).	-
Create service report	Creates service report of a registered ABB drive in Drive Installed Base. You will need access permissions to Drive Installed Base portal. See Creating a service report from Drive Installed Base (page 182).	-
Drive firmware loader	Downloads firmware to the drive. See Drive configuration on page 159.	-
FSO firmware loader	Updates FSO firmware version to the current version. You will need access to FSO module. See Updating FSO firmware (page 151).	-

■ Help menu

The Help menu is always located in the menu bar.

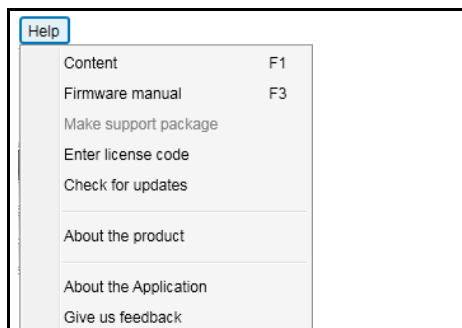



Figure 43. Help menu

Help menu commands

Command	Description	Keyboard shortcut
Content	Opens Drive Composer user manual as a PDF file.	F1
Firmware manual	<p>Opens firmware manual of the connected drive type in a separate window as a PDF file. If you selected a parameter or some other significant item when you clicked this command or pressed F3 key, the appropriate chapter in the firmware manual is displayed.</p> <p>You can also read the firmware manual of the connected drive by clicking on the <i>i</i> button.</p> 	F3
Make support package	Creates a single file that can be sent to the local ABB support contact if you need any support.	-
Enter licence code (pro)	Registers the Drive Composer license code, during the first-time launch of the software. See steps for Registering Drive Composer pro on page 144.	-
Check for updates	Checks for newer version of the software.	-
About the product	Displays Drive Composer software version and copyright text.	-

Drive control panel

The drive control panel is located below the menu bar. It has buttons for controlling a connected drive. It also shows the status of the drive.

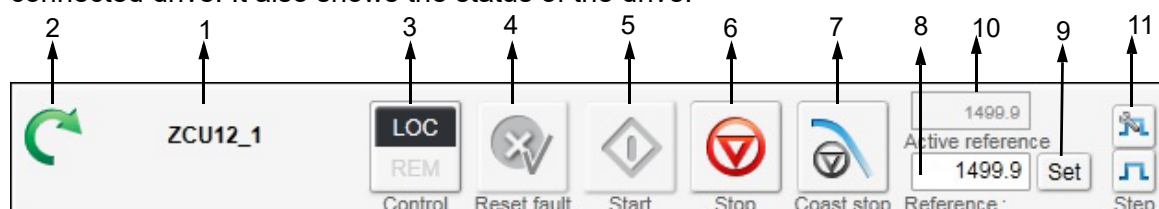
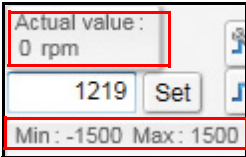



Figure 44. Drive control panel buttons/items

■ Drive control panel buttons/items description

Item no.	Button name	Description
1	-	Name and node number of the currently controlled drive.
2	-	Motor icon (clockwise open circle arrow) for drive status indication. For description, see Drives list panel: status indication (page 152)
3	Control	Allows controlling the selected drive through Drive Composer or allows releasing control of the drive.
4	Reset fault	Sends a reset command to the drive. If the fault is not active, the drive clears it.
5	Start	Starts the currently controlled drive. A motor connected to the drive starts rotating according to the set reference value.
6	Stop	Stops rotation of the motor connected to the currently controlled drive.
7	Coast stop	Coasts the currently controlled drive to stop.
8	Reference	<p>Allows entering a new reference value. The Reference field will show the current reference value used in the drive.</p> <p>When you click the Reference field, a tooltip shows the minimum and maximum limits for the reference and current/actual reference value.</p>  <p>For reverse direction, set the value manually with negative (-) sign.</p>
9	Set	Enforces the value in the reference value field to the currently controlled drive. You can also perform the same command by pressing ENTER.
10	Active reference	Displays the active reference value.
11	Step	<p> Activates step cycle with the reference value.</p> <p> Allows modifying Step type, Step value and Step duration with reference value. The available configuration is dependent on the connected drive.</p>

■ **Using the drive control panel to start the drive**

1. Set the drive parameter values necessary to start the drive. See firmware manual of the drive.
2. Click **Control** button.
The control box indicator changes to LOC.
3. Enter a reference value and press ENTER or click the **Set** button.
4. Click **Start**.
The drive starts. The indicator box arrow changes to green.

Note: Limit settings in parameter group 30 affect the reference limits.

Drives list panel

The drive list panel shows all connected drives and open files. The drives status is indicated with a motor icon (clockwise open circle arrow). For description of status, see [Drives list panel: status indication](#).

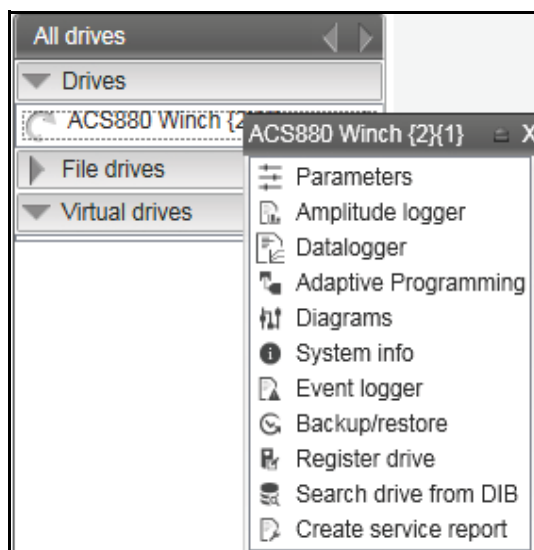



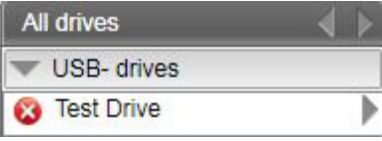

Figure 45. Drive list panel: Connected drives and context menu items

When you click on a connected drive type, a pop-up window/context menu appears with different drive view types.

Drive view	Description
Parameters	See Parameter window .
Amplitude logger	See Amplitude logger (pro) .
Datalogger	See Datalogger (pro) .
Adaptive Programming	See Adaptive programming .
Diagrams	See Control diagrams (pro) .
System info	See System info .
Event logger	See Event logger .
Backup/restore	See Using Drive Installed Base service and Restoring a drive .
Register drive	See Registering an ABB drive to Drive Installed Base service .
Search drive from Drive Installed Base	See Searching a registered ABB drive in Drive Installed Base .
Create service report	See Creating a service report from Drive Installed Base .

You can open those views either as new tabs or floating windows. If an active window is associated with a drive or a file, the corresponding tree item is highlighted in the drive list.

■ Drives list panel: status indication

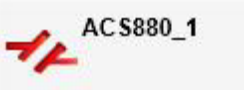
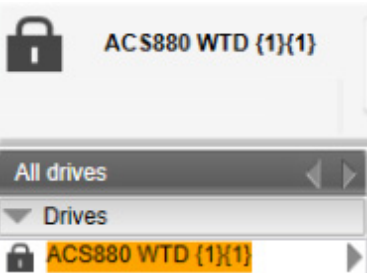
Status	Description
<p>Stopped drive</p> 	<p>A Grey circle arrow indicates a stopped drive.</p>
<p>Running drive</p> 	<p>A green circle arrow indicates a running drive.</p>
<p>Faulty drive</p> 	<p>A red circle with a white cross (x) indicates a faulty drive.</p>
<p>Alarm</p> 	<p>An orange background means that a drive has an alarm.</p>
<p>Broken connection</p> 	<p>A red broken line (—/ /—) means that the connection to a drive has broken.</p>
<p>RADIUS authentication enabled</p> 	<p>A lock symbol next to the Drive name means drive is enabled with RADIUS authentication and you must login for specific operations of the drive.</p>

Working area

The working area shows the following views:

- Parameter windows
- Custom parameter windows
- Event logger
- System info
- Control diagrams
- Assistants, and so on.

■ Using the working area

In the working area, you can

- use either tabs or floating windows
- adjust the size of the working area by dragging the white separating line up/down
- adjust the size of the drive list to the left/right
- resize the windows that are not maximized by dragging any corner
- scroll the content using scroll bars on the side or bottom of a window.

The user interface is tabbed by default. You can change the order of tabs by dragging them. You can open tabs for a single drive or for multiple drives.

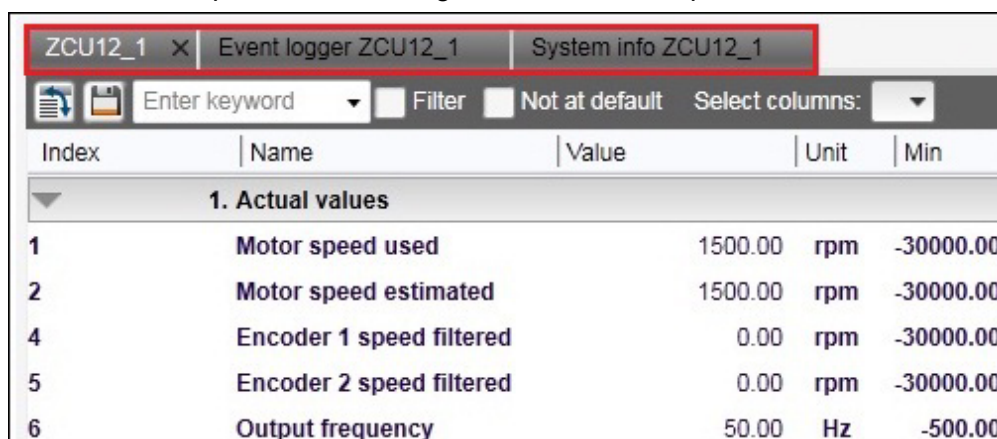

The screenshot shows a tabbed interface with three tabs: 'ZCU12_1', 'Event logger ZCU12_1', and 'System info ZCU12_1'. Below the tabs is a search bar with 'Enter keyword', a 'Filter' checkbox, a 'Not at default' checkbox, and a 'Select columns:' dropdown. The main content is a table with the following data:

Index	Name	Value	Unit	Min
1. Actual values				
1	Motor speed used	1500.00	rpm	-30000.00
2	Motor speed estimated	1500.00	rpm	-30000.00
4	Encoder 1 speed filtered	0.00	rpm	-30000.00
5	Encoder 2 speed filtered	0.00	rpm	-30000.00
6	Output frequency	50.00	Hz	-500.00

Figure 46. Working area: Tabbed user interface

You can set the working area to a floating window. For example, parameter window, event logger, system info, etc. can be shown as floating windows. You can also tile the floating windows vertically or horizontally, or cascade using the **View** menu commands.

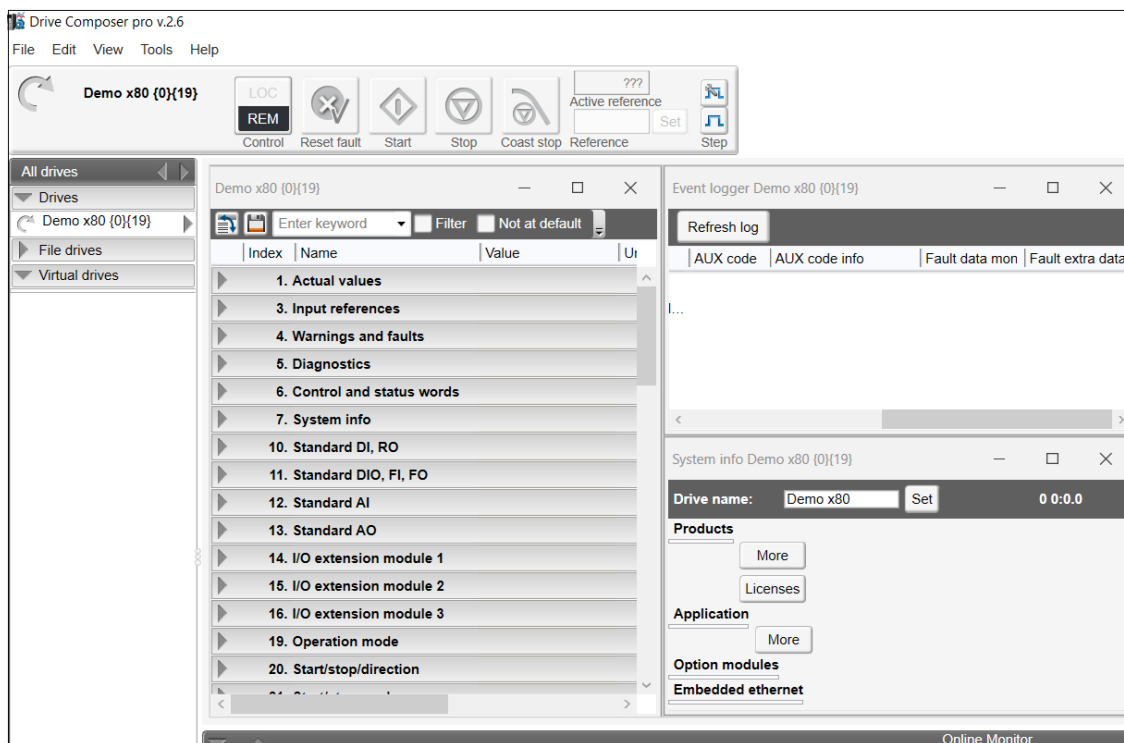

Figure 47. Working area: Floating windows



Parameter window

Contents of this chapter

This chapter describes the parameter and custom parameter windows.

See topics:

<i>Parameter window overview</i>	138
<i>Parameter window command icons</i>	139
<i>Parameter window: view parameters</i>	140
<i>Parameters list representation</i>	140
<i>Navigating parameters and groups</i>	141
<i>Updating parameter values</i>	141
<i>Hidden parameters</i>	141
<i>Alternate formats to view parameters</i>	141
<i>Viewing bit names</i>	142
<i>Pointer parameters overview</i>	144
<i>Inverting a bit pointer</i>	145
<i>Setting fieldbus data in/out parameters</i>	146
<i>Binary parameters</i>	148
<i>Search for groups and parameters</i>	149
<i>Custom parameter window</i>	150
<i>Custom parameter window features</i>	150
<i>Saving custom parameter window</i>	150
<i>Viewing copied parameter values</i>	151
<i>Adding parameters to a custom parameter window</i>	151
<i>Working with offline files</i>	154
<i>Types of offline files</i>	154
<i>Saving parameters to a parameter file</i>	154
<i>Opening a parameter file (entry)</i>	155
<i>Opening an offline file containing parameter values (pro)</i>	155
<i>Downloading parameter values to a drive</i>	155
<i>Comparing drive data (pro)</i>	156
<i>User set functionality (Pro)</i>	158

User set overview 158
User set system requirements 158
Limitations 158
Starting the user set function 159
Creating user set 161
Active and unsaved user set 161
Saving user set 162
Copying user set parameter values 162
Removing user set 163
Show/hide user set 164
User set parameters limitation 164

Parameter window overview

The parameter window view displays parameter groups, parameters and their values for the associated drive or a file. The working area can show several parameter windows. The headline of each parameter window shows which drive it belongs to.

- With Drive Composer entry, the parameter window opens only when the drive is connected.
- With Drive Composer pro, the parameter window opens by clicking on the selected drive in the drive list panel and selecting **Parameters**.

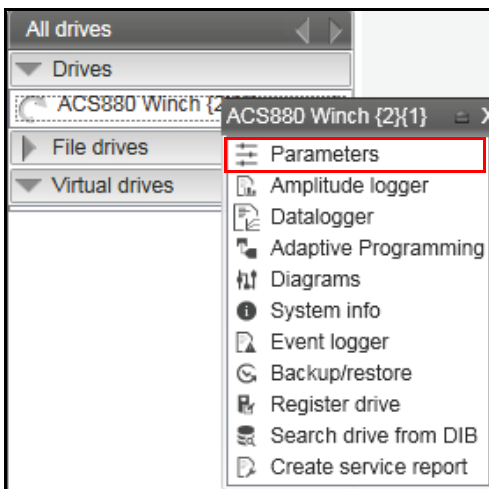



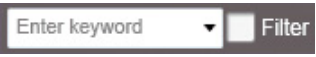

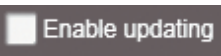

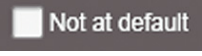



Figure 48. Parameter window: Open drive parameters

■ Parameter window command icons

Icon	Description
	Expands/collapses parameter groups. When parameter groups are expanded, all parameter values are read once from the drive.
	Saves parameters to a file. Saves visible parameters to a file. File extension is dparams(bak).
	Enables User set function and allows to add, remove, copy and save User set parameters.
	Enables you to search parameter lists with a keyword. Search is activated/deactivated by clicking the Filter check box. When the Filter check box is unchecked all parameters are seen. Note: If parameter groups have not been expanded, the first search takes about 30...60 seconds.
	Allows you to select/deselect columns to be seen in a parameter window.
	Parameters are updated only when a group is opened. With the Enable updating function it is possible to set all open and visible groups to be updated automatically. Parameters that have been set to be updated automatically have a yellow background.
	Allows you to download parameters from a file to a drive. With a custom parameter window allows downloading offline values to a drive.
	Enables you to change the window target, which is useful if you have Drive Composer pro and you have to check certain parameters of another drive. Included only in custom parameter windows.
	Provides you with a list of all user-changed parameters if you click the check box. These parameters have an orange background.
	Allows you to add or remove one parameter or signal or several parameters or signals to/from a custom parameter window.

Parameter window: view parameters

Index	Name	Value	Unit	Min	Max	Default
1. Actual values						
1	Motor speed used	0.00	rpm	-30000.00	30000.00	0.00
2	Motor speed estimated	0.00	rpm	-30000.00	30000.00	0.00
4	Encoder 1 speed filtered	0.00	rpm	-30000.00	30000.00	0.00
5	Encoder 2 speed filtered	0.00	rpm	-30000.00	30000.00	0.00
6	Output frequency	0.00	Hz	-500.00	500.00	0.00
7	Motor current	0.00	A	0.00	30000.00	0.00
10	Motor torque %	0.0	%	-1600.0	1600.0	0.0
3. Input references						
4. Warnings and faults						
5. Diagnostics						
6. Control and status words						
7. System info						
10. Standard DI, RO						
1	DI status	0b1000 0000 0000	NoUnit	0b0000	0b1111 11	0b0000
2	DI delayed status	0b1000 0000 0000	NoUnit	0b0000	0b1111 11	0b0000
3	DI force selection	0b0000	NoUnit	0b0000	0b1111 11	0b0000
4	DI force data	0b0000	NoUnit	0b0000	0b1111 11	0b0000
5	DI1 ON delay	5.0	s	0.0	3000.0	0.0
6	DI1 OFF delay	0.0	s	0.0	3000.0	0.0
7	DI2 ON delay	0.0	s	0.0	3000.0	0.0
8	DI2 OFF delay	10.0	s	0.0	3000.0	0.0
9	DI3 ON delay	0.0	s	0.0	3000.0	0.0
10	DI3 OFF delay	0.0	s	0.0	3000.0	0.0

Figure 49. Parameter window: Selected drive parameters

Parameters list representation

The parameter window contains different types of parameters. Some of these types are identified by colors or bold fonts as shown in the table below:

Illustration	Explanation
20.3 Ext1 In1 source D1	Normal parameters
1.1 Motor speed used 0.00 rpm	Signals (bold)
10.21 RO status 0b0100	Bit names of a parameter can be seen by double-clicking on the parameter. New window opens.
11.6 DIO1 output source P.10.1.1	Parameter value is set from another parameter, for example, parameter group 10, index 1, bit 1.
11.6 DIO1 output source P.10.1.1 -	Parameter value is an inverted bit of another parameter, group 10, index 1, bit 1.
20.1 Ext1 commands In1 Start	User has changed the value of a parameter (shown with an orange background).

Note:

- The most common type is the regular parameter.
- Parameters are normally readable and writable. However, when the drive is running, some parameters may be write-protected.
- The parameter view shows: Parameter names, values, units, default values and different user sets. The number of user sets depends on the drive type.
- The value of a parameter is read only once. If it is necessary to update this value, right-click and select **Refresh the parameter**.
- You can set all visible parameters to update automatically by clicking the **Enable updating** button.
- You cannot modify values of signals. If you attempt to modify a signal, an error is indicated. Signals are updated cyclically in the parameter window.
- Parameter signals are also updated frequently, but you can modify these values.

Navigating parameters and groups

■ Updating parameter values

Parameter values are updated if they are modified.

- To modify a parameter value, double-click the parameter or press ENTER on the highlighted parameter.
- To update a parameter group value, right-click the group name and select **Refresh group parameters**.

■ Hidden parameters

In special cases, hidden parameters and groups become available by modifying some parameter values. The **View** → **Refresh** command updates the whole parameter table. For example, group *51 FBA A Settings*: When the adapter module is enabled in group 50, you can see parameter names by selecting **View** → **Refresh**.

Note: Close the parameter window before refreshing and open again after refreshing.

■ Alternate formats to view parameters

There are five alternative formats in which parameters are shown: default, binary, hexadecimal, integer and float format.

To change the format of a parameter, right-click and select either **Use default format**, **Use binary format**, **Use hexadecimal format**, **Use integer format** or **Use float format**.

You can change the widths of the columns by dragging the vertical lines between the column headers.

■ Viewing bit names

To see the bit names of certain binary parameters, double-click the value field box. For example, see the below parameter *10.1 DI status*.

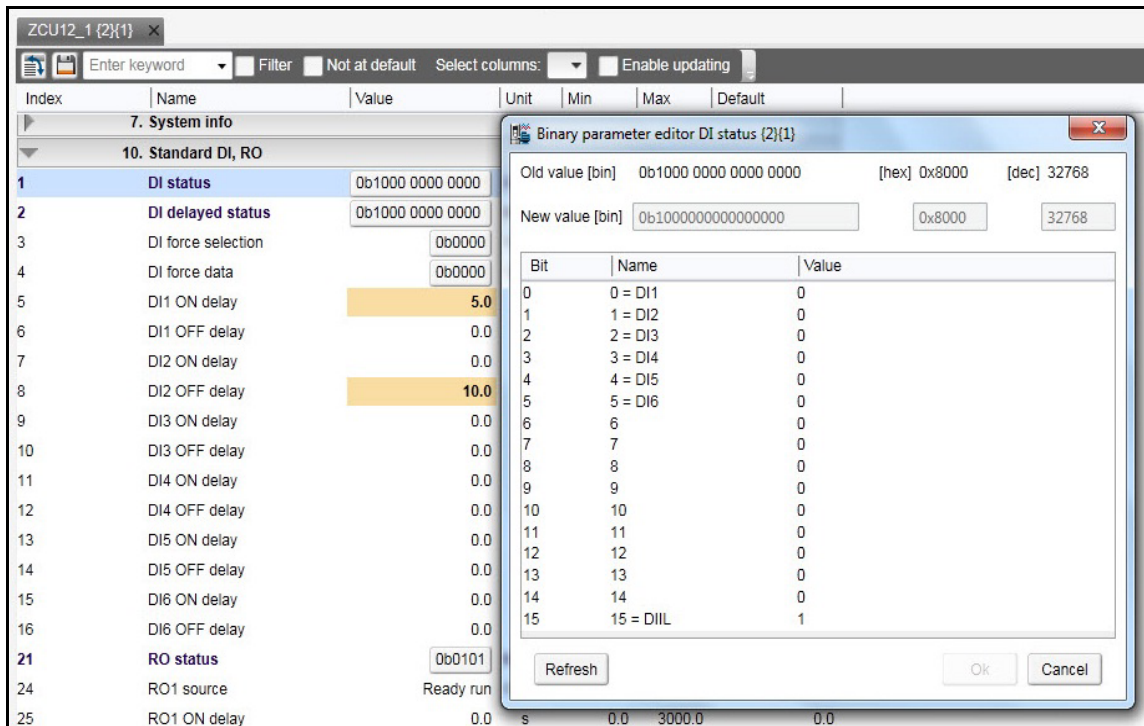

Figure 50. Navigating parameters and groups: Parameter bit names

To reset a parameter, right-click and select **Reset to default**.

Parameter values are read once when a group is opened. You can set independent parameters from different groups to the Auto-update mode by right-clicking and selecting **Add to auto-update**. The parameters that are updated automatically are seen with a yellow background as shown in the following figure.

Note: Signals are automatically updated cyclically

Index	Name	Value	Unit	Min	Max	Default
19. Operation mode						
1	Actual operation mode		Speed	NoUnit		Speed
11	Ext1/Ext2 selection	EXT1	NoUnit			EXT1
12	Ext1 control mode		Speed	NoUnit		Speed
14	Ext2 control mode		Speed	NoUnit		Speed
16	Local control mode		Speed	NoUnit		Speed
17	Local control disable	No	NoUnit			No
20	Scalar control reference unit		Rpm	NoUnit		Rpm
20. Start/stop/direction						
21. Start/stop mode						
22. Speed reference selection						
23. Speed reference ramp						
24. Speed reference conditionii						
25. Speed control						
26. Torque reference chain						
28. Frequency reference chain						

Figure 51. Navigating parameters and groups: Parameters with yellow background

Parameters or signals can be sent to the monitor window by right-clicking them and selecting **Send to monitor**. Parameters can be copied to a custom parameter window by right-clicking them and selecting **Copy**. In addition, you can drag and drop parameters to a custom parameter window.

Pointer parameters overview

Pointer parameter is a special type of parameter that reads value from the parameter it points to. Depending on the pointer parameter, value or bit pointer, its target can be another parameter or one of its bits. You can assign Active (false) or Inactive (true) status to some pointer parameters.

21. Start/stop mode			
1	Start mode	Automatic	NoUnit
2	Magnetization time	500	ms
3	Stop mode	Coast	NoUnit
4	Emergency stop mode	Ramp stop (Off1)	NoUnit
5	Emergency stop source		NoUnit
6	Zero speed limit		
7	Zero speed delay		
8	DC current control		
9	DC hold speed		
10	DC current reference		
11	Post magnetization time		
13	Autophasing mode		

Figure 52. Pointer parameters: Constant value

Typically, common settings are offered as a selection list. If the selection list does not offer the correct pointer, you can set the pointer by selecting **Other...** from a selection list. Select a parameter from the list for a value pointer and then its bit from 0 to 31 for a bit pointer.

You can also enter a value manually by selecting the Edit manually check box. Use the value form P.##.#, where the first # is the parameter group number, the second # is the parameter number and the third # is the bit number without leading zeros (for example P.2.1.2). The constant values are Active (false) or Inactive (true).

■ **Inverting a bit pointer**

In the Set pointer parameter window, select Invert value check box.

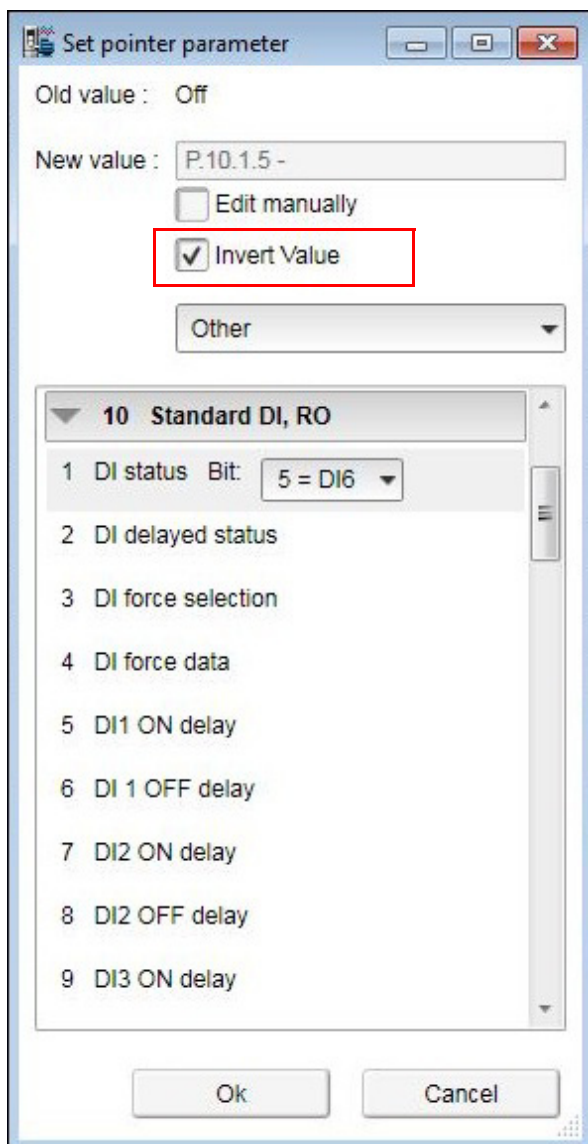

Figure 53. Pointer parameters: Inverting a bit pointer value

The inverted bit pointer value is shown with the minus sign at the end of the parameter.

20. Start/stop/direction			
1	Ext1 commands	In1 Start; In2 Dir NoUnit	In1 Start; In2 Dir
2	Ext1 start trigger	Edge NoUnit	Edge
3	Ext1 in1	P.10.1.5 - NoUnit	D11

Figure 54. Pointer parameters: Inverted bit pointer value with minus sign

■ **Setting fieldbus data in/out parameters**

Process data transferred to and from the drive/PLC is set with parameter groups 52 and 53. With an ACS880 drive it is possible to select the data type for each selected parameter/signal in these groups.

1. Double-click FBA data in/out parameter and select **Other**.

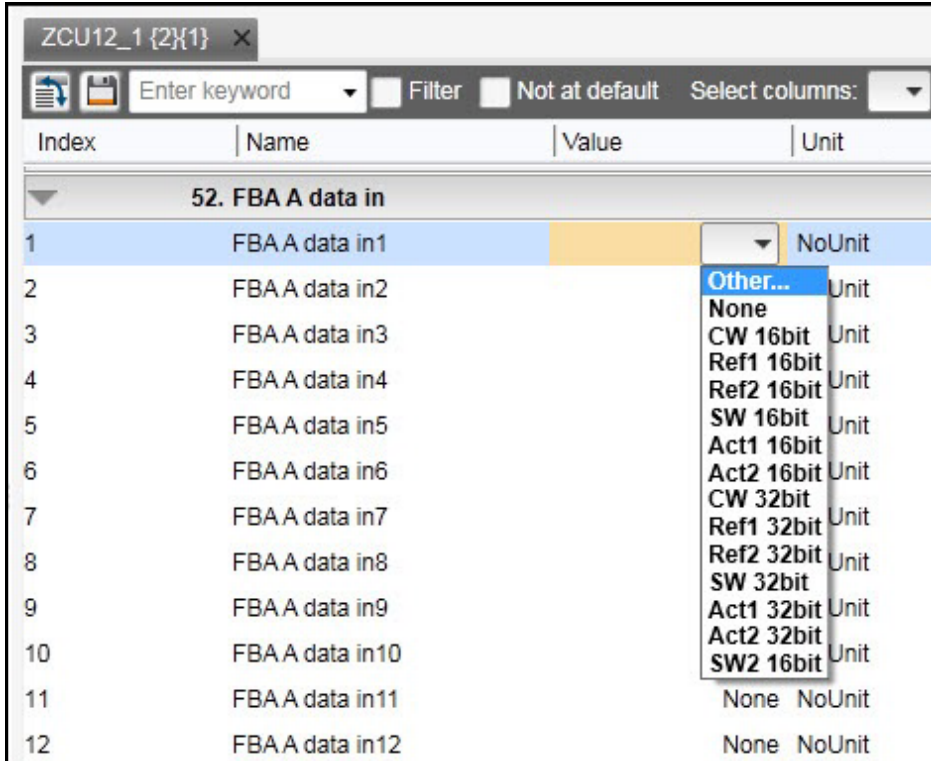

Figure 55. Setting fieldbus data in/out parameters: Select data type

2. Select the format in which the value is handled: 16-bit, 32-bit or floating point format.

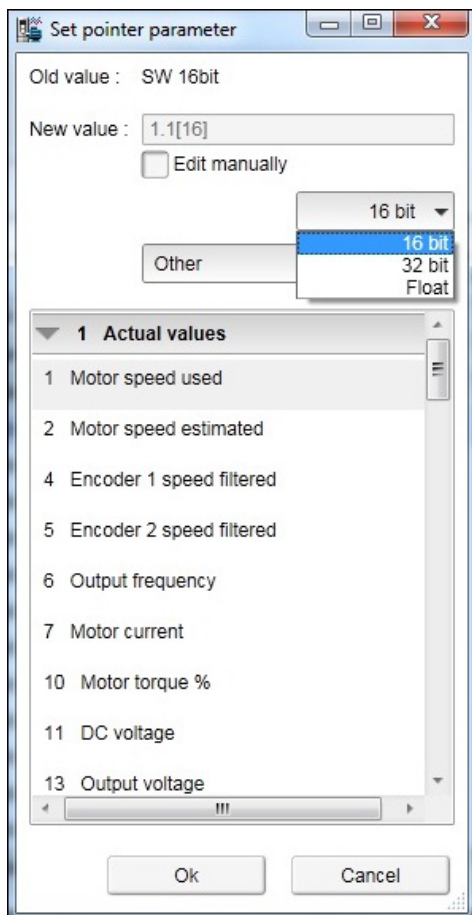

Figure 56. Setting fieldbus data in/out parameters: Select format

In the parameter window the selections are shown inside brackets: [16], [32] or [F].

52. FBA A data in			
1	FBA A data in1	1.1[16]	NoUnit
2	FBA A data in2	1.11[16]	NoUnit
3	FBA A data in3	1.7[16]	NoUnit
4	FBA A data in4	None	NoUnit
5	FBA A data in5	1.4[16]	NoUnit

Figure 57. Setting fieldbus data in/out parameters: Formats shown inside brackets

Note:

- The floating point or 32-bit value reserves two slots in the configuration. Consequently, if you try to select a value for parameter 52.04 as in the figure above, a Parwrite failed error message appears. See the scalings of parameters/signals in *ACS880 primary control program firmware manual* (AUA0000085967 [English]).
- Always check the parameter mapping from the manual of the used fieldbus protocol. Example, FENA-01/-11/-21 Ethernet adapter module user's manual (3AUA0000093568 [English]) or FPBA-01 PROFIBUS DP adapter module user's manual (3AFE68573271 [English]).

Binary parameters

Binary parameters have a special meaning for each of their bits. These parameters are modified in a special Set binary parameter dialog. You can modify the value numerically in binary, hexadecimal or decimal format.

- One way to modify the value in the field is, double-click the value field for each bit. Some bits may be greyed out or disabled to edit.
- Another way to modify a bit is to type the bit value directly to the New value [bin] / [hex] / [dec] field.

You can view the binary format of signal values in a similar dialog.

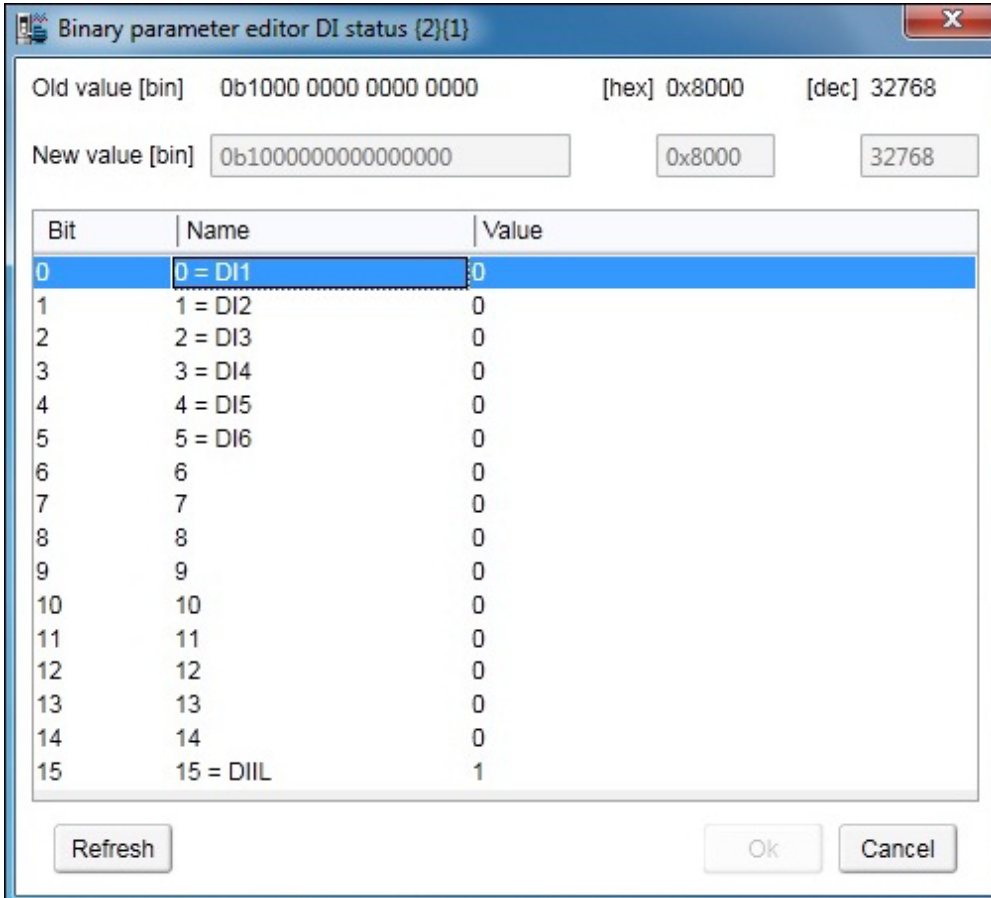
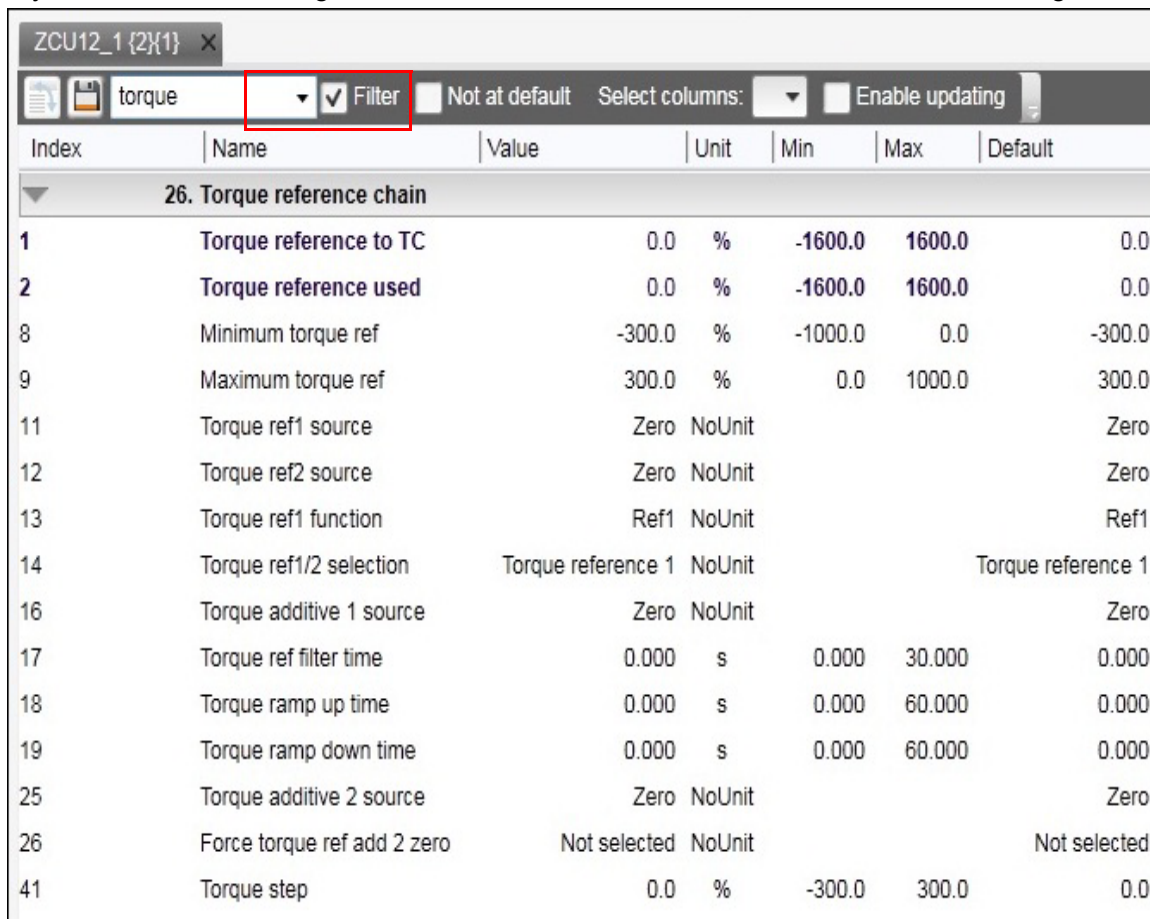

Figure 58. Binary parameter editor

Search for groups and parameters

You can search the names of parameters and groups inside the parameter window. The search result is a list of all parameters matching the search text criteria. For example, all torque-related parameters can be found by entering search criteria “torque” in the Enter keyword field and clicking the Filter check box. To uncheck the Filter box, click it again.



Index	Name	Value	Unit	Min	Max	Default
26. Torque reference chain						
1	Torque reference to TC	0.0	%	-1600.0	1600.0	0.0
2	Torque reference used	0.0	%	-1600.0	1600.0	0.0
8	Minimum torque ref	-300.0	%	-1000.0	0.0	-300.0
9	Maximum torque ref	300.0	%	0.0	1000.0	300.0
11	Torque ref1 source	Zero	NoUnit			Zero
12	Torque ref2 source	Zero	NoUnit			Zero
13	Torque ref1 function	Ref1	NoUnit			Ref1
14	Torque ref1/2 selection	Torque reference 1	NoUnit			Torque reference 1
16	Torque additive 1 source	Zero	NoUnit			Zero
17	Torque ref filter time	0.000	s	0.000	30.000	0.000
18	Torque ramp up time	0.000	s	0.000	60.000	0.000
19	Torque ramp down time	0.000	s	0.000	60.000	0.000
25	Torque additive 2 source	Zero	NoUnit			Zero
26	Force torque ref add 2 zero	Not selected	NoUnit			Not selected
41	Torque step	0.0	%	-300.0	300.0	0.0

Figure 59. Search groups and parameters: example

Note: The first search takes about 30...60 seconds, because Drive Composer goes through the whole parameter structure. The next searches are fast. All searches are in memory of the PC as long as Drive Composer is on.

Custom parameter window

In Drive Composer you can customize parameter windows by:

- dragging and dropping parameters/signals
- changing parameter values
- copying from the main parameter window or from any other custom parameter window
- renaming custom parameter windows.

For example, you can

- collect all the typical parameters used in a quick start-up to one window or
- create separate windows for separate functions (example: references, limits, ACS880 I/O).

■ Custom parameter window features

The Custom parameter window

- opens automatically when a connection to a drive is made because they are saved with the workplace.
- can be used both in tabbed and floating windows environment.
- can also be opened separately.

■ Saving custom parameter window

To save a separately opened custom parameter window to a file, select **Save parameters to file**. Note that changed values in the Offline value column are also saved. You can use the saved file for parameterization of another drive. You can also send this file to other users to open the file with Drive Composer and view the parameters list.

Note: When you saved a custom parameter window, the actual drive values of the Value column are copied to the Offline value column. During loading, the values in the Offline value column are shown in comparison with the current actual values. From the saved customer parameter window file you can copy the values of the Offline value column to another drive by clicking the **Download to device** button.

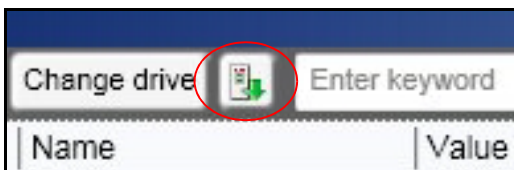

Figure 60. Custom parameter window: Download to device button

■ Viewing copied parameter values

In a network of drives, you can create a custom parameter window including parameters/signals selected from different drives. To have a view where all parameters are from one drive, click the **Change drive** button and select the drive.

To see the value of a parameter/signal used in another drive, right-click the parameter/signal and select **Change drive**.

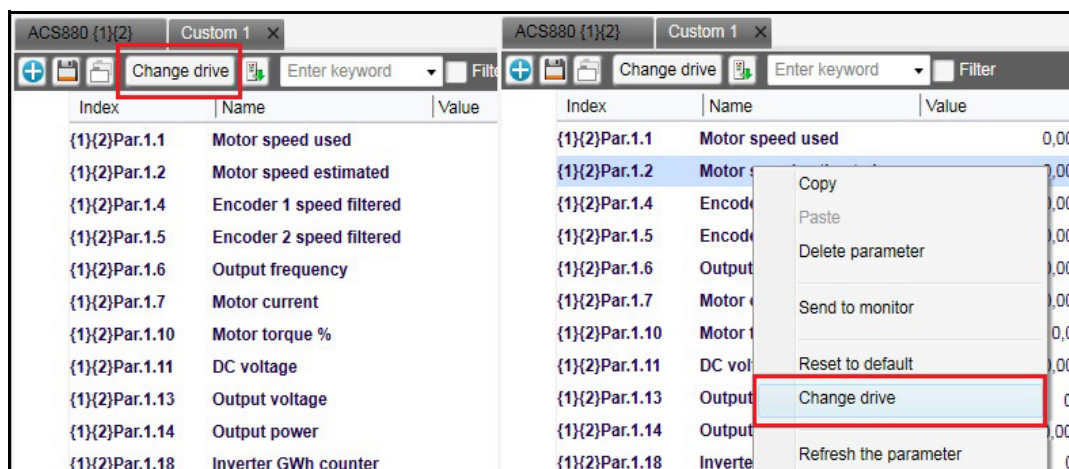

Figure 61. Custom parameter window: Change drive

■ Adding parameters to a custom parameter window

The following example shows how to:

- create a new custom parameter window
 - add parameters to a custom parameter window
 - modify the Offline value column in the custom parameter window
 - copy/download parameters to a drive.
1. Click **File** → **New** → **Custom parameter set**.

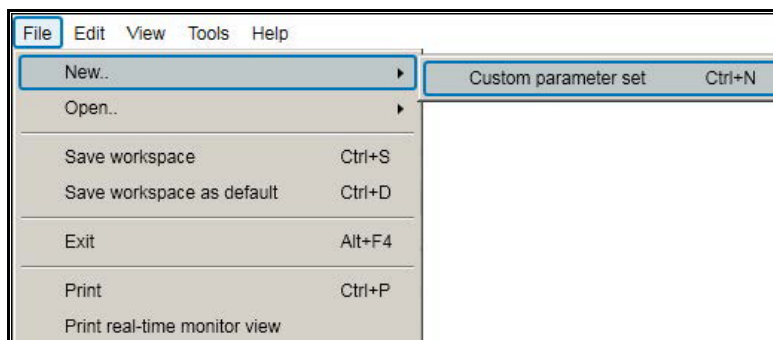

Figure 62. Custom parameter set

2. Name the custom parameter window.

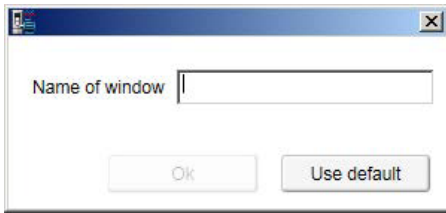

Figure 63. Custom parameter set: Name of window

3. Click **Add** button to add parameters/signals to the new custom parameter window or copy paste from other parameter window.

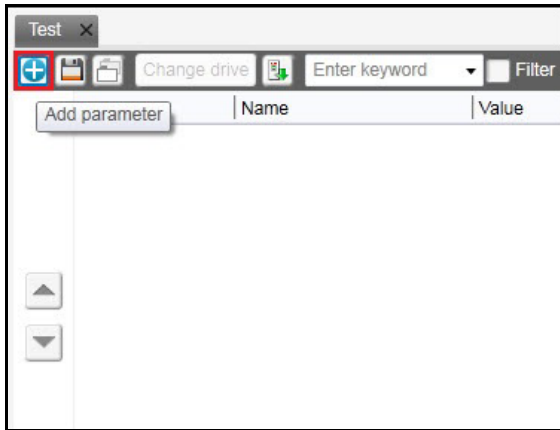

Figure 64. Custom parameter set: Add parameter

4. For example, select minimum and maximum speed values from the parameter group **30 Limits** and click **Apply changes**.

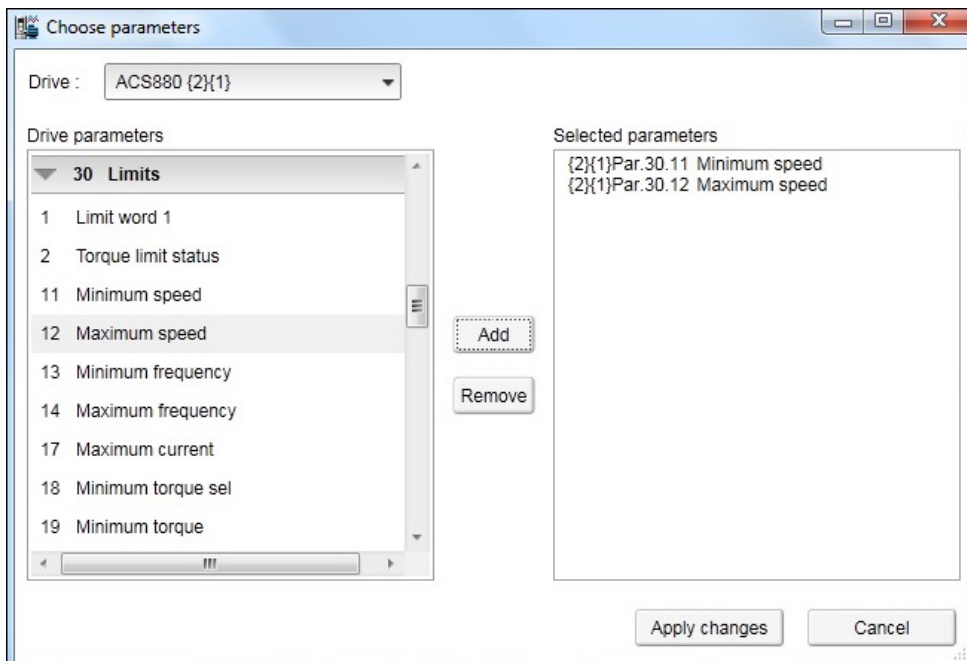

Figure 65. Custom parameter set: Add minimum and maximum values

- The **Value** column shows the values of connected drive. Enter values in the **Offline value** column to be same as **Value** column or you can type new values.

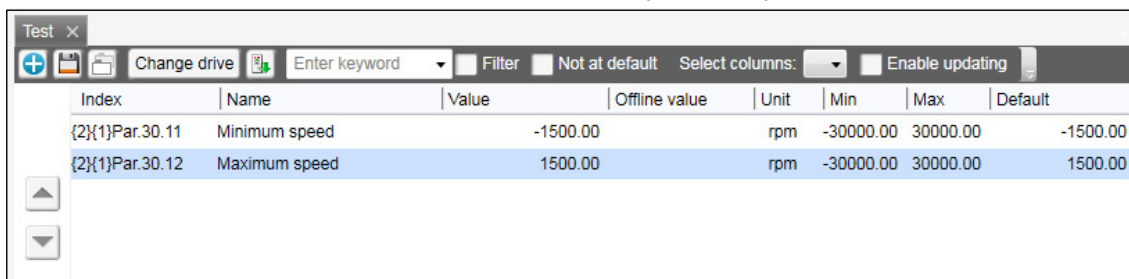

Figure 66. Custom parameter set: Change Offline values

- Click on **Save parameters to file** icon to save the custom parameter window.

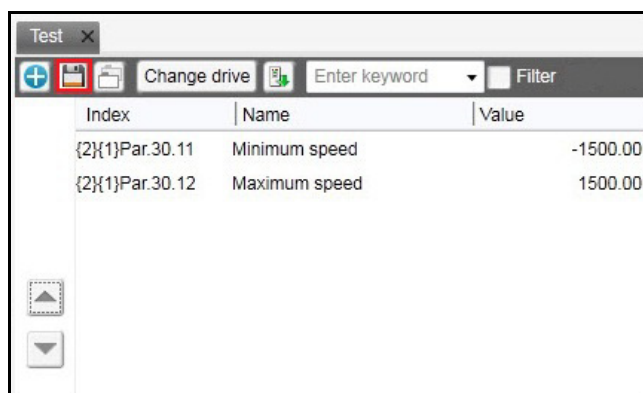

Figure 67. Custom parameter set: Save parameter to file

Drive Composer saves to file the values in the **Offline value** column. If the **Offline value** column was empty, then values in the **Values** column is saved.

- When connecting the next drive open the created custom parameter window by clicking **File** → **Open** → **Custom parameter file**.
You can now see the online values of the new drive.
- Copy the offline parameter values to a new drive by clicking on **Download to device** icon.

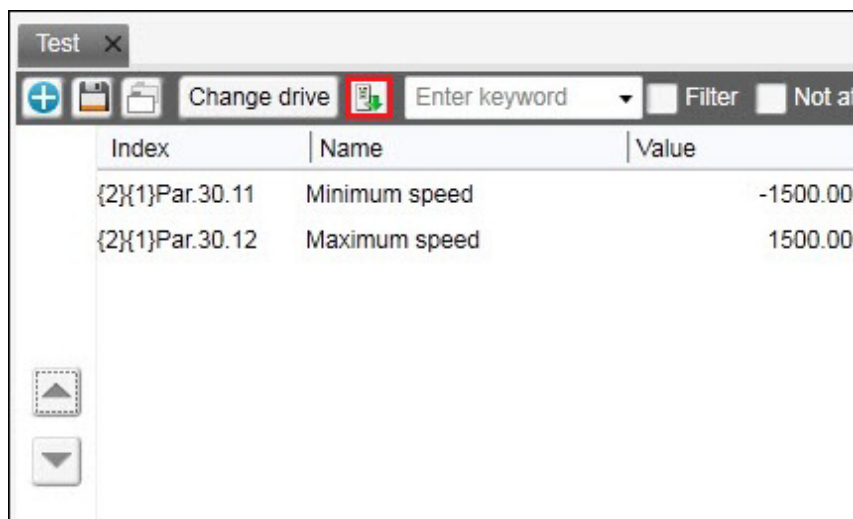

Figure 68. Custom parameter set: Copy offline parameter values to a new drive

Working with offline files

Types of offline files

There are two types of offline files containing parameter information.

- **Parameter file** is an offline file containing all parameter values.
- **Support package** is an offline file package that contains a collection of drive information, including all parameter values. You can open a support package file using Drive Composer pro. For further information on support package, see chapter [Diagnostics](#) on page 137.

Saving parameters to a parameter file

1. Connect Drive Composer to a drive and open the parameter window.
2. In the parameter window, click **Save parameters to file** icon.

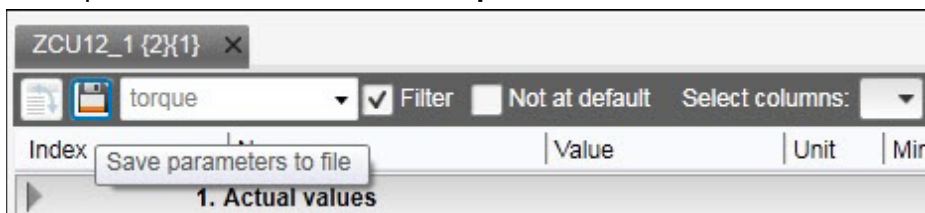

Figure 69. Save parameters to file

3. Select a folder, enter a name for the *dcparamsbak* file and click **Save**.

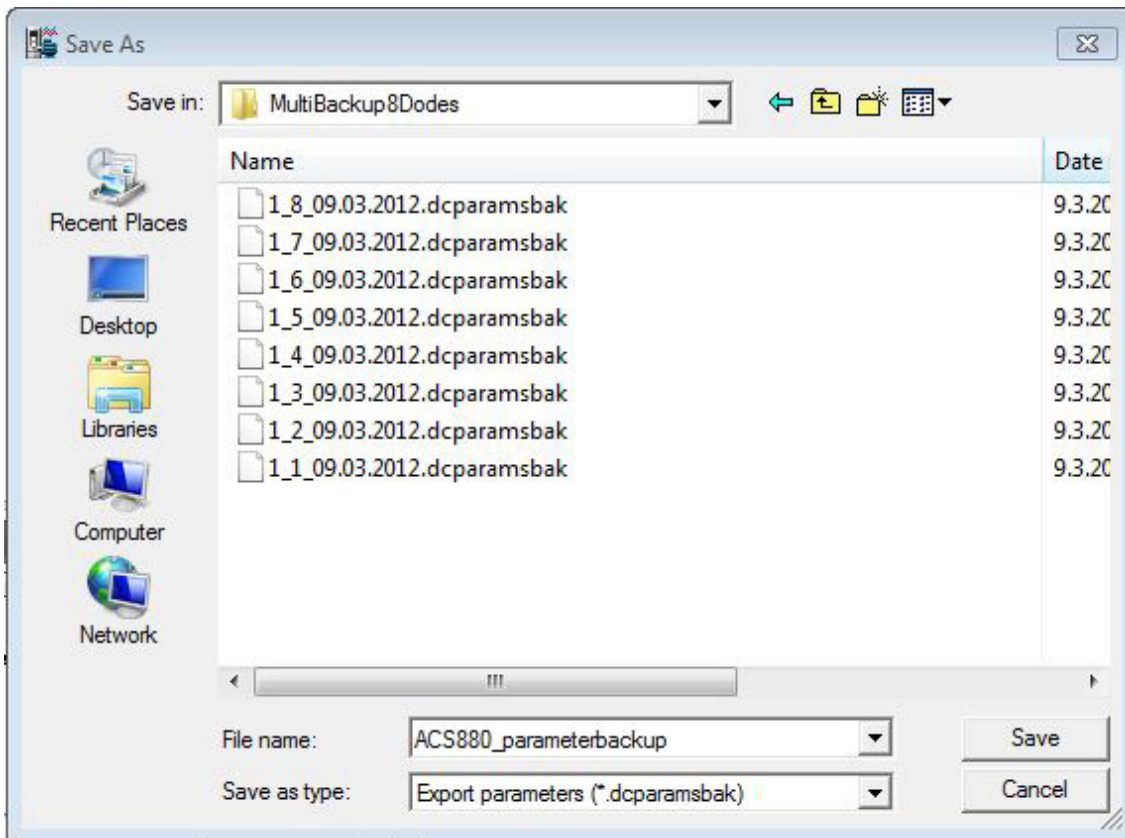

Figure 70. Save parameters to file: Save the *dcparamsbak* file

■ Opening a parameter file (entry)

To open a parameter file and view the parameter values offline, proceed as follows:

1. Connect to a drive.
2. Go to **File** → **Open** → **Parameter file**.
3. Parameter window displays.

■ Opening an offline file containing parameter values (pro)

To open a file and view the parameter values offline, proceed as follows:

1. Connect to a drive.
2. Go to **File** → **Open** → **Parameter file / Open Support package**.
3. New item appears under **File drives**.
4. Select **Parameters** to open parameter window.

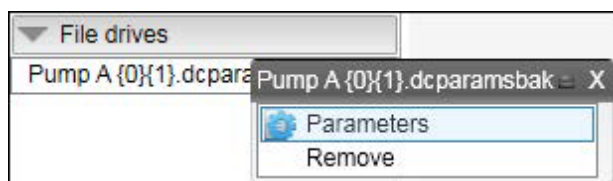

Figure 71. Opening an offline parameter file

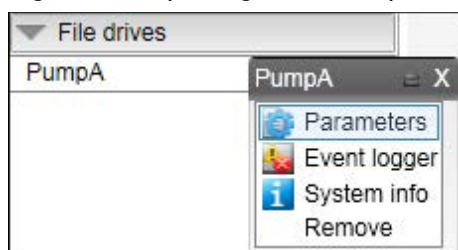

Figure 72. Opening an offline parameter file from support package

■ Downloading parameter values to a drive

Note: The operation do not perform full restore. Only visible parameters and ID run results are copied to a drive when the download command is used. Also, drive type and software version are not checked when downloading parameter values from an offline file to a drive. For further information on Restore function, see chapter [Other functions](#) on page 173.

To download offline parameter values to a drive, proceed as follows:

1. Open an offline parameter window.
2. If you have multiple drives connected online, click **Change drive** to select a drive you want to download the parameters.

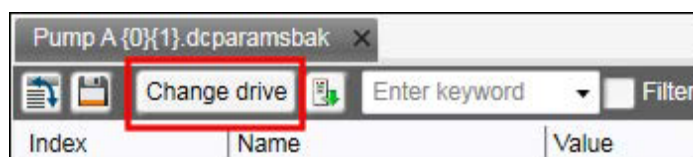

Figure 73. Downloading parameter values: Change drive

- Download the parameter values to a drive by clicking the **Download to device** icon.

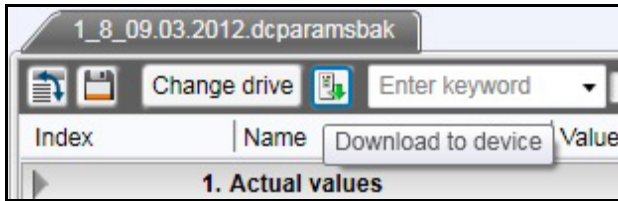

Figure 74. Downloading parameter values: Download to device icon

- If you get a message indicating that the upload of parameter values is going on, click **OK**.

You will get a report of the operation at the end of the restore operation.

- Check the parameters that are failed during the restore operation.

■ Comparing drive data (pro)

Note: Both versions of Drive Composer have **Not at default** function for listing user-changed parameters. The **Compare drive data** function compares parameter values.

With Drive Composer pro you can compare parameters between

- two drives
- two parameter files
- drive and parameter file.

- Go to **Tools** → **Compare drive data (Alt+C)**.

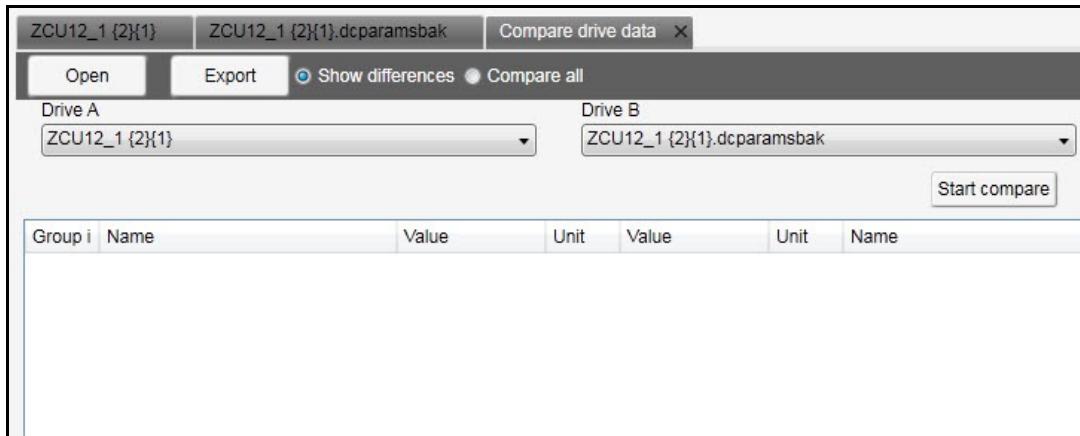

Figure 75. Comparing drive parameters

- In a PC tool network, select drives from **Drive A** and **Drive B** drop-down menus.
- To open a parameter file for comparison, click **Open**.
- To see the parameter list without differences, deactivate **Show differences** check box.
- Click **Start compare**.

Note: The operation may take some time to compare two different parameter structures.

The following figure shows an example of the result.

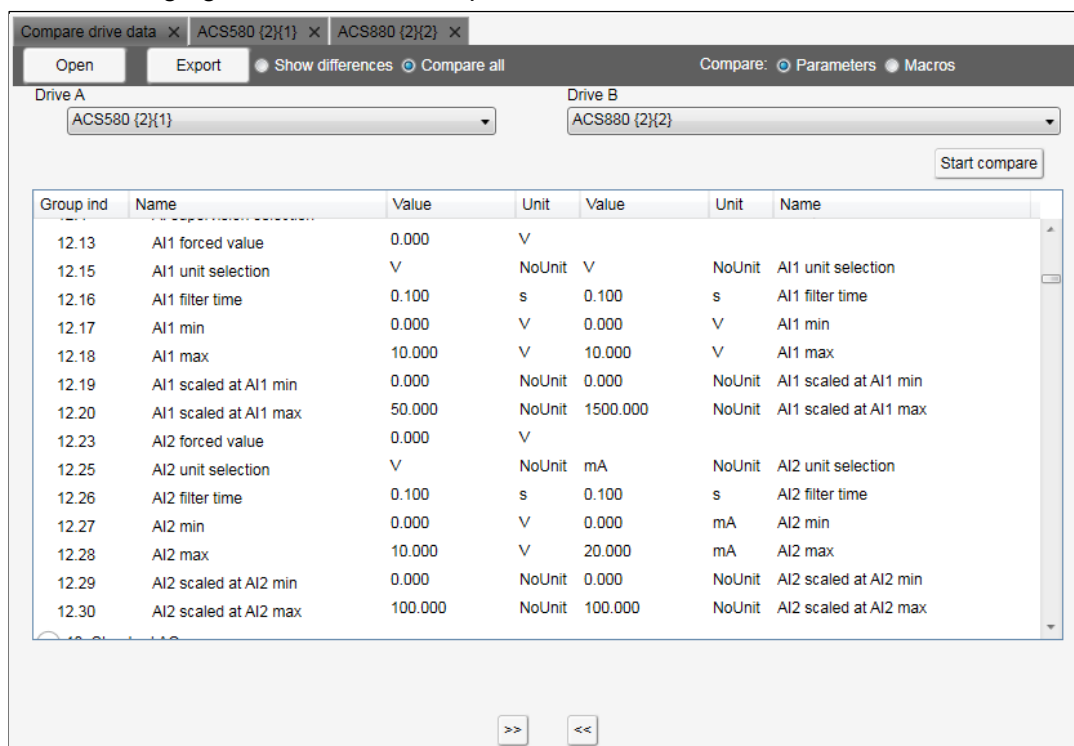

Figure 76. Comparing drive parameters: Result of comparison

6. To export the result to a text (*.txt) file, click the **Export**.

Note: Click the >> << buttons to copy parameter values from Drive A to Drive B.

User set functionality (Pro)

■ User set overview

User set or user parameter set functionality is an interface to work with user set parameters. The user set parameters can be saved to the permanent memory of the drive and recalled using specific parameters. Digital inputs allow switching between the user sets. Multiple user sets can be used to control multiple motors through a single drive.

With the User set function, you can:

- create user sets (see page [161](#))
- save user sets (see page [162](#))
- compare user set values side-by-side
- copy parameter values between user sets (see page [162](#))
- delete user sets (see page [163](#)).

■ User set system requirements

The User set functionality is available only if the following requirements are satisfied:

- PC must have the configurations listed in [System requirements](#) on page [21](#).
- Virtual drives software must be installed in your PC, otherwise the User set function is hidden.
- You must have a valid Virtual drives license.
- You must register the Virtual drives license with ABB license manager. Note that ABB license manager is installed together with the Virtual drives software.

■ Limitations

The User set function

- is supported only in ACS880 drive
 - works only in the parameter window from where it was enabled.
 - works only in one parameter window, i.e., you must disable the function (if enabled) in any other parameter window to allow the function in the current window.
-

■ Starting the user set function

To start or stop the user set function,

1. In the Drive Composer pro Welcome window, make sure that the **Virtual drive enabled** option is not checked. Click **Connect**.



2. Open the Parameters file or the parameters backup file.
The User set function is visible in the parameter window tool bar.
3. Click the User set drop down menu. By default the User set function is disabled.

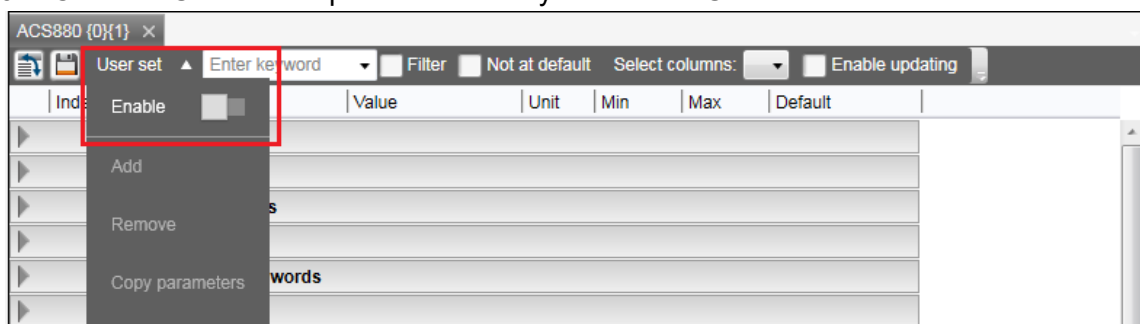

4. Click on the **Enable** switch.
 - If drive firmware version or the parameter backup file is deviated from the virtual drive, then Drive Composer notifies that User set parameters may be incompatible for editing. Note that small deviations may not affect the User set functionality. Click **Yes**, to proceed.

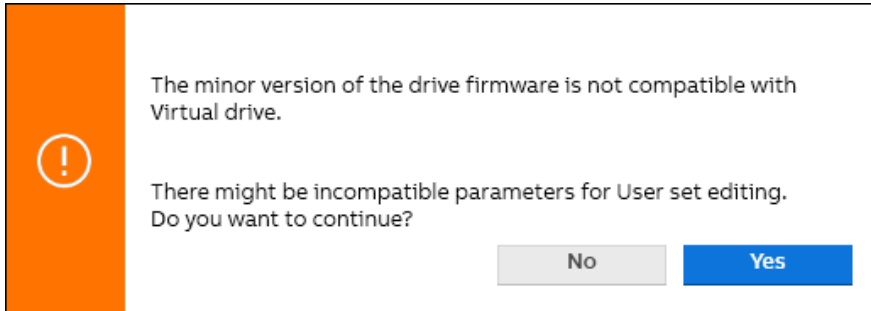

- If drive firmware version is not compatible with the virtual drive version, then User set functionality can not be started. Click **OK**. to close the window. You can either update the Virtual drive version or contact your local ABB representative for support.

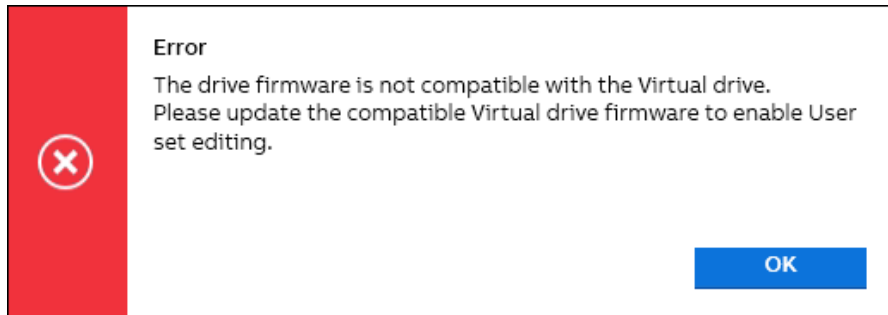

5. User set initialization starts. If initialization is complete, click **OK**.

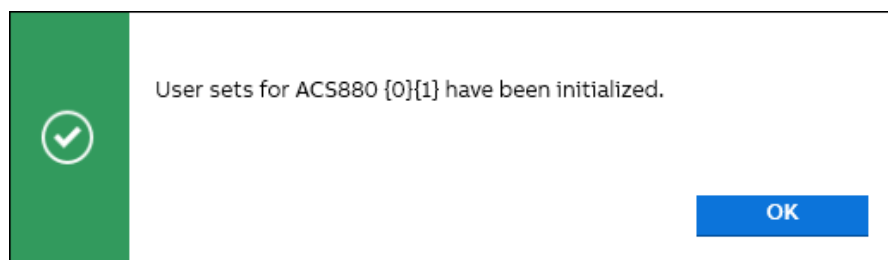

6. User set function is enabled. The enable switch color appears in blue.

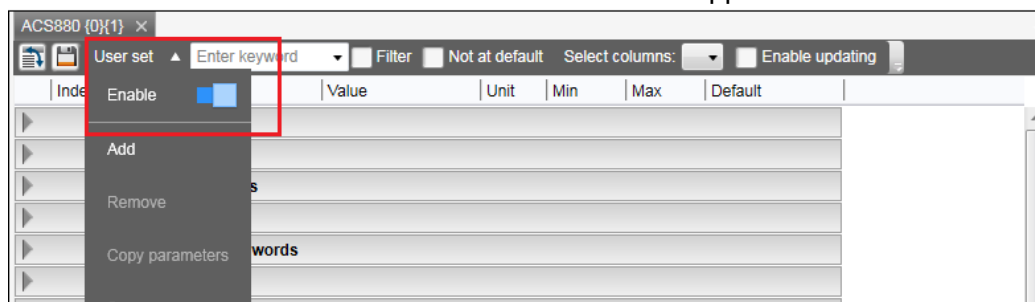

Note: To disable or stop the User set function, click the enable switch again. The switch color appears in Grey.

If user sets was configured in the connected drive or saved in the parameter backup file, the available user set is displayed in different columns next to each other.

■ Creating user set

1. In the User set menu, click **Add**.

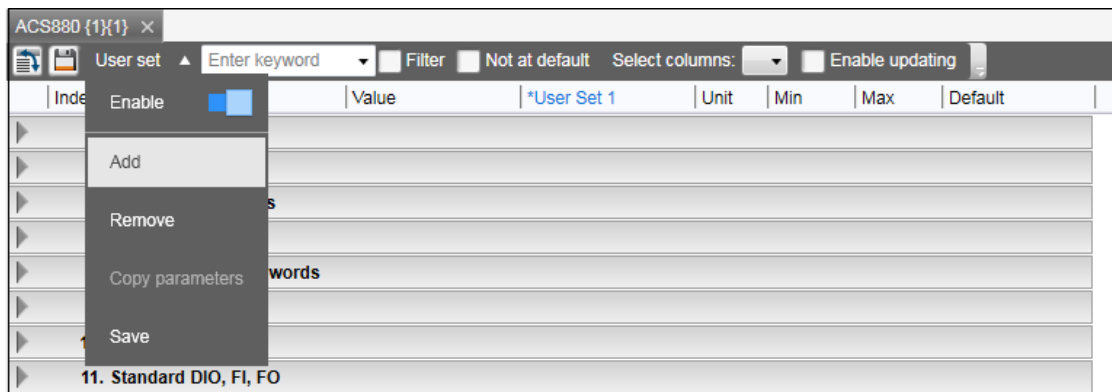

2. From the user set options, select the appropriate option and click **OK**.

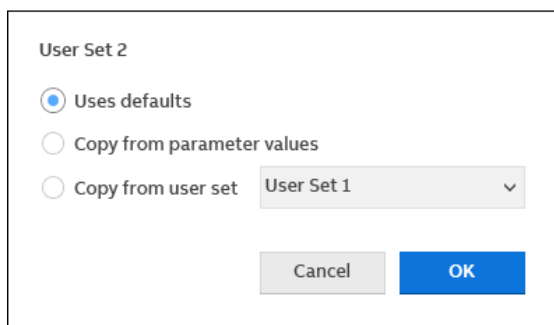

- Uses defaults—takes the parameter values from defaults
- Copy from parameter values—copies the current parameter values
- Copy from user set—copies from another user set.

The new user set is displayed in the parameter window.

Note: If the maximum number of supported user sets is reached, the **Add** option is disabled in the user set menu. The maximum number of user sets is determined by the drive firmware. For example, the current virtual drive firmware version 2.82 supports four user sets.

■ Active and unsaved user set

The active user set is highlighted in blue in the header row of the parameter window. To change the active user set, configure parameter *96.11 User set save/load = Load user set X*.

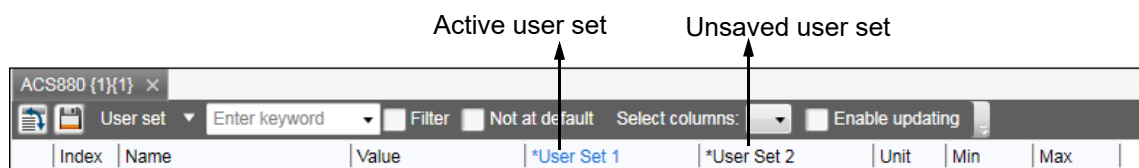

The unsaved user set is highlighted with * symbol in the header row of the parameter window.

■ Saving user set

1. In the User set menu, click **Save**.

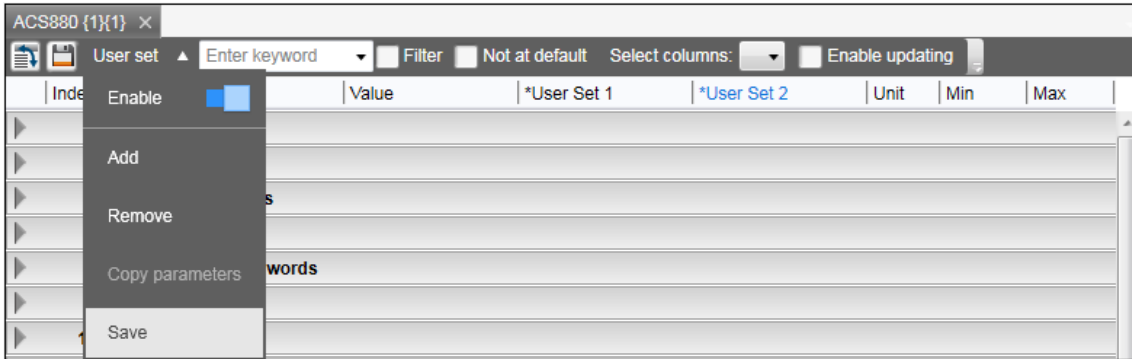

2. User sets are saved. Click **OK**.

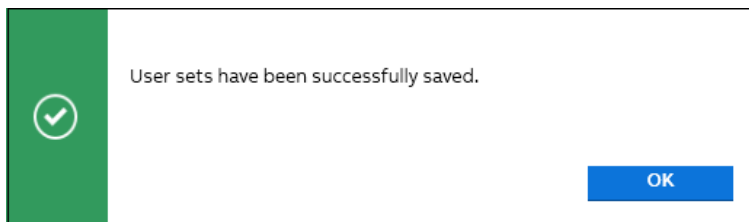

Note:

- When all user sets are saved, the Save option is disabled in the User set menu.
- If there are unsaved user sets at the time of disabling the user set function, closing the parameter window or exiting Drive Composer, a reminder appears to save the unsaved user set(s).
- You can also save user sets using parameter *96.11 User set save/load*. ABB recommends to save user sets using the Save option in the User set menu.

■ Copying user set parameter values

You can copy specific parameter values between user sets.

Note: Parameter(s) in the backup file only can be used as the source of copy operation.

1. In the parameters window, select the parameters to copy.

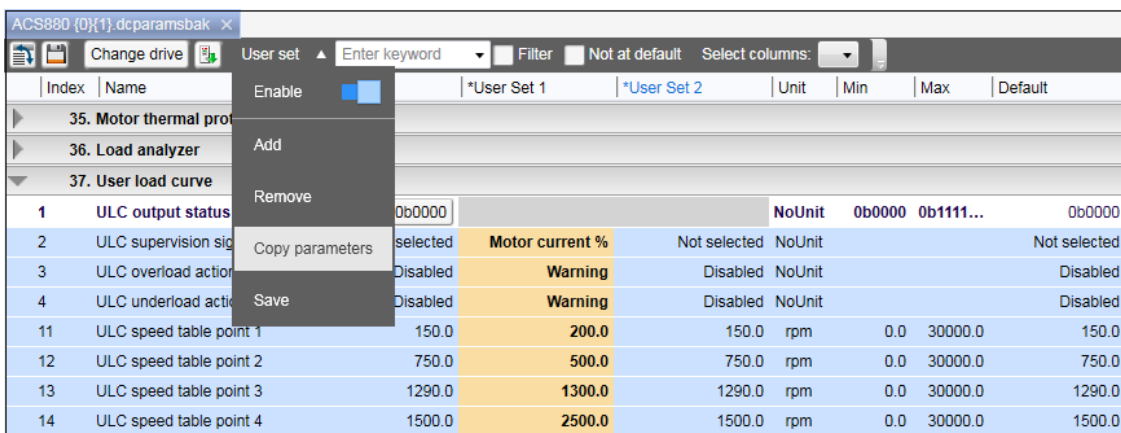

Note: If no parameters are selected, the Copy parameter option will be disabled.

2. In the User set menu, click **Copy parameters**.

- In the Copy parameters window, select the source and destination parameters. Click **OK**.

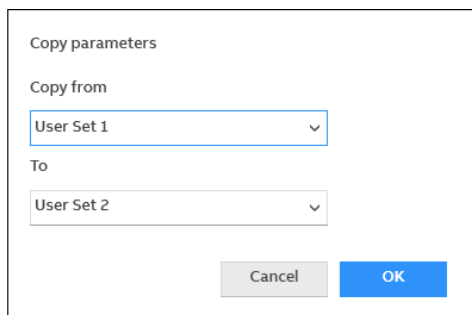

The selected values in User Set1 is copied to User Set2.

Index	Name	Value	*User Set 1	*User Set 2	Unit	Min	Max	Default
36. Load analyzer								
37. User load curve								
1	ULC output status word	0b0000			NoUnit	0b0000	0b1111...	0b0000
2	ULC supervision signal	Not selected	Motor current %	Motor current %	NoUnit			Not selected
3	ULC overload actions	Disabled			NoUnit			Disabled
3	ULC overload actions		Warning	Warning	NoUnit	0	3	Disabled
4	ULC underload actions	Disabled			NoUnit			Disabled
4	ULC underload actions		Warning	Warning	NoUnit	0	3	Disabled
11	ULC speed table point 1	150.0	200.0	200.0	rpm	0.0	30000.0	150.0
12	ULC speed table point 2	750.0	500.0	500.0	rpm	0.0	30000.0	750.0
13	ULC speed table point 3	1290.0	1300.0	1300.0	rpm	0.0	30000.0	1290.0
14	ULC speed table point 4	1500.0	2500.0	2500.0	rpm	0.0	30000.0	1500.0

Removing user set

- In the User set menu, click **Remove**.

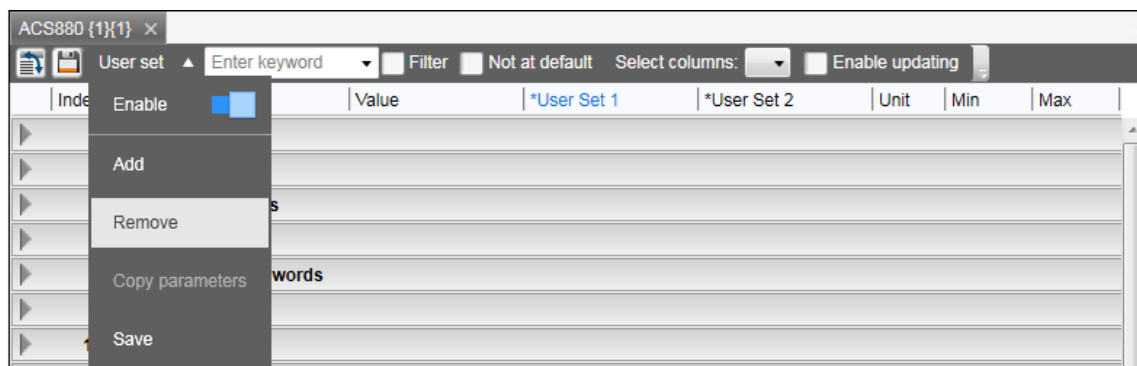

Note: The Remove option is disabled if no user sets are available.

- Select user set(s) to remove and click **Remove**.

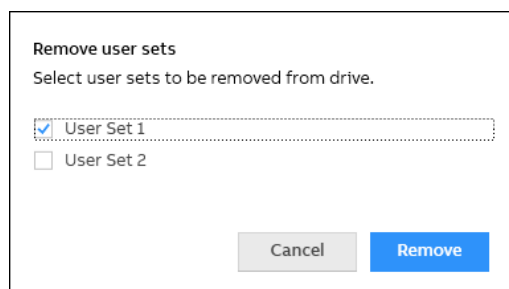

The selected user set is removed.

Show/hide user set

You can show/hide a user set in the columns list.

1. In the Parameter window, click **Select columns**.

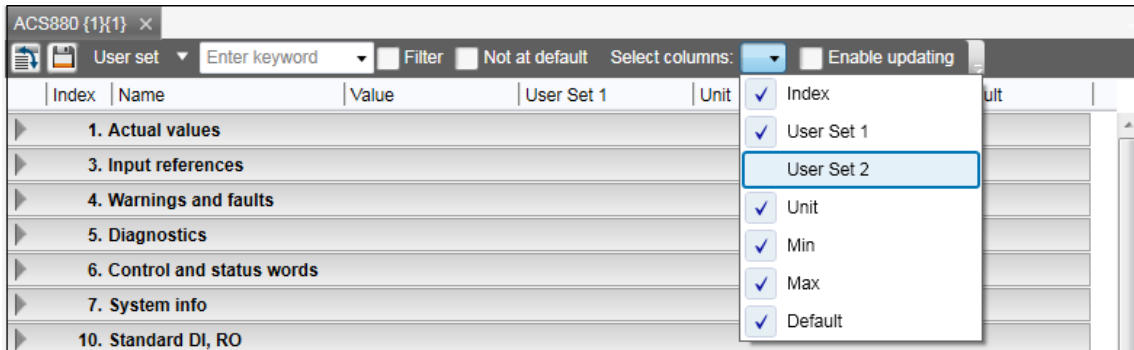

2. Check/uncheck the desired User set to show/hide.

User set parameters limitation

- Parameters not valid for user set are disabled and appears as Grey boxes. For information of invalid user set parameters, see the firmware manual.
- All signal parameters are disabled, by default.

Index	Name	Value	User Set 1	User Set 2	Unit	Min	Max
97. Motor control							
98. User motor parameters							
99. Motor data							
3	Motor type	Asynchronous motor	Asynchronous motor	Asynchronous motor	NoUnit		
4	Motor control mode	DTC	DTC	DTC	NoUnit		
6	Motor nominal current	0.0	0.0	0.0	A	0.0	
7	Motor nominal voltage	0.0	0.0	0.0	V	0.0	
8	Motor nominal frequency	0.00	0.00	0.00	Hz	0.00	1
9	Motor nominal speed	0	0	0	rpm	0	
10	Motor nominal power	0.00			kW	-34028...	34
11	Motor nominal cos φ	0.00	0.00	0.00	NoUnit	0.00	
12	Motor nominal torque	0.000			Nm	0.000	40
13	ID run requested	None			NoUnit		
14	Last ID run performed	None			NoUnit		
15	Motor polepairs calculated	0			NoUnit		0
16	Motor phase order	U V W	U V W	U V W	NoUnit		
18	Sine filter inductance	0.000	0.000	0.000	mH	0.000	100

- User set parameters with different unit/min/max/default values are displayed in different rows.



12

Monitor window

Contents of this chapter

This chapter describes the monitor window and its use.

See topics:

<i>Monitor window overview</i>	137
<i>Resizing the monitor window</i>	138
<i>Adding parameters/signals for monitoring</i>	139
<i>Monitor window components</i>	140
<i>Configuration and control settings</i>	141
<i>Monitor controls</i>	143
<i>Active signal area overview</i>	143
<i>Zooming the graph</i>	144
<i>Panning the graph</i>	144
<i>Legend area functions</i>	145
<i>Graph area functions</i>	146
<i>Double cursor tool</i>	146

Monitor window overview

In Drive Composer you can monitor the operation of connected drives. In the online mode, the monitor window shows signal values in graphical or numerical format. The monitor data can be saved to a file for later use.

With Drive Composer entry you can monitor up to 8 signals.

With Drive Composer pro you can monitor up to 26 signals. If Drive Composer pro is used with an ACS880 drive, it is possible to monitor 1 signal per 1-ms time interval.

The monitor window is always a tabbed window, in other words, there is only one monitor window available.

User-made monitoring settings (selected signals, y-scalings for signals, pen colors, number of grids etc.) are saved by default. In other words, when you open the tool, there are always the latest settings available.

■ **Resizing the monitor window**

When you start Drive Composer the monitor window is in the minimized position and you have to lift it in the following way before you can start monitoring.

- You can resize the monitor window by clicking the title bar with the primary mouse button and dragging it upwards.

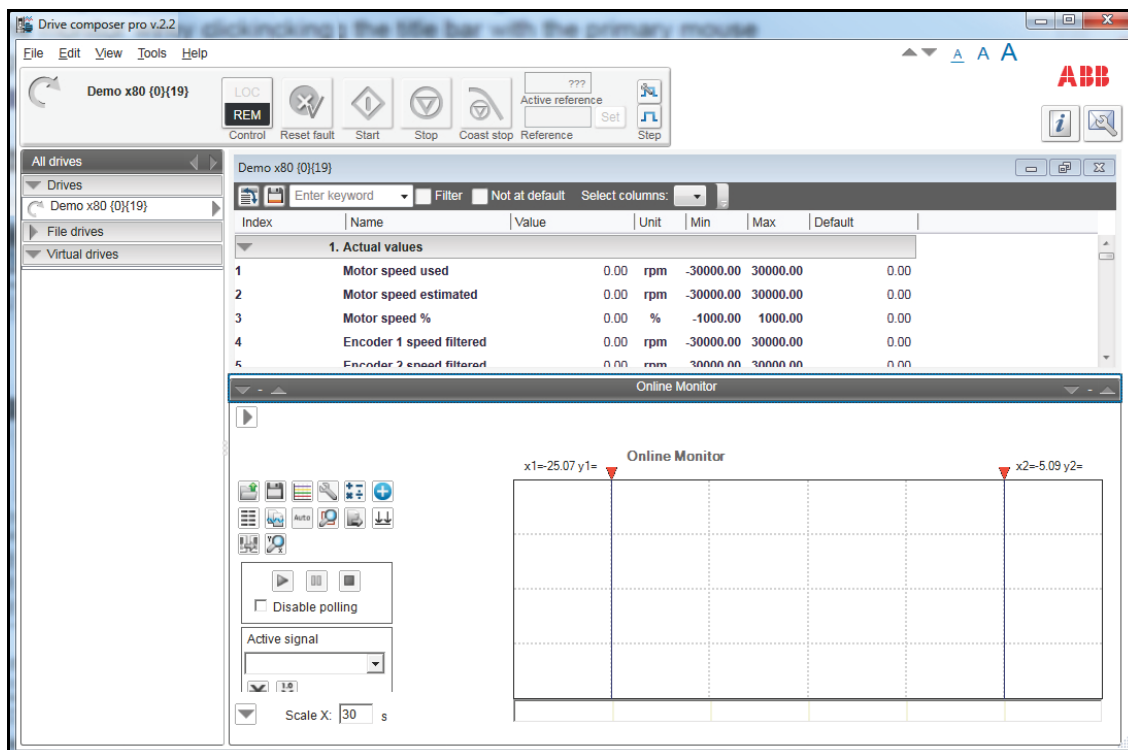

Figure 77. Resizing monitor window

- You can resize the monitor window with the Minimize, Maximize and Split monitor buttons included in the Monitor menu bar.
- You can lift the monitor window by clicking the arrow buttons in the title bar.

Adding parameters/signals for monitoring

There are two ways to add parameters/signals to the monitor window:

- Right-click a parameter/signal in the parameter window and select **Send to monitor**.

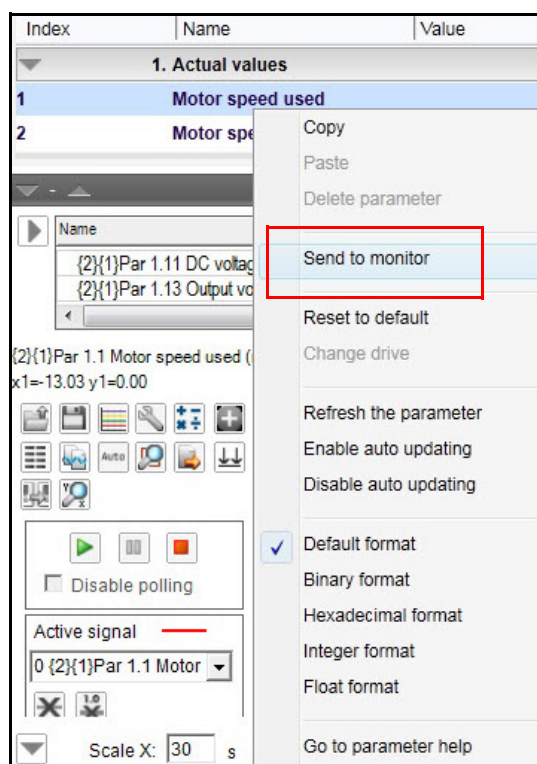

Figure 78. Monitor window: Send to monitor command

- Click the **Add signal** icon on the configurations and control area in the monitor window.

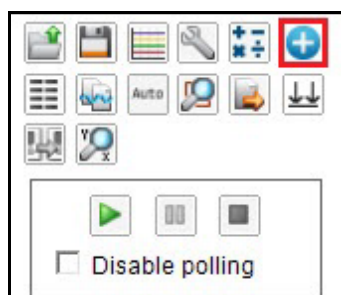

Figure 79. Monitor window: Configuration and control area icons

Select parameters from the Drive parameters list by double-clicking them or select a parameter and click **Add** button. You can add maximum of 26 parameters in Drive Composer pro and eight parameters in Drive Composer entry.

Note:

- With Drive Composer pro you can select signals/parameters from different drives. Change the drive from the Drive list as shown in the following figure.
- In the PC tool network via Ethernet or with a panelbus, ABB recommends you to select **Disable polling** to enable the best sampling result for monitoring. The status of the drive(s) cannot be read before you have unselected **Disable polling**.

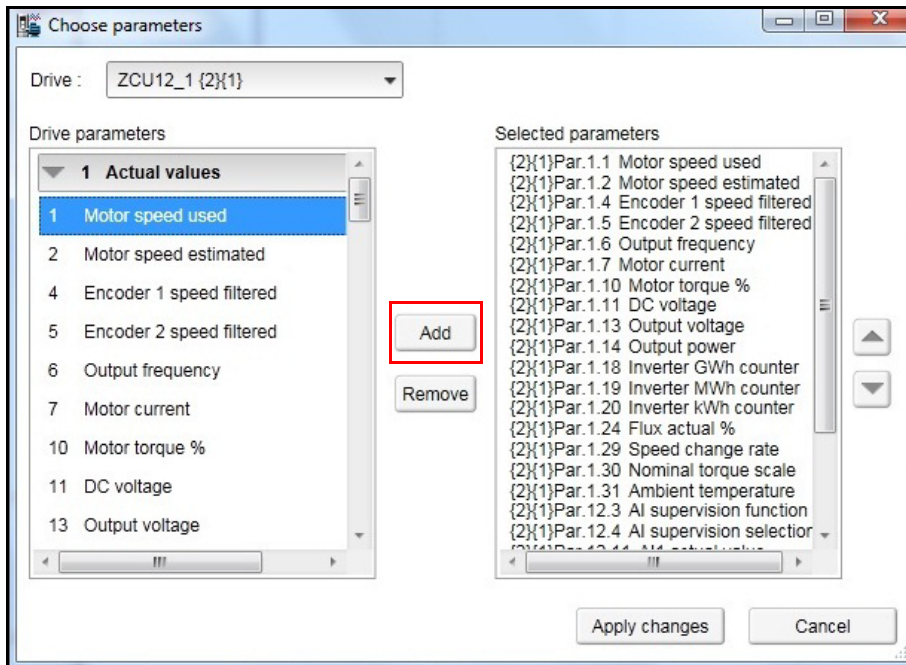

Figure 80. Monitor window: Drive list

The selected signals appear in the legend area.

To change the scalings of the y-axis of selected parameters/signals, click the Min or Max column in the legend area.

Active signals can be changed from the pull-down menu on the left side of the graph area.

All the other signal scalings are performed on the right side of the legend area. The right side y-scalings can be hidden by removing the check mark from the Y-scale column check box.



Figure 81. Monitor window: Changing pen color and style in the legend area

You can change the color and thickness of the pen only after you have minimized, that is hidden the legend area with the **Arrow** button on the left (see the figure above).









To change the scalings of the y-axis for selected parameters/signals, click the Min or Max column in the legend area.





■ Monitor window components

The monitor window consists of the following parts:



- Configuration and control settings
- Graph area
- Y-axis
- X-axis
- Legend area
- Limit, color settings.

Configuration and control settings

Icon	Description																																																						
	<p>Opens the saved monitored file to the graph area, which can be done only after monitoring has been stopped. File extension is *.dcemon or *.dcpmon.</p> <p>Note: If you have an online connection and want to start a new monitoring session after viewing opened monitored data, you can click the Monitor configuration icon.</p>																																																						
	<p>Saves the accumulated monitor data to a monitored data file. File extension is *.dcemon for the entry version and *.dcpmon for the pro version.</p>																																																						
	<p>Chart configuration can be used to set the colors for grids, number of grids, background color, color of alarm pen etc.</p>																																																						
	<p>Opens the Monitor settings window where you can modify the monitor settings and the select the sample interval time for monitoring. You can also set the method for starting and/or stopping monitoring (by hand/time). You have to select the HD where the saved data is stored.</p> <p>Note: The monitored data is saved cyclically to the selected file.</p> <p>Created monitoring configuration can be saved and restored from Monitor settings window.</p>																																																						
	<p>Allows you to create an arithmetic signal for monitoring by using two signals used in monitoring. Available operations are ADD, SUB, MUL and DIV.</p> <div data-bbox="409 1048 1419 1579" style="border: 1px solid gray; padding: 5px;"> <p>Arithmetic signals</p> <p>Select new signal</p> <table border="1" style="width: 100%; border-collapse: collapse;"> <tr> <td style="width: 40%;">Signal 1 {1}{1}Par 25.2 Speed proportional gain (NoUni)</td> <td style="width: 15%; text-align: center;">Operator ADD</td> <td style="width: 45%;">Signal 2 {1}{1}Par 5.1 On-time counter (days)</td> </tr> <tr> <td>Signal name Test 1</td> <td style="text-align: center;"> <div style="border: 1px solid gray; padding: 2px;"> ADD SUB MUL DIV </div> </td> <td></td> </tr> </table> <div style="text-align: right; margin-top: 5px;"> <input type="button" value="Add to list"/> </div> <table border="1" style="width: 100%; border-collapse: collapse; margin-top: 5px;"> <thead> <tr> <th>Signal name</th> <th>Factor 1</th> <th>Operand</th> <th>Factor 2</th> </tr> </thead> <tbody> <tr><td> </td><td> </td><td> </td><td> </td></tr> <tr><td> </td><td> </td><td> </td><td> </td></tr> <tr><td> </td><td> </td><td> </td><td> </td></tr> <tr><td> </td><td> </td><td> </td><td> </td></tr> <tr><td> </td><td> </td><td> </td><td> </td></tr> <tr><td> </td><td> </td><td> </td><td> </td></tr> <tr><td> </td><td> </td><td> </td><td> </td></tr> <tr><td> </td><td> </td><td> </td><td> </td></tr> <tr><td> </td><td> </td><td> </td><td> </td></tr> <tr><td> </td><td> </td><td> </td><td> </td></tr> <tr><td> </td><td> </td><td> </td><td> </td></tr> </tbody> </table> <div style="text-align: right; margin-top: 5px;"> <input type="button" value="Remove selected"/> </div> <div style="display: flex; justify-content: space-between; margin-top: 5px;"> <input type="button" value="Apply"/> <input type="button" value="Close"/> </div> </div> <p>Note: Remember to save settings in a workspace.</p>	Signal 1 {1}{1}Par 25.2 Speed proportional gain (NoUni)	Operator ADD	Signal 2 {1}{1}Par 5.1 On-time counter (days)	Signal name Test 1	<div style="border: 1px solid gray; padding: 2px;"> ADD SUB MUL DIV </div>		Signal name	Factor 1	Operand	Factor 2																																												
Signal 1 {1}{1}Par 25.2 Speed proportional gain (NoUni)	Operator ADD	Signal 2 {1}{1}Par 5.1 On-time counter (days)																																																					
Signal name Test 1	<div style="border: 1px solid gray; padding: 2px;"> ADD SUB MUL DIV </div>																																																						
Signal name	Factor 1	Operand	Factor 2																																																				
	<p>Opens a dialog where you can add or remove one signal or several signals from the monitor configuration.</p> <p>Note: You can use the Add signal function only when monitoring has been stopped.</p>																																																						
	<p>Shows the signal values in text format. Only the values seen in graph area are included in the numeric signal value list.</p>																																																						
	<p>Copies the monitoring graph to a clipboard.</p>																																																						
	<p>Scales the y-axis automatically.</p> <p>Note: Zooming is not possible in the Autoscaling mode.</p>																																																						

Icon	Description
	Resets both x- and y-axis zooming to original 100%.
	You can export the monitored data in csv format to a PC. Exported data can analyzed with other tools. Use the Tab key for delimiting the columns. File extension is *.dcexp.
	Aligns signals.
	Selects or changes the drive.
	Zooms in the x- and/or y-axis up to 1000%.

Monitor controls

Icon	Description
	Starts recording data in the selected drives and displaying it on the screen.
	Pauses monitoring on the screen but monitoring continues on the background. When you click the Pause icon again, all values are seen and monitoring continues normally.
	Stops recording data in the selected drives. The graph or numerical values remain on the screen. The graph can be saved for later purposes.

Active signal area overview

The Active signal area consists of functions that can be done with the selected active signal. The signal can be changed from the pull-down menu.

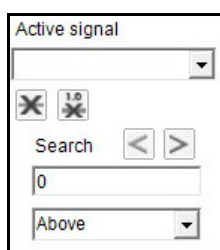





Figure 82. Monitor window: Active signal area

The main functions are the following:

Icon	Description
	Allows you to see the measuring points of the active signal. See figure Monitor window: Measuring points for active signal . Note: This functionality works only if you have zoomed in enough in the graph area, that is, if the length of the x-axis is short enough.
	Allows you to see the numeric values of the measuring points for the active signal. See figure Monitor window: Measuring points for active signal . Note: This functionality works only if you have zoomed in enough in the graph area.
	Searches to the left. The following search conditions can be selected from the pull-down menu: Above, Below or Either. See figure Monitor window: Search functionality .
	Searches to the right. The following search conditions can be selected from the pull-down menu: Above, Below or Either. See figure Monitor window: Search functionality .

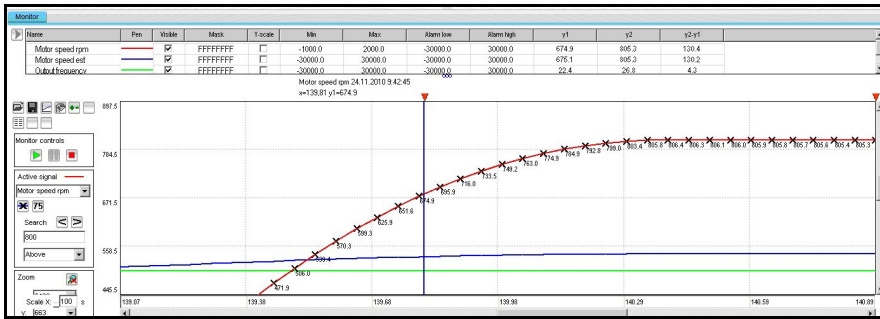

Figure 83. Monitor window: Measuring points for active signal

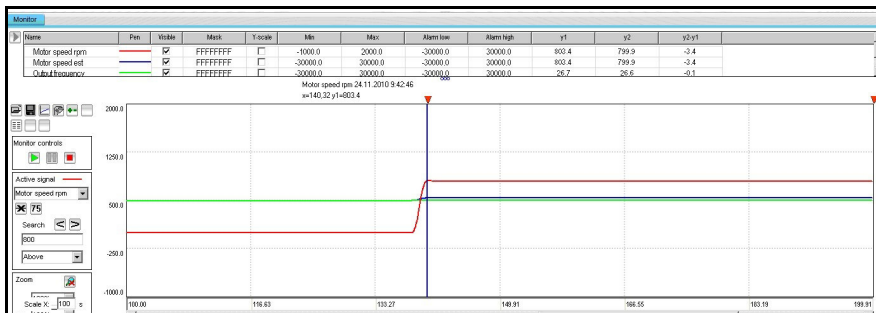

Figure 84. Monitor window: Search functionality

Zooming the graph

To enlarge the graph and take a closer look at the details, follow these steps:

1. To set the starting corner for the enlargement, place the mouse cursor in the graph area and press down the primary mouse button.
2. Drag to the opposite desired corner, and release the button.
The part of the graph that was inside the selection rectangle zooms out to fill the graph area.
3. To reset the zoom tool, click the **Reset zoom** icon.

You can also use the zooming tool by selecting independent values from x and y pull-down menus.

Note: Monitoring is paused during zooming. To continue monitoring, click the **Reset zoom** icon shown in the figure below.

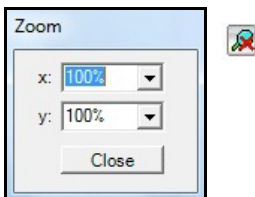

Figure 85. Monitor window: Zoom tool

Panning the graph

The graph can be panned by dragging the graph with the right mouse button pressed down.

Legend area functions

The legend area shows selected signals. You can perform the following actions in the legend area:

- Change the color of the pen, thickness and style of the pen by minimizing the legend area and setting the values of each signal. See figure [Monitor window: Legend area functions](#).
- Make signals visible or invisible by clicking the check box in the Visible column.
- Set a bit mask for monitoring. When you double-click the value in the Mask column, a new window opens allowing you to select bits for monitoring.
- Make Y-scalings visible or invisible by clicking the check box in the Y-scale column.
- Set values for y-axis scaling. You can modify the minimum and maximum values by clicking them and entering a new value. Press Enter to enforce the new value or press Esc to restore the value.

Note: If you do not see immediate changes in the graph area, check that autoscaling is not enabled.

- Set alarm limits for monitored signals. The color of a signal changes when the limit in the Alarm low or Alarm high column is reached. The color and style for the pen are selected from **Chart settings**.
- See the double cursor tool, y1 and y2 values and y2—y1 and x2—x1 differences.



Name	Pen	Visible	Mask	Y-scale	Min	Max	y1	y2	y2-y1	x2-x1	Alarm low	Alarm high
[2]{1}Par 1.5 Encoder 2 speed filtered (rpm)		<input checked="" type="checkbox"/>	FFFFFFFF	<input checked="" type="checkbox"/>	-30000.00	30000.00	-	-	-	-	10000.0	30000.00
[2]{1}Par 1.6 Output frequency (Hz)		<input checked="" type="checkbox"/>	FFFFFFFF	<input checked="" type="checkbox"/>	-500.00	500.00	-	-	-	-	-500.00	500.00
[2]{1}Par 1.7 Motor current (A)		<input checked="" type="checkbox"/>	FFFFFFFF	<input checked="" type="checkbox"/>	0.00	30000.00	-	-	-	-	0.00	30000.00

Figure 86. Monitor window: Legend area functions

Graph area functions

The monitor window and data logger window have similar graph area facilities for displaying signal values. Their usage is described here. Before Drive Composer starts monitoring online, the OnLine monitor text is seen in the graph area. When monitor files are viewed, the DataFile Viewer text is seen in the monitor window.

The graph area shows the selected signal values with different colors. The x-axis represents Time and can be set from 1 to 120s. You can change the values in online monitoring mode. Scalings of the y-axis are changed in the legend area.

For data logger files, an orange arrow-head on the x-axis indicates where triggering has occurred. Data can be combined from several files to one graph.

■ Double cursor tool

With the cursor tool, you can see the exact values of the signals at two positions in the graph area. You can move the position of cursors by clicking the primary mouse button down on the red cursor tool icon and moving it. While the mouse button is pressed down, you can move the cursor line to the left and right.

The time stamp of the cursor tool is shown in the header of the cursor tool. This is shown for the active signal. The time stamp changes if active signal is changed. The values for y1 and y2 are shown in the legend area. Signal value differences are shown in the column y2—y1. The time difference for x2—x1 is also shown in the figure below.

Name	Pen	Visible	Mask	Y-scale	Min	Max	y1	y2	y2-y1	x2-x1	Alarm low	Alarm high
{2}{1}Par 1.5 Encoder 2 speed filtered (rpm)		<input checked="" type="checkbox"/>	FFFFFFFF	<input checked="" type="checkbox"/>	-30000.00	30000.00	-	-	-	-	10000.0	30000.00
{2}{1}Par 1.6 Output frequency (Hz)		<input checked="" type="checkbox"/>	FFFFFFFF	<input checked="" type="checkbox"/>	-500.00	500.00	-	-	-	-	-500.00	500.00
{2}{1}Par 1.7 Motor current (A)		<input checked="" type="checkbox"/>	FFFFFFFF	<input checked="" type="checkbox"/>	0.00	30000.00	-	-	-	-	0.00	30000.00

{2}{1}Par 1.1 Motor speed used (rpm) 1/29/2014 1:51:21 PM x1=25.05 y1=-	{2}{1}Par 1.1 Motor speed used (rpm) 1/29/2014 1:51:41 PM x2=5.06 y2=-
--	---

Figure 87. Monitor window: Double cursor tool

12

Workspace handling

Contents of this chapter

This chapter describes the workspace functionality.

See topics:

Workspace overview

<i>Workspace overview</i>	137
<i>Creating a custom parameter set and using it as a default workspace</i>	138

Workspace consists of the user interface status, such as parameter windows and custom parameter windows.

The current workspace status can be saved to a file and restored later.

Note:

- You cannot save/restore the following status data:
 - drive control status
 - If a drive is controlled locally with Drive Composer when the workspace is saved, the workspace is saved without the change in the drive control status.
 - content, status and zooming levels of a stopped, paused or running monitor.
 - Do not edit a workspace or graph file. The workspace (*.dcxml*) and monitored data (*.dcmom*) files can contain binary data. For example, if the default workspace file is corrupted, Drive Composer does not open. If Drive Composer does not open, delete your default (*.dcxml*) file from the PC and open Drive Composer again.
-

Creating a custom parameter set and using it as a default workspace

1. Make a connection to a drive.
2. Resize the monitor window to half of the screen.
3. Create a new custom parameter window by clicking **File** → **New..** → **Custom parameter set** and name it “Own limit window”.

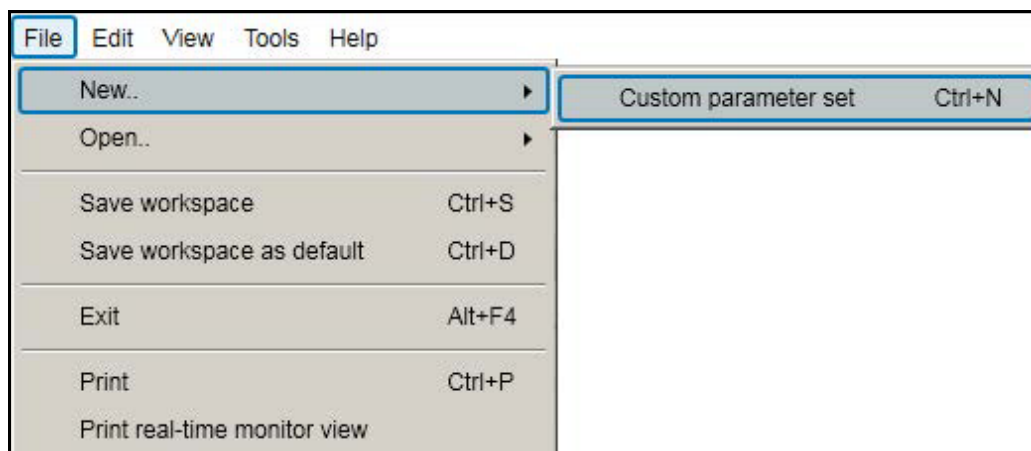

Figure 88. Creating workspace: Custom parameter set

4. In the File menu, click **Save workspace** to save the workspace.
5. Create another custom parameter window and name it “Own reference window”.
6. Select floating windows by clicking **View** → **Floating windows**.
7. Enter keyword “Limit” in the Enter keyword field of the main parameter window.
8. Select parameters in the main parameter window and drag and drop or copy them to custom parameter window Limit.
9. Clear the search result and enter keyword “ref” in the Enter keyword field.
10. Select parameters in the main parameter window and drag and drop or copy them to custom parameter window Own reference window.
11. Close the main parameter window.
12. Click **Event logger** icon in the drive list on the left.

13. Click **File** → **Save workspace** and name it “OwnWorkspaceFor_ACS880”.

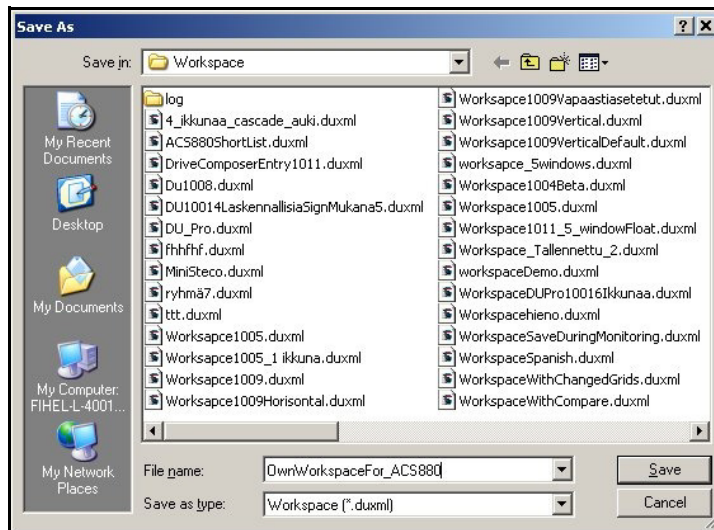

Figure 89. Creating workspace: Name your workspace

14. Close the connection to the drive and make a new connection.
15. Click **File** → **Open..** → **Open workspace** and open the workplace that you have saved.

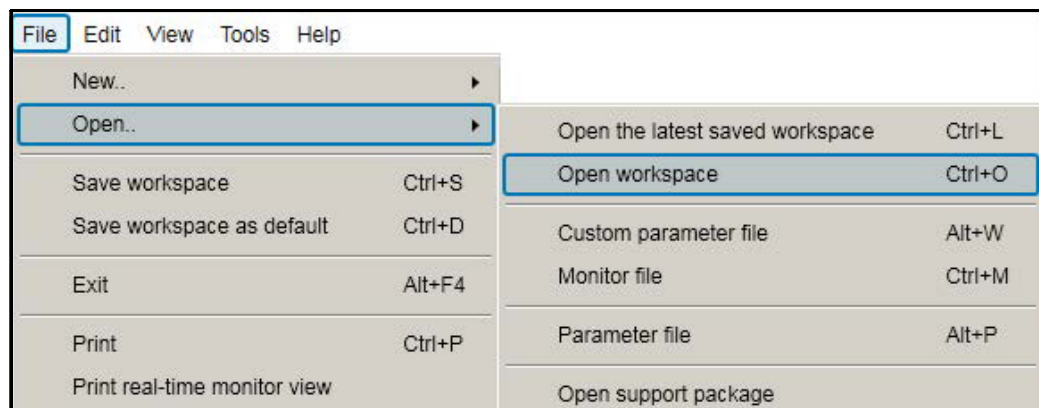

Figure 90. Creating workspace: Open workspace command

The workspace is ready to use for commissioning and maintaining drives.

The workspace can also be saved as a default workspace which opens automatically when Drive Composer is started.

12

Event logger

Contents of this chapter

This chapter describes the event logger and fault data logger view and its use.

See topics:

<i>Event logger view</i>	137
<i>Fault data logger</i>	139

Event logger view

The event logger view displays the event logs of a connected drive. The event logs can be faults (stopping the drive), alarms or events. With some drives there can be more data of a fault in the monitor window.

Note: Fault logger data can also be seen from other faults than the latest active faults.

1. In the drive list, click on a connected drive and select **Event logger**.

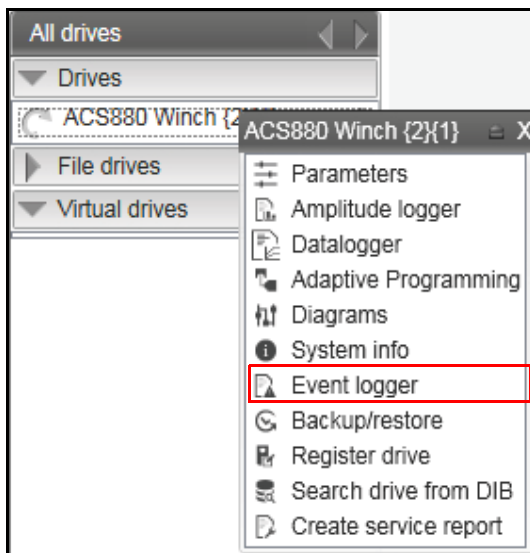

Figure 91. Event logger

The event logs of the connected drive appears in a separate tab.

Time	Type	Fault code	Description	AUX code	AUX code infr	Fault data monitor file	Fault extra data
31.01.2020 16:25:54.467		5681	PU communication	00000006			
31.01.2020 16:25:54.416		A5EA	Measurement circuit temperature	000000FA			
31.01.2020 16:25:54.414		A6A5	No motor data				
31.01.2020 16:25:54.343		A6A6	Supply voltage unselected				
31.01.2020 16:25:53.366		5093	Rating ID mismatch	00000008			
31.01.2020 16:25:51.294		64FF	Fault reset				
31.01.2020 16:25:51.294		B5A2	Power up				
31.01.2020 16:17:35.447		5681	PU communication	00000006			
31.01.2020 16:17:35.396		A5EA	Measurement circuit temperature	000000FA			
31.01.2020 16:17:35.392		A6A5	No motor data				
31.01.2020 16:17:35.321		A6A6	Supply voltage unselected				

Figure 92. Event logger view

The event logger always relates to a single drive and resides in its window.

The Icon column shows the following alarm and fault icons:

Icon	Indicates...
Red circle with white cross (x)	drive has a fault
Yellow triangle with exclamation mark (!)	drive has an alarm
or Grey circle/triangle	fault or alarm has disappeared from the drive

The time stamp for faults, alarms and events comes from the drive.

You can view the sorted list of faults, alarms and events by clicking the header of the Fault column.

Fault data logger

The **Fault data** icon  in the Event logger view shows that the drive has fault data that can be seen with a monitor component. The icon is visible only if the drive sports the functionality.

1. In the Event logger window, click on the  icon.
The message “Please wait. Loading fault data” appears. The data is loaded after the message box disappears.

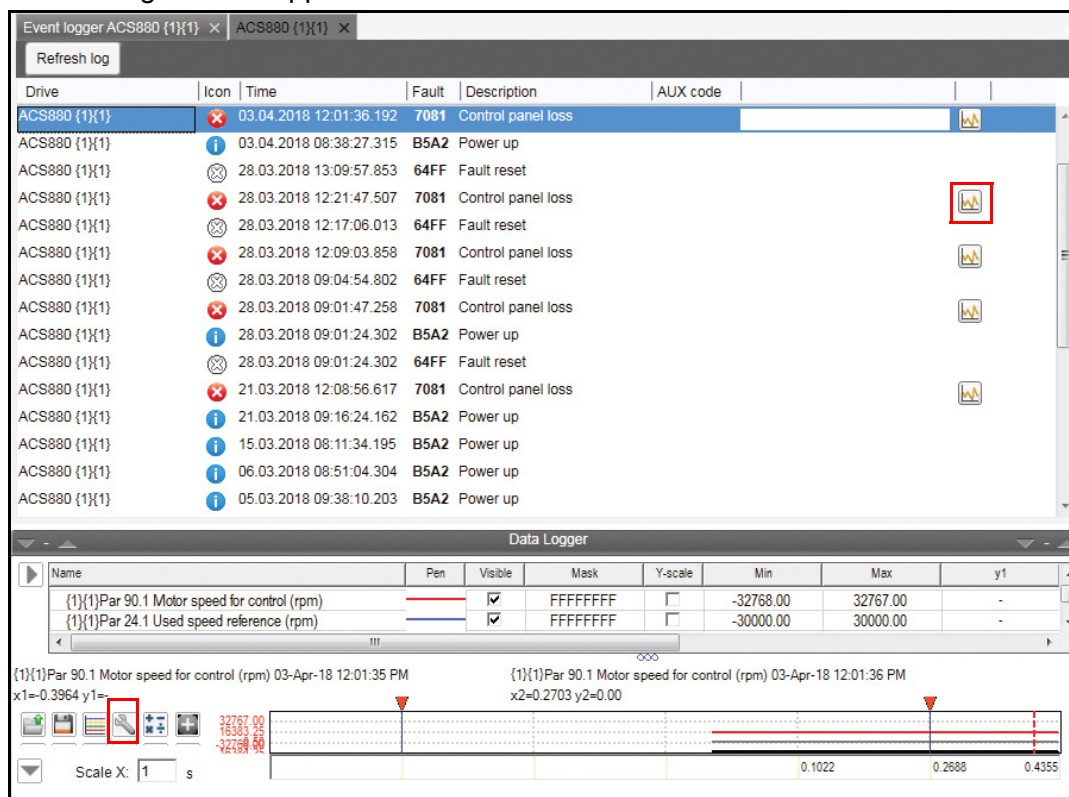

Figure 93. Fault data logger in the monitor window

2. When Drive Composer prompts to save the fault data, click **Yes**.
3. Give a file name for the monitor file.
The file is saved with `.dcpmon` extension.

Note: You can continue the normal monitoring by clicking the **Monitor configuration**  icon in the Monitor controls box of the Data Logger window.

The message “This operation will change monitor into measuring mode and restore the last used configuration. Data on display will be lost. Do you want to continue” appears.

If you clicked Yes, the monitor settings window appears. Select necessary settings and click **OK**.

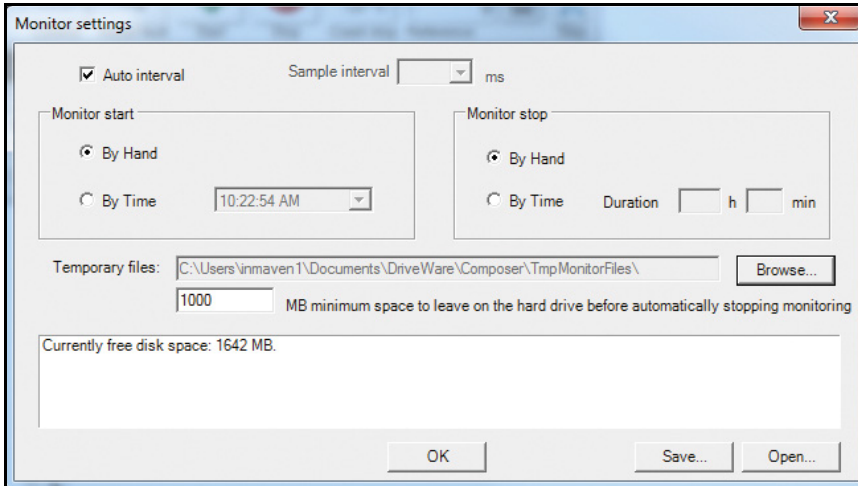

Figure 94. Event logger: Monitor settings window

12

Diagnostics

Contents of this chapter

This chapter describes how to troubleshoot a drive with the **Support package** button of Drive Composer and a Datalogger included in the drive. It also includes how to register an ABB drive to the Drive Installed Base (DIB) portal and create service reports.

See topics:

<i>Support package</i>	138
<i>Drive application programming license</i>	139
<i>System info</i>	140
<i>Datalogger (pro)</i>	140
<i>Amplitude logger (pro)</i>	147
<i>Macro (pro)</i>	148
<i>Macro commands</i>	149

Support package

Support package is an offline package file that contains, for example, full parameter backup, system information, and event logger contents. The main purpose is to collect troubleshooting data and send it to the support personnel for analysis.

■ Creating a support package

By clicking the **Support package** button, you can create and save a support package file (.dcsupport format). You can also do this function from **Help** → **Make support package**.

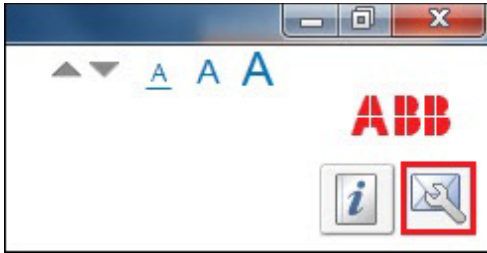
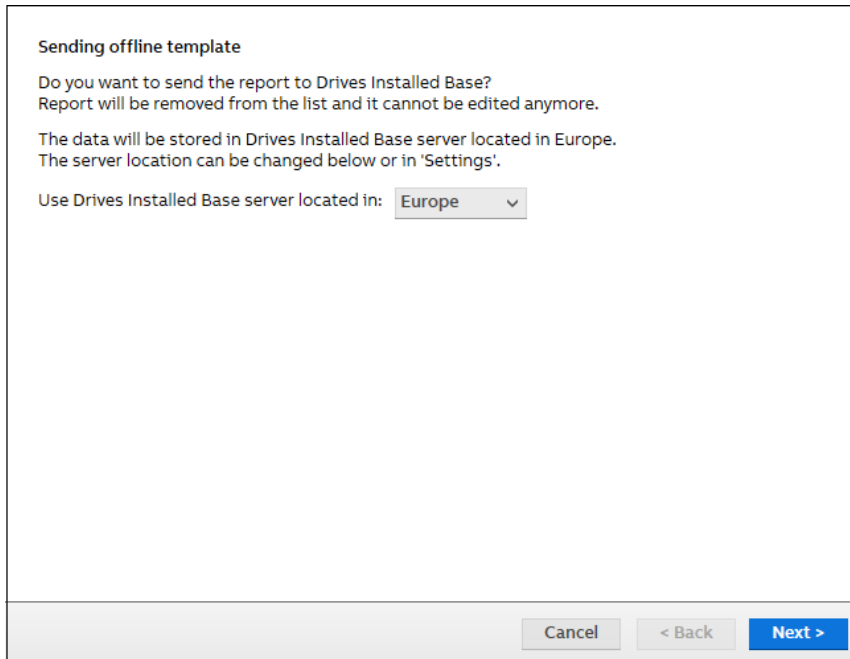

Figure 95. Support package button

■ Sending a support package to Drive Installed Base

After you saved the support package file (.dcsupport) in your PC, Drive Composer prompts to send the package to Drive Installed Base. Select the server location and click **Next**.



If package is sent, in the completed message window, click **OK**.

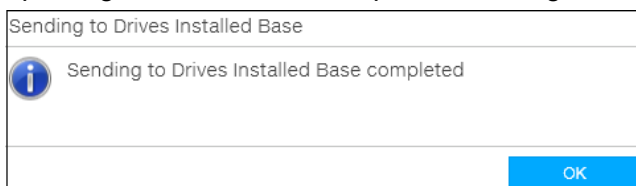

■ Opening a support package (pro)

You can open a Support package file in Drive Composer pro by selecting **File** → **Open** → **Open support package**, a new **File drive** appears. There is similar menu available with online drives.

For further information on each module, see section [System info](#) on page 140, chapters [Parameter window](#) on page 137 and [Event logger](#) on page 137.

Drive application programming license

The drive application programming license N8010 is required for downloading and executing the program code on the ACS880 drive. In DriveComposerPro, select **System info** tab. Check if the appropriate license is loaded to the drive. If the required license code is not available, contact your local ABB representative.

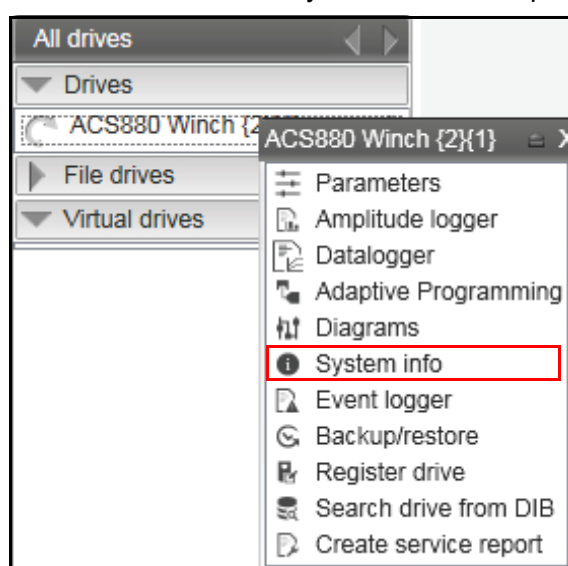

Figure 96. System info command

System info

The System info tab provides basic information about the drive and its options, for example, drive type code and firmware version. You can also check the status of Service pack installation. See [Checking the status of Service pack](#) (page 195).

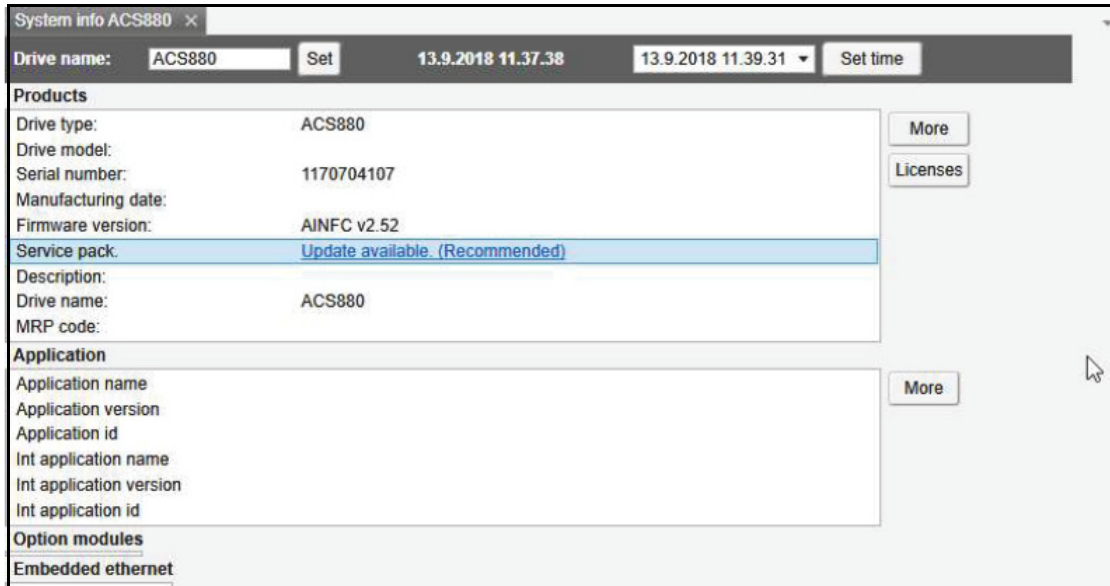

Figure 97. System info

You can also set the time for the drive and name the drive.

Datalogger (pro)

ABB drives have Datalogger(s) that can record data from various signals of a drive even if the drive is not connected to a PC. A Datalogger is operated with the Datalogger view.

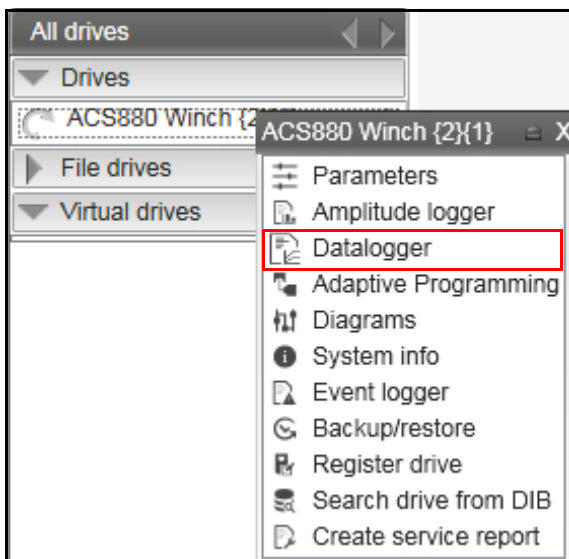

Figure 98. Datalogger configuration

The data collecting can be stopped with a specific stop command or automatically when a triggering condition is true in the drive. After data collection stops you can read and study the data in Drive Composer pro.

The Datalogger view resembles the monitor window. Normally the Datalogger view provides data from a single drive.

Trigger configuration

Apply Trigger Trigger #1 Signal +

Type Disabled

Triggers

ID	Type	Timelevel	Variable	Level	Hysteresis	Logger	Triggered
Trigger #1	Disabled	-	-	-	-	User logger	
Trigger #2	Disabled	-	-	-	-	User logger	
Trigger #3	Disabled	-	-	-	-	User logger	
Trigger #4	Disabled	-	-	-	-	User logger	





Figure 99. Datalogger view

Datalogger settings

The Datalogger settings window contains the following functions:

- Datalogger commands
- Datalogger content configuration
- Datalogger trigger configuration

Datalogger commands

Button	Description
	Start button records data in the current logger of the drive until Datalogger is triggered or stopped.
	Stop button ends recording immediately without any post trigger recording.
	Trigger button triggers the associated logger in the drive. Trigger Datalogger is displayed in Datalogger status with trigger code 15.
	Upload button moves data from the drive to PC and draws it to the monitor window. Datalogger replaces any previous data in monitor window.
	Apply button applies monitored signal and Datalogger sampling settings.

Datalogger content configuration

With the Datalogger content configuration you can determine which Datalogger of a drive is used.

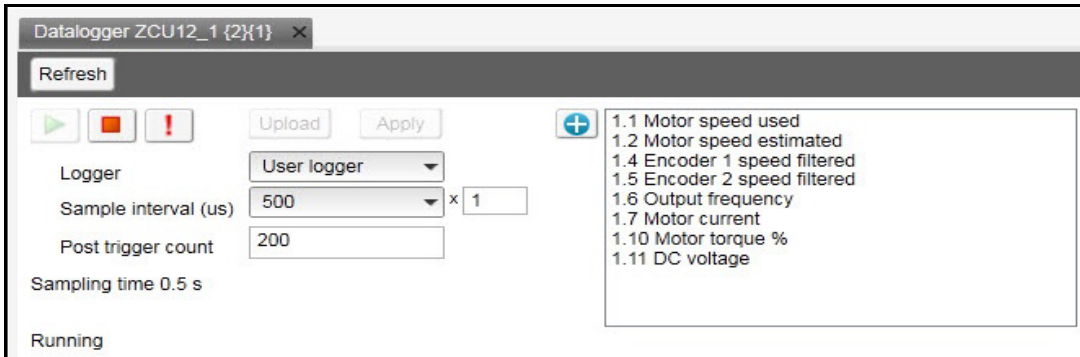



Figure 100. Datalogger content configuration

Datalogger configuration commands	Function
Logger	Determines which logger settings are modified. A drive has user logger(s) and factory logger(s). Factory logger settings cannot be modified.
Sampling interval	Determines in microseconds how often the logger reads samples of the signal values. The time level shows the available lengths of the internal cycle time of the drive. Sample interval is formed from multiplier (1-65535) and time level selection.

Datalogger configuration commands	Function
Post trigger count	Specifies how many samples are stored after the triggering condition occurs when the value is smaller than Datalogger total space count. The Datalogger total space count depends on drive type, selected signal types and total signal count. If the post trigger count value is bigger than Datalogger total space count, the triggering point is not visible anymore in the Datalogger.
Sampling time	Shows the minimum sampling time with a selected number of signals and a selected sample interval.
Logger signals panel	Shows a list of signals selected to record. You can add/remove a signal by clicking the Add signal icon.

To add parameters to the logger, proceed as follows:

1. In the Datalogger screen, click  to add parameters.
2. Select a parameter in the **Drive parameters** list and double-click or click **Add**. The parameter is added to Selected parameters.

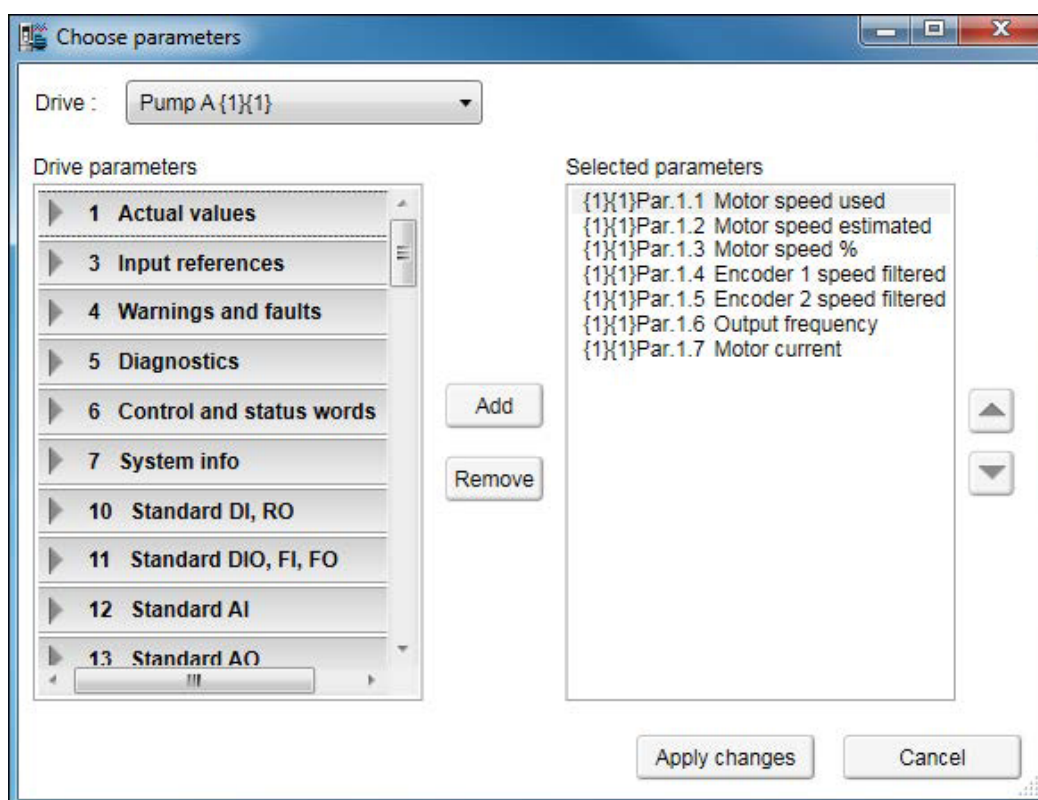

Figure 101. Parameter window

Note: The maximum number of signals that a logger can record at one time depends on the drive. Add button is disabled when maximum number of parameters are reached.

3. To remove the parameter from Selected parameters, select the desired parameter and click **Remove**.
4. Click **Apply changes** after making the changes.

Datalogger trigger configuration

Datalogger has four triggers that can be configured to stop the Datalogger. After Datalogger has triggered, the Datalogger samples post trigger the amount of new samples.

Trigger configuration

Trigger Trigger #1

Type Disabled

Triggers

ID	Type	Timelevel	Variable	Level	Hysteresis	Logger	Triggered
Trigger #1	Disabled	-	-	-	-	User logger	
Trigger #2	Disabled	-	-	-	-	User logger	
Trigger #3	Disabled	-	-	-	-	User logger	
Trigger #4	Disabled	-	-	-	-	User logger	

Figure 102. Datalogger trigger configuration

■ Adding a trigger

1. To modify the conditions of a trigger, select the trigger from the **Trigger** drop-down menu.
Trigger 1 is normally used for user logger 1, Trigger 2 for user logger 2 etc.
2. Choose the type for the triggering condition from the **Type** drop-down menu.
Following are the alternatives (however, not all of them are available at all times):
 - **Bit mask** stops according to the bit mask of the selected signal.
 - **Disabled** can temporarily disable a trigger condition.
 - **Falling edge** level stops according to the selected signal, triggering level and hysteresis values.
 - **Fault** stops when the drive reports a fault.
 - **Event** stops when the drive reports an event.
 - **Rising edge** level stops according to the selected signal, triggering level and hysteresis values.
 - **Warning** stops when the drive reports a warning.
3. If you use Rising edge level or Falling edge level as the type for the triggering condition, see [Using the level triggers](#).
4. Click **Apply**.

Using the level triggers

When condition Rising edge level is used, the function wakes up when the actual value of the triggering signal is below the triggering level - hysteresis. Similarly, when condition Falling edge level is used, the function wakes up when the actual value of the triggering signal is above the triggering level + hysteresis.

Rising edge	<p>Triggering signal is below the triggering level when the Datalogger is started: Triggering occurs when the signal goes above the triggering level.</p> <p>Triggering signal is above the triggering level when the Datalogger is started: Triggering occurs when the signal goes above the triggering level, but before that the signal must go below the triggering level - hysteresis.</p>
Falling edge	<p>Triggering signal is above the triggering level when the Datalogger is started: Triggering occurs when the signal goes below the triggering level.</p> <p>Triggering signal is below the triggering level when the Datalogger is started: Triggering occurs when the signal goes below the triggering level, but before that the signal must go above the triggering level + hysteresis.</p>

Using bit mask trigger

Bit mask trigger reads signal value and masks out user selected bits with given mask. Masking is done by using a logical AND operation. Masked value is compared to user given bit values selection. When masked value and bit values match, Datalogger is triggered.

■ Uploading triggered or stopped Datalogger data

1. In the Datalogger view select a logger from the **Logger** drop-down menu.
If the logger status is stopped or triggered, data can be uploaded.
2. Click **Upload** to upload data to the monitor window.

Note: If you want to continue normal monitoring after using the Datalogger, click **Monitor configuration** icon and select a sampling interval for monitoring.



Figure 103. Continue monitoring after using the Datalogger

3. Click **Add signal** icon to add signals for monitoring.

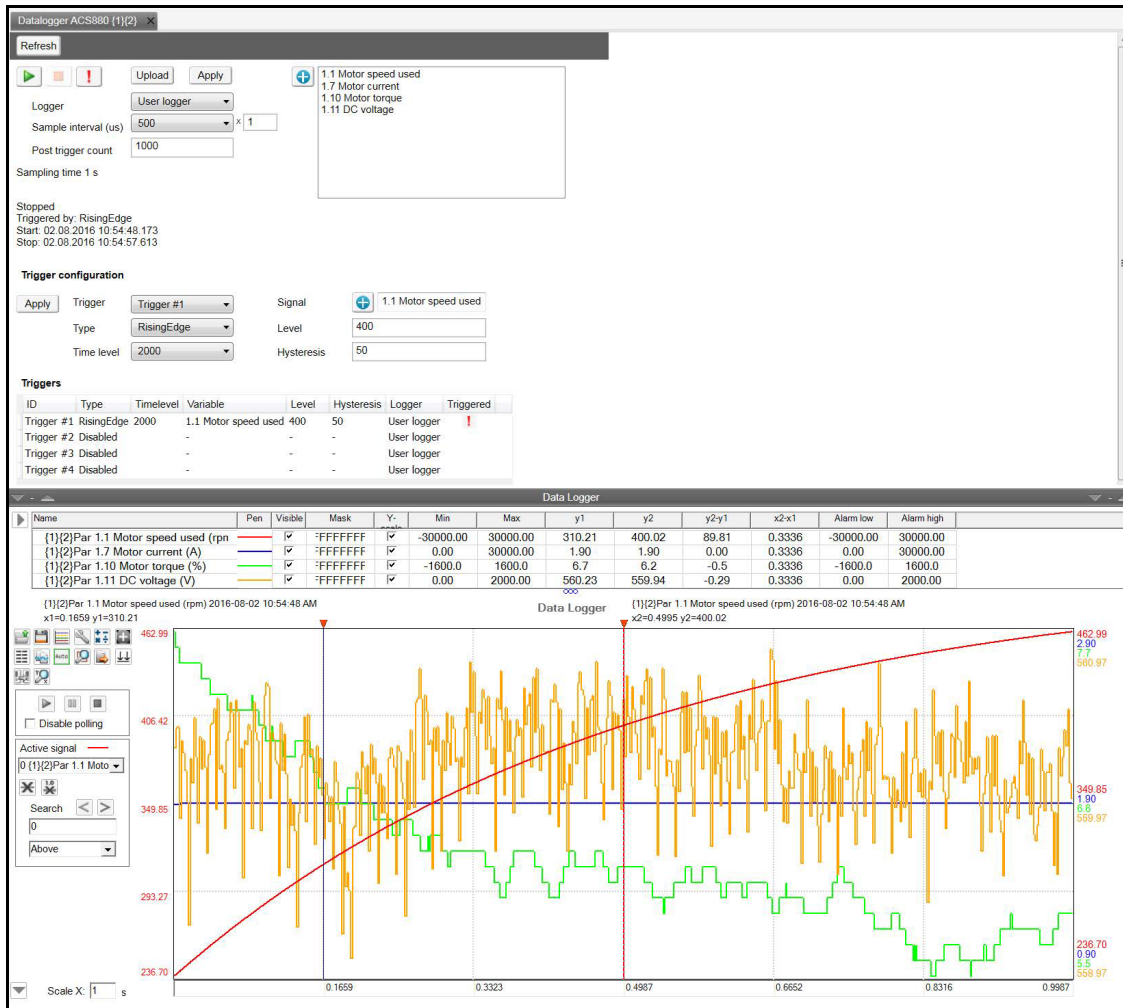

Figure 104. Uploaded Datalogger data

Amplitude logger (pro)

ABB drives have an amplitude logger that can record data from various signals of a drive. The results of an amplitude logger 1 (current) are displayed by the following curve. Each parameter represents an amplitude range and shows what portion of the samples fall within that range.

Note: Dataloggers or amplitude loggers are not available for all ABB drives.

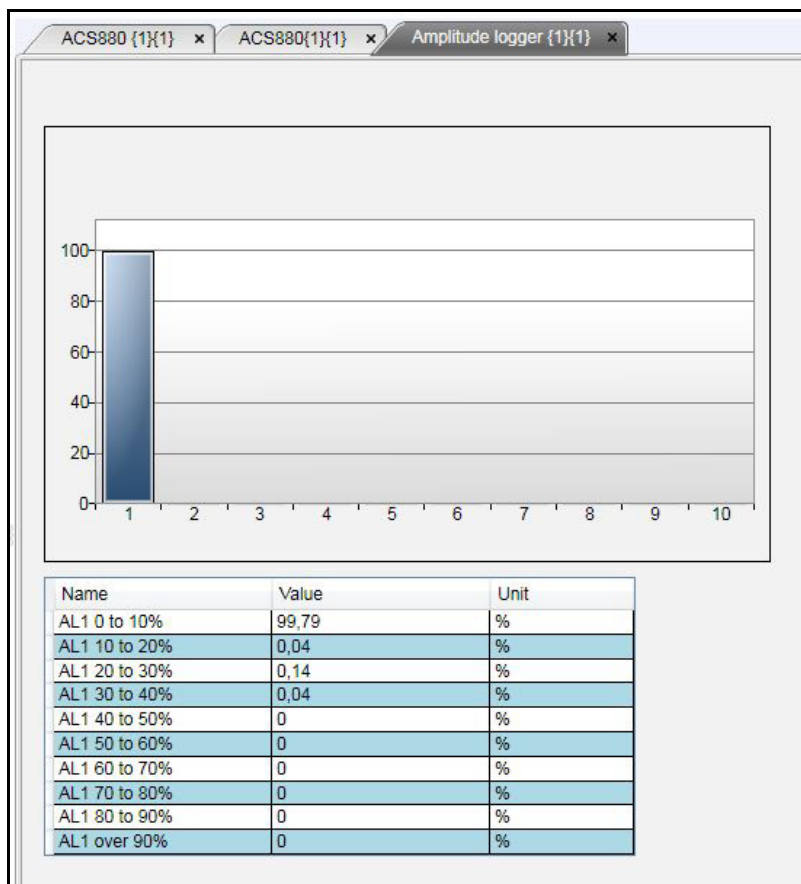

Figure 105. Amplitude logger

Macro (pro)

ABB drives have Macro functionality that can automatize a task or sequence of tasks. You can use macros is set parameter value to multiple networked drives when the Custom window functionality is not sufficient. You can also use macros for tasks which require logical or conditional parameterization of a drive.

- Go to **Tools** → **Macro**.

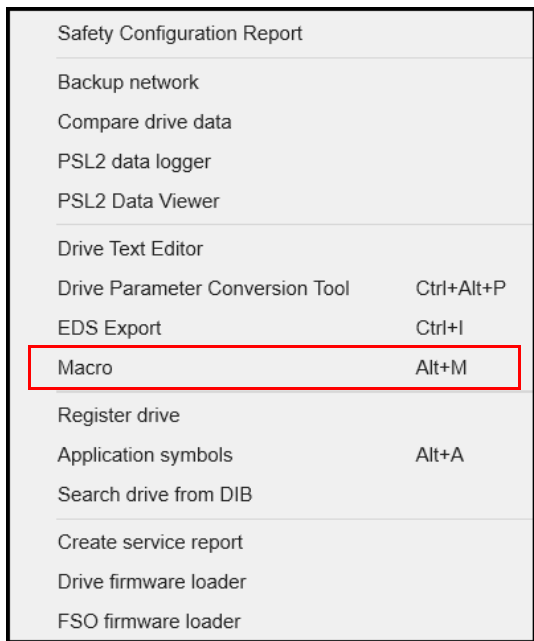

Figure 106. Macro command

A Macro screen is displayed.

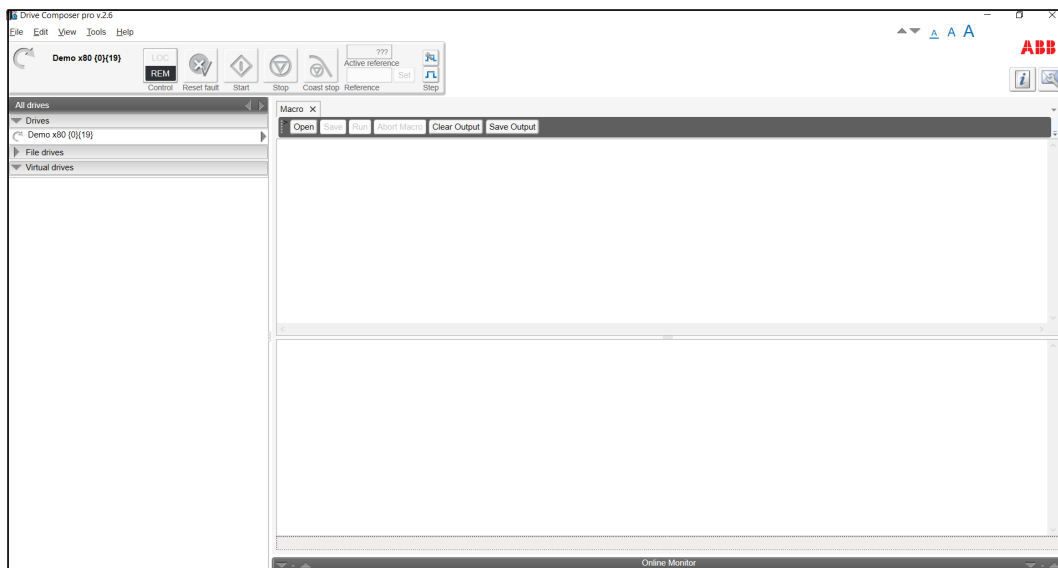

Figure 107. Macro

Macro commands

■ Macro language

Macro language is based on PAWN. For general programming guidelines, refer to *PAWN manual*.

Note: Some PAWN features are disabled for security reasons, such as file operations and other external IO functions.

Simple example

Macro tries to read parameter 1.1 value from each target in 100 network channels.

```
main()
{
    for(new i = 0; i < 100; i++)
    {
        //note the channels are indexed instead of nodes
        // this should be modified according network topology

        //change target
        Target(i+1,1)
        new targetName[100]
        //get target name
        TargetName (targetName)

        //read parameter 1.1 value
        new Float:val0101 = ParRead(1,1);
        //output to console
        printf "%s(%d,%d): %f\n", targetName, 1, 1, val0101 ;
    }
}
```

■ Additional macro commands

Target

Changes the target of the macro command after target command is issued.

Syntax	Returns	Example
Target (Channel, node)	0 if success, 1 if failed	Target (1, 10)

Target name

Command reads the current target name as string.

Syntax	Returns	Example
TargetName (string)	0 if success, 1 if failed	<pre>//reserve name string new name[100] if(TargetName(name)==0) { printf "target name is %s\n" name }</pre>

ParWrite

Command writes parameter value to current target.

Syntax	Returns	Example
ParWrite (group, index, value)	0 if success, 1 if failed	<pre>//write value 1 to group 12 index 16 main () { ParWrite (12, 16, 1) }</pre>

Note: The command does not write pointer or bit pointer type parameter values. Use the ParWriteInt command to write pointer or bit pointer type parameter values.

ParWriteInt

Command writes parameter value to current target.

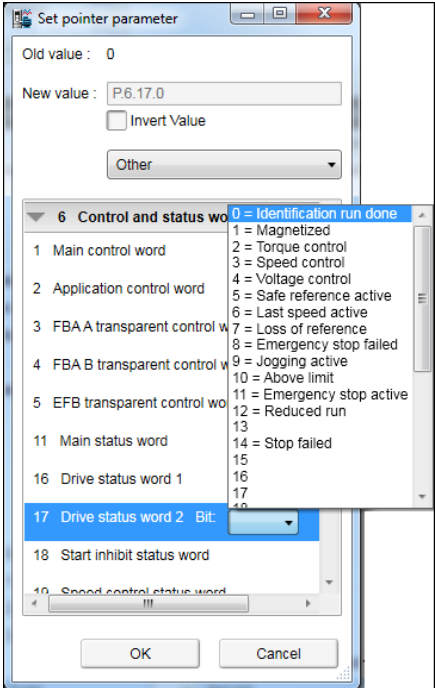
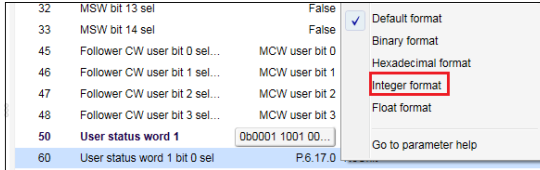
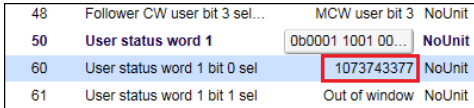
Syntax	Returns	Example
ParWriteInt (group, index, value)	0 if success, 1 if failed. If an error was detected, the error message appears in the log.	<pre>//write parameter 06.17.b0 to parameter 06.60 main () { ParWriteInt (6, 60, 1073743377) }</pre> <p>To get the integer value 1073743377,</p> <ol style="list-style-type: none"> In Drive Composer offline mode, set parameter <i>06.60 User status word 1 bit 0 sel</i> = 06.17.b0  <ol style="list-style-type: none"> Right-click the value and set Integer format.  <p>Value P.6.17.0 appears in integer format as 1073743377.</p> 

ParRead

Command reads the parameter value to current target.

Syntax	Returns	Example
ParRead (group, index)	Parameter value or 0 if failed. If an error is detected, the error message appears in the log.	//Read value of the parameter in group 10 index 5 main () { new Float.val = ParRead(10,5); printf "Value of (%d,%d): %f\n", 10,5, val105; }

Note: The command does not read pointer or bit pointer type parameter values. Use the ParReadInt command to read pointer or bit pointer type parameter values.

ParReadInt

Command reads parameter value to current target from the same source as in the parameters window. The values are cached and refreshed on a notification or every half a second, if you selected the **Enable updating** option in the parameters window. When real time values are required, you can use the command *ParReadIntFromDevice*.

Syntax	Returns	Example
ParReadInt (group, index)	Parameter value casted to integer or 0 if failed. If an error is detected, the error message appears in the log.	//Read value of the parameter in group 7 index 11 main () { new val = ParReadInt (7,11); printf "Value of (%d, %d) : %d\n", 7,11, val; }

ParReadFromDevice

Command reads the parameter value to current target directly from drive.

Syntax	Returns	Example
ParReadFromDevice (group, index)	Parameter value or 0 if failed. If an error is detected, the error message appears in the log.	//Read value of the parameter in group 1 index 11 each second. main() { new Float:val; do { val = ParReadFromDevice(1, 11); printf "Value of (%d,%d):%f\n", 1, 11, val; Wait(1000); } while (1); }

ParReadIntFromDevice

Command reads the parameter value to current target directly from the drive.

Syntax	Returns	Example
ParReadIntFromDevice (group, index)	Parameter value casted to integer or 0 if failed. If an error is detected, the error message appears in the log.	//Read value of the parameter in group 7 index 11 each second. main() { new val; do { val = ParReadIntFromDevice(7, 11); printf "Value of (%d,%d):%d\n", 7, 11, val; Wait(1000); } while (1); }

Wait

Command delays the macro execution for given time in milliseconds.

Syntax	Returns	Example
Wait (milliseconds)	0 in all cases	//wait 0.1 seconds Wait(100)

EndMacro

Command ends the macro execution.

Syntax	Returns	Example
EndMacro()	0 in all cases	//End execution EndMacro()

GotoMacro

Command changes the macro execution. Currently running macro execution is terminated.

Syntax	Returns	Example
GotoMacro(string)	0 in all cases	//Change execution to macro jeejee new macrofilename[100] macrofilename = "jeejee.p" GotoMacro(macrofilename)

MessageBox

Command shows message box with ok button.

Syntax	Returns	Example
MessageBox (string)	0 in all cases	//show messagebox new message[100] message = "dingalongdangdong" MessageBox (message)

12

Control diagrams (pro)

Contents this chapter

This chapter describes the use of control diagrams that help in understanding the behavior of a drive.

See topics:

<i>Control diagrams overview</i>	137
<i>Viewing control diagrams</i>	138

Control diagrams overview

Control diagrams provide a graphical presentation of, for example, the control chain of a drive, the speed and torque control chains and the logic of Start and Stop functions. With these diagrams it is possible to see parameter values related to certain functions. Diagrams also illustrate the position of switches according to parameter values, which helps to understand how the drive logic works. The values of parameters can be changed via control diagrams. A control diagram consists of two levels. The top level shows an overview of the diagrams and connections between them.

Note:

- Control Diagrams are drive-specific and they are not available for all drive types.
 - When you connect a drive for the first time, it takes sometime to upload control diagrams from the drive. If Control Diagrams are not found in the drive, Drive Composer asks to upload diagrams from the local source (PC).
-

Viewing control diagrams

1. In the drive list, click on a connected drive and select **Diagrams**.

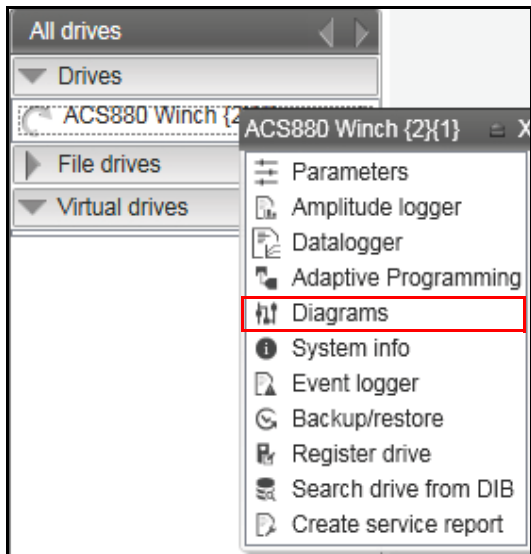

Figure 108. Control diagrams: Selecting from the drive tree

2. The top level of a control diagram consists of several diagrams and appears in a separate tab. To open a specific diagram, click on a top level control diagram box.

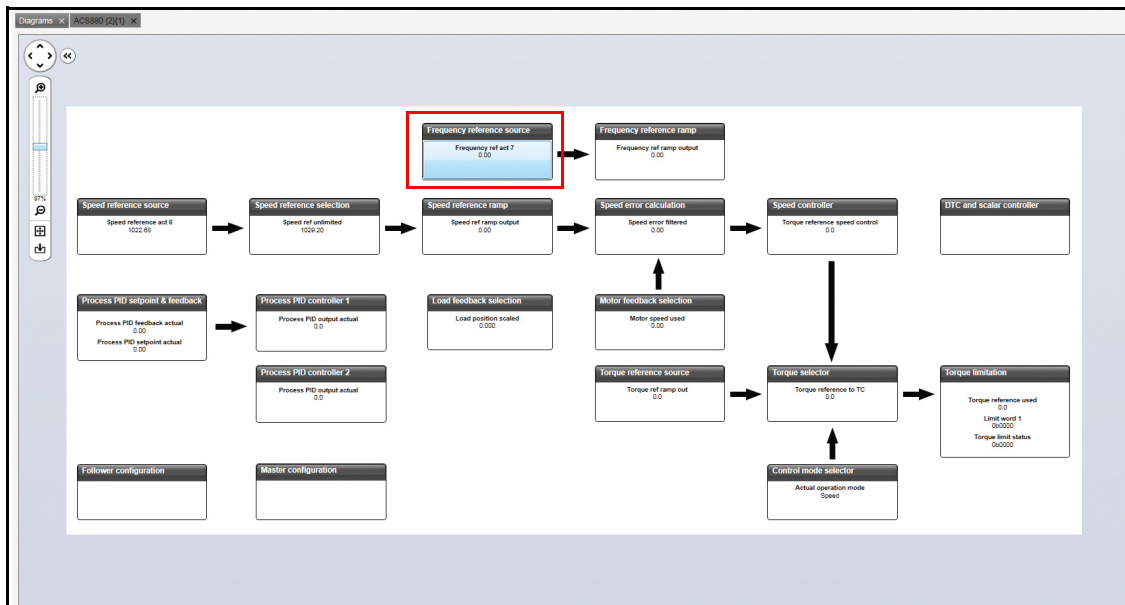

Figure 109. Control diagrams: Top level

The lower level control diagram appears in a separate tab. See the example diagram below.

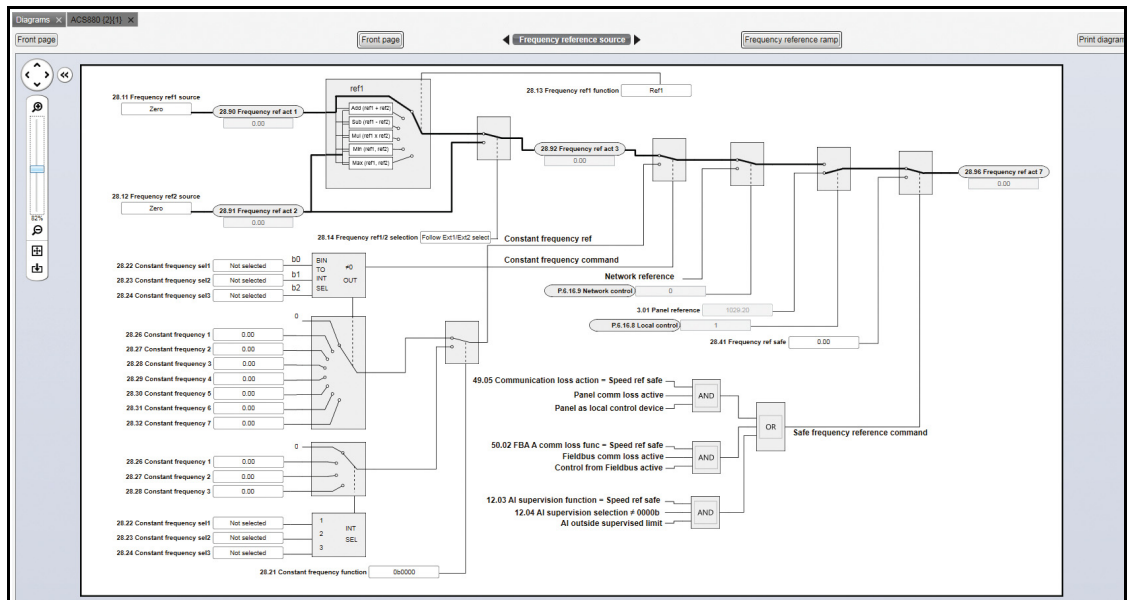

Figure 110. Control diagrams: Lower level

To navigate back to the top level of a Control Diagram, click the **Diagrams top** icon. To navigate through the reference chain, click the buttons circled in the figure above.

To zoom the control diagrams, use the zooming tool in the top left-hand corner of a Control Diagram.

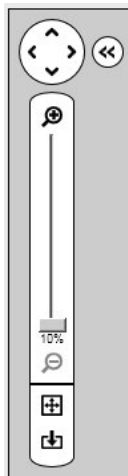

Figure 111. Control diagrams: Zooming tool



12

FSO configuration (pro)

Contents of this chapter

This chapter contains the configuration procedure of FSO-12 and FSO-21 safety functions with Drive Composer pro and provides an example of how to configure these optional FSO safety functions modules.

See topics:

<i>Configuring FSO-12 and FSO-21</i>	137
<i>Hardware connection</i>	138
<i>Setting the safety functions with Drive Composer pro</i>	138
<i>Printing the safety functions configuration report (Online)</i>	146
<i>Printing the safety functions configuration report (Offline)</i>	150
<i>Updating FSO firmware</i>	151
<i>Changing FSO module password</i>	155
<i>Reading FSO module parameters</i>	157

Configuring FSO-12 and FSO-21

The safety configuration of FSO-12 and FSO-21 safety functions module is available only in Drive Composer pro, DCPT-01 (code: 3AUA0000108087).

Note:

- Only trained persons are allowed to configure the safety functions.
 - Stop the drive before configuring the safety functions modules. You cannot download/upload the configuration file to/from safety functions module or change the password when the drive is modulating.
 - You need a password to copy the configuration to the safety functions and also to validate the safety parameter settings.
 - You can open a *dcsafety* file in Demo mode of Drive Composer pro.
-

For detailed information about FSO-12 and FSO-21, see the respective safety functions module user’s manual:

- *FSO-12 safety functions module user’s manual* (3AXD50000015612 [English]).
- *FSO-21 safety functions module user’s manual* (3AXD50000015614 [English]).

■ Hardware connection

The hardware connection is common for both FSO-12 and FSO-21 safety functions module. For instructions on the hardware connections, see *FSO-12 safety functions module user’s manual* (3AXD50000015612 [English])/ *FSO-21 safety functions module user’s manual* (3AXD50000015614 [English]).

The following configuration description assumes that all hardware-related connections are made properly and the ID run procedure of the drive is completed.

■ Setting the safety functions with Drive Composer pro



WARNING! The motor must be stopped. Safety configuration file can be edited (and sanity checked) in demo mode for offline configuration. Edit and save the file to PC without connecting to the drive/FSO.

1. Power up the drive. Make sure that the motor is not running.
See [Working area](#) on page 153.
2. Right-click on drive and select **Safety settings**.

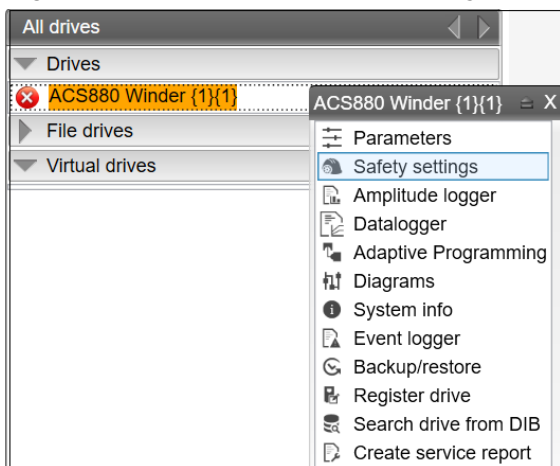

Figure 112. FSO configuration: Selecting safety settings with FSO module

In online mode with FSO installed, the safety configuration already available in the drive is displayed (see figure below). In offline mode the view is always empty before opening the safety file.

You can switch between **Graphical view** and **Parameter view**. See [Figure 113.FSO configuration: Graphical view](#) and [Figure 114.FSO configuration: Parameter view](#).

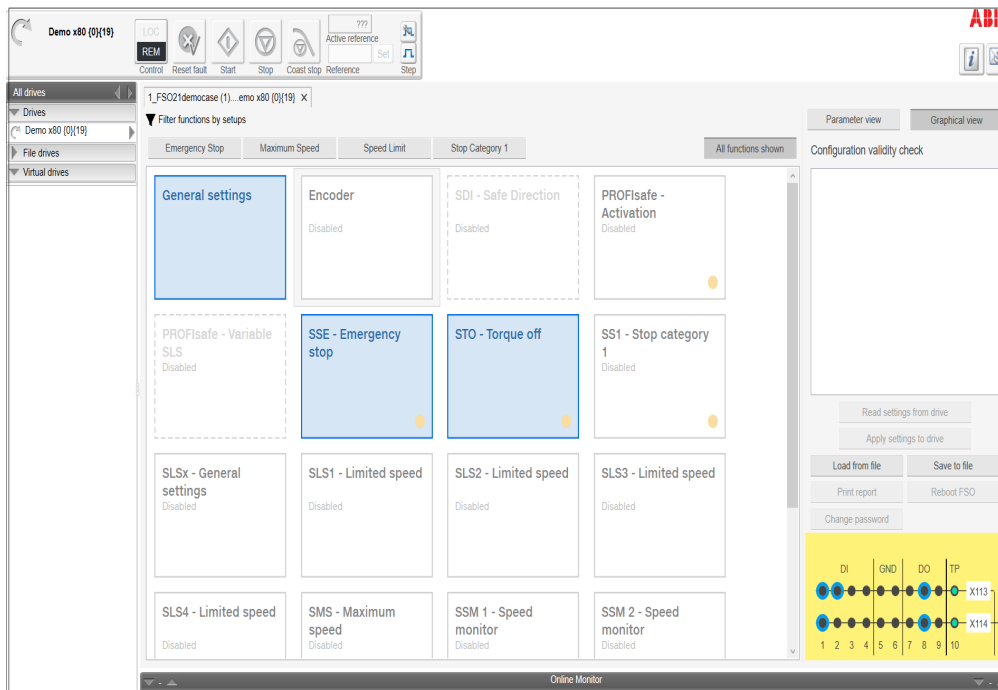

Figure 113. FSO configuration: Graphical view

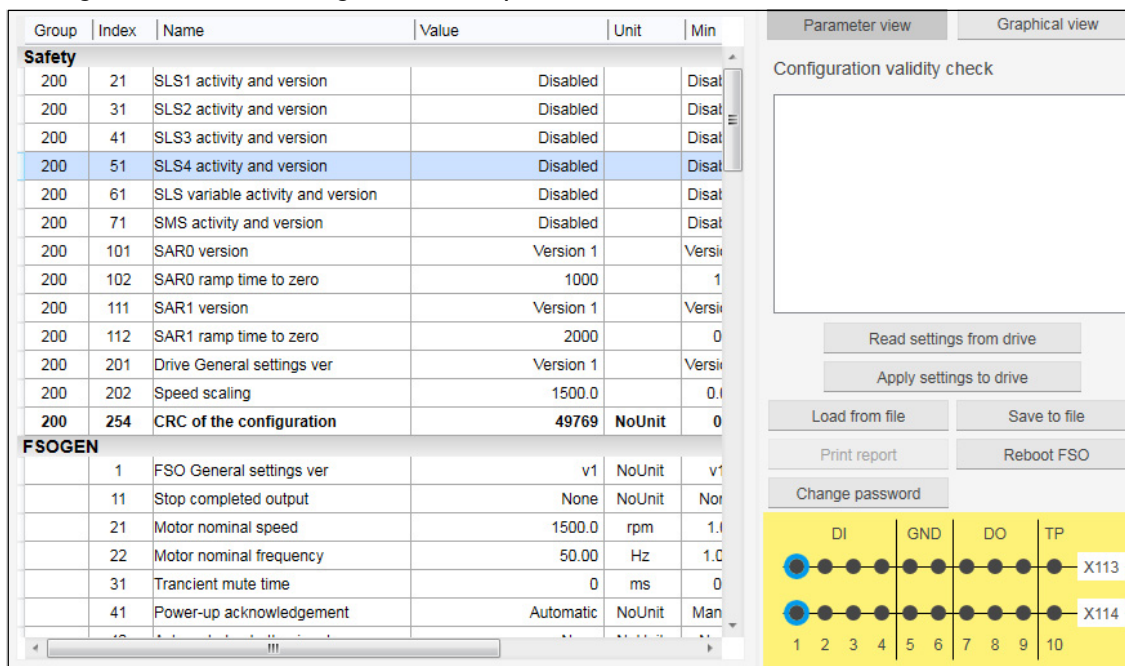

Figure 114. FSO configuration: Parameter view

3. Click **Read settings from drive**.

Note: When you upload the safety settings from FSO module to PC tool, the FSO goes into Configuration state and indicates a fault. You can exit the Configuration state by rebooting the FSO module if you do not want to download the settings but want to keep the existing setting.

The Fault **FSO general fault: 7A8B** appears on the drive.

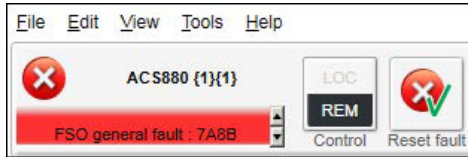

Figure 115. FSO configuration: FSO general fault due to configuration state

4. Type the password (8 numbers). The factory default password is “12345678”.

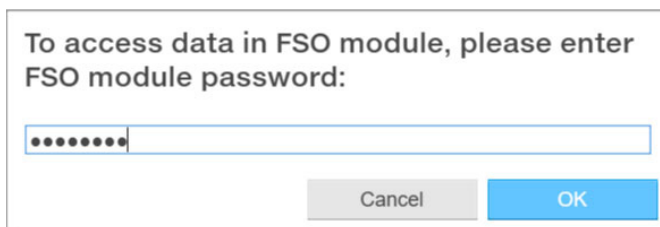

Figure 116. FSO configuration: Enter password

Note: You can change password by clicking **Change password** (see figure [FSO configuration: Parameter view](#)). Make sure the drive is not modulating. The password must contain 4...8 digits. Do not forget the new password; otherwise you have to do a factory reset to the FSO which clears the configuration and resets the parameters to the factory defaults.

5. Configure the safety parameters. Set the following safety function parameters:
- **General parameters:** Check that the motor parameters are correct.
 - **I/O:** Check that I/O parameters are set according to the installation (wiring) plan. Remove diagnostic pulsing from any unused I/O. The test pulses are off by default. Check possible safety relays and cascade connections.
 - **Safety functions:** Check all safety settings. You must at least check and set the STO and SSE related settings, regardless of whichever FSO safety functions you use. The FSO activates the STO and SSE functions (also in internal fault situations). The FSO uses the STO and SSE functions for making the system safe. All other functions are used only for monitoring the drive.

Notes:

- Graphical view cannot be used for setting safe IO, cascade function or for SBC function (see [Figure 113.FSO configuration: Graphical view](#)). Instead use the Parameter view (see [Figure 114.FSO configuration: Parameter view](#)).
- Parameter groups (200, 91 and 92) that include common parameters to drive and FSO are referred with group numbers and index numbers.
- Group names like **F SOGEN**, **STO** and so on have only index numbers (see [Figure 124.FSO configuration: Edit parameters](#)).

For detailed information about FSO-12 and FSO-21 configuration settings, see the respective safety functions module user’s manual:

- *FSO-12 safety functions module user’s manual* (3AXD50000015612 [English]).
- *FSO-21 safety functions module user’s manual* (3AXD50000015614) [English].

- If required, click **Filter functions by setups** and filter the safety functions tile. You can click any of the filtering options to view safety functions related to the selected selection.

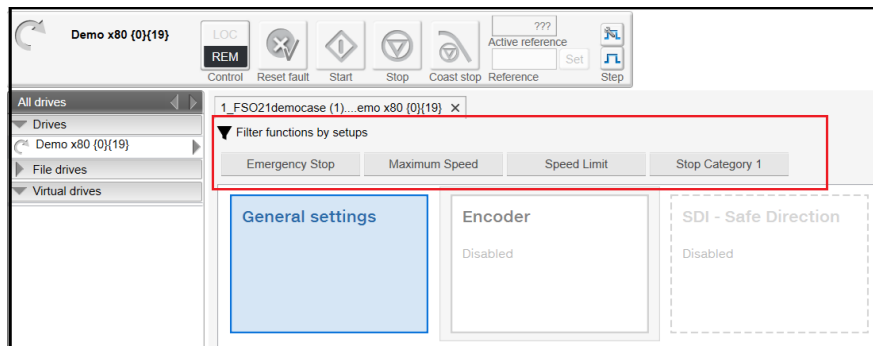

Figure 117. FSO configuration: Filter function in graphical view

- In the Graphical view, double-click to open the function. Use the slider switch to enable or disable a function.

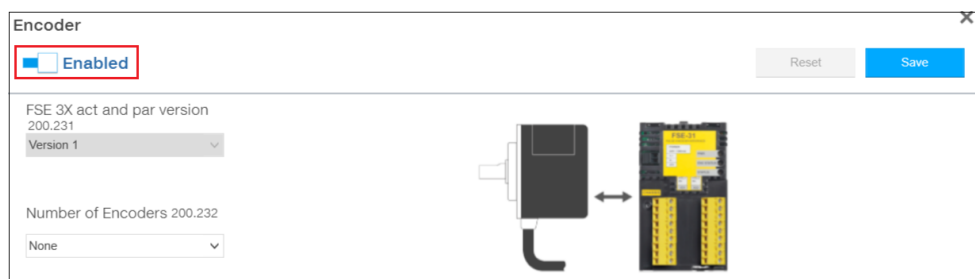

Figure 118. FSO configuration: Enable/Disable security function

Notes:

- By default, **General settings**, **SSE-Emergency stop**, and **STO- Torque off** groups are enabled and cannot be disabled.
- Some functions are dependent on their main functions. Enable the main function to activate its dependent functions. For example:
 - SDI-Safe direction** can be enabled only if you enable the main Encoder function.
 - Profisafe-Variable SLS** can be enabled only if you enable the main **Profi-Safe Activation**
 - SLSx General Settings is automatically activated if you enable any of these main functions: SLS1...SLS4 or the ProfiSafe-Varialbe SLS.

See also the representations of enabled and disabled functions in below figure. Note that a dependent disabled function appears in a dotted box.

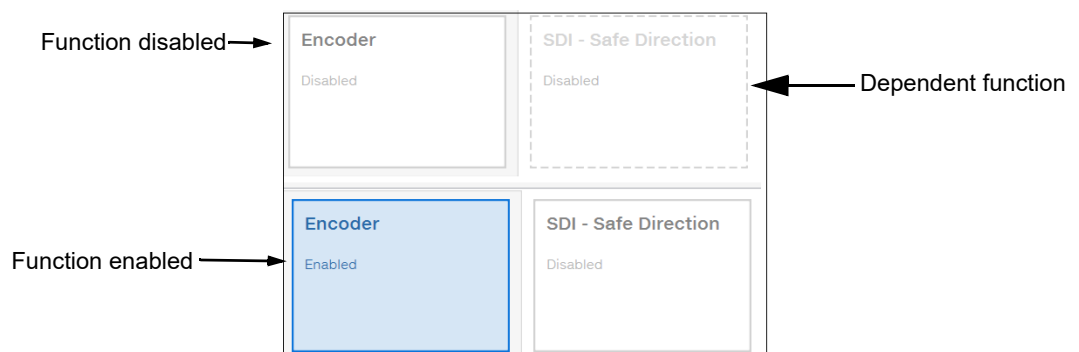

Figure 119. FSO configuration: Dependent function

- After you make changes and if you try to disable a function, a warning message dialog box appears. Click **Yes** to save the changes and disable the function. This helps to make the changes available during the edit. To discard the changes, click **No**.

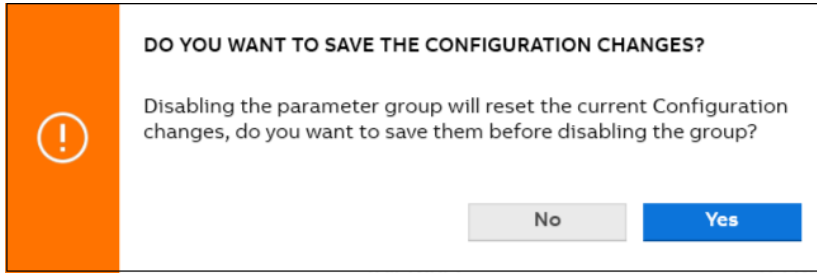

Figure 120. FSO configuration: Save configuration changes and disable

8. In the opened tile view, configure the function and edit the necessary parameters.

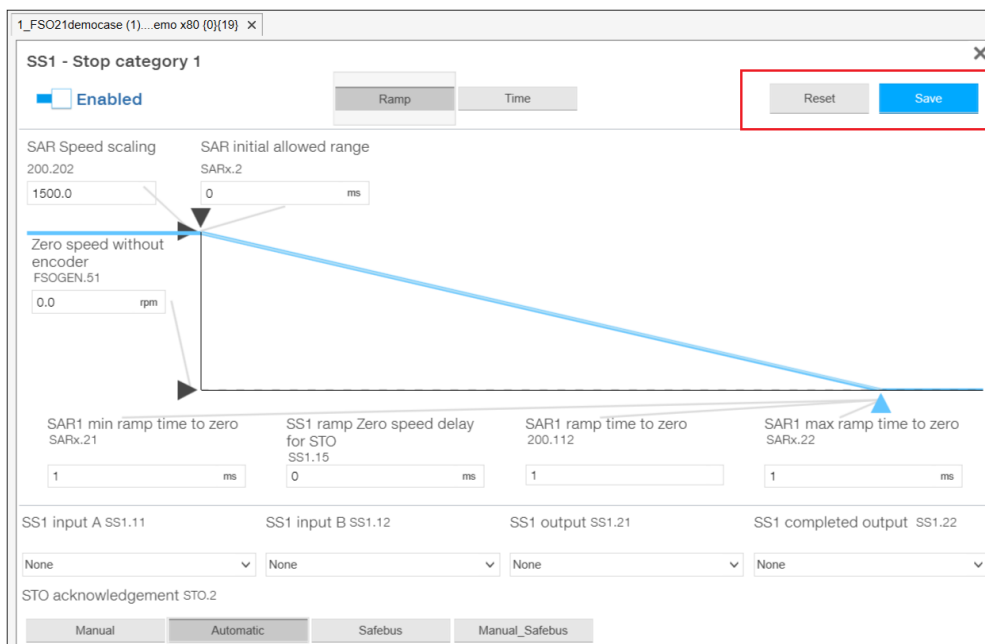

Figure 121. FSO configuration: Configure function or general settings group

- Click **Save** to save the changes. Click **Reset** if you want to disable the function and reset the values to default values. A yellow circle appears in the function, if you change the default values in the function.

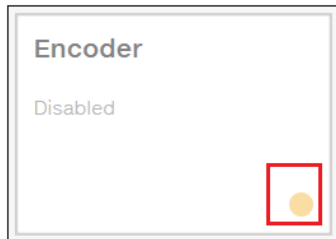

Figure 122. FSO configuration: Non default values in the function

If you close the window before you save the changes, a warning message dialog box appears. Click **Yes** to save the changes. To cancel the changes, click **No**.

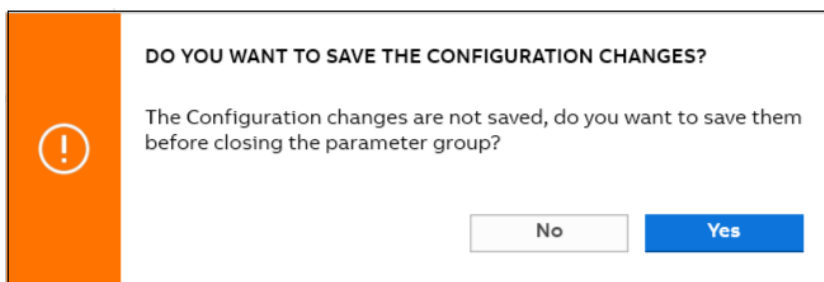

Figure 123. Configure change confirmation

Note: In graphical view the SAR settings are combined with safety function parameters. Using the reset option for parameters that are used crosswise (e.g. SAR1 is used with SS1 and SLS functions) resets the particular settings for both functions. The function works the same in parameter view in which the parameters are in separate groups.

- In Parameter view, double-click on the value field and change all necessary configuration settings to match the safety configuration.

Group	Index	Name	Value	Unit	Min
	12	STO input B	None	NoUnit	Nor
	13	Restart delay after STO	3600000	ms	0
	14	Time to zero speed with STO and mc	3600000	ms	0
	21	STO output	None	NoUnit	Nor
	22	STO completed output	None	NoUnit	Nor
SBC					
	1	SBC version	Version 1	NoUnit	Versi
	11	STO SBC usage	None	NoUnit	Nor
	12	STO SBC delay	3600	ms	-50
	13	SBC time to zero speed	3600000	ms	0
	15	SSE/SS1 SBC speed	0.0	rpm	0.1
	21	SBC output	None	NoUnit	Nor
	22	SBC feedback action	STO	NoUnit	ST
POUS					
	1	POUS activity and version	Disabled	NoUnit	Disat
SSE					
	1	SSE version	Version 1	NoUnit	Versi
	11	SSE input A	None	NoUnit	Nor
	12	SSE input B	None	NoUnit	Nor
	13	SSE function	Immediate STO	NoUnit	Imme
	14	SSE monitoring method	Ramp	NoUnit	Rar
	15	SSE delay for STO	20000	ms	0

Figure 124. FSO configuration: Edit parameters

- Test your safety configuration when the motor is running.

- Right-click on drive and select **Parameters** to check the values in parameter group 200.

You can also validate the safety function parameters using the signal monitoring feature. See the instructions for [Adding parameters/signals for monitoring](#). It is possible to check the ramp times and the status of bit changes in the time domain.

Index	Name	Value	Unit	Min	Max	Default
93. Encoder 2 configuration						
94. LSU control						
95. HW configuration						
96. System						
97. Motor control						
98. User motor parameters						
99. Motor data						
200. Safety						
1	FSO speed ch1	0.00	rpm	-34028...	3402823060737100000...	0.00
2	FSO speed ch2	0.00	rpm	-34028...	3402823060737100000...	0.00
3	FSO DI status	0b0000	NoUnit	0b0000	0b1111 1111 1111 1111	0b0000
4	FSO DO status	0b0000	NoUnit	0b0000	0b1111 1111 1111 1111	0b0000
5	FSO control word 1	0b0001	NoUnit	0b0000	0b1111 1111 1111 1111	0b0000
6	FSO control word 2	0b0100	NoUnit	0b0000	0b1111 1111 1111 1111	0b0000
7	FSO status word 1	0b0110 1100	NoUnit	0b0000	0b1111 1111 1111 1111	0b0000
8	FSO status word 2	0b0000	NoUnit	0b0000	0b1111 1111 1111 1111	0b0000
9	Drive status word 1	0b0110	NoUnit	0b0000	0b1111 1111 1111 1111	0b0000
10	Drive status word 2	0b0111 0000 0000	NoUnit	0b0000	0b1111 1111 1111 1111	0b0000
11	FSO module type	FSO-12	NoUnit			No option
12	FSO hardware version	0x0010 0000	NoUnit	0x0000	0xffff ffff	0x0000
13	FSO firmware version	0x0232 0000	NoUnit	0x0000	0xffff ffff	0x0000
231	FSE 3X act and par version	Disabled	NoUnit			Disabled
232	Number of Encoders	None	NoUnit			None
254	CRC of the configuration	49769	NoUnit	0	65535	0

Figure 125. FSO configuration: Parameter group 200

- Check the values in online mode while testing the safety functions. If there are unexpected values, right-click the parameter and select **Refresh the parameter**.
- After testing save the FSO configuration to PC. In Parameter view, click **Save to file**.

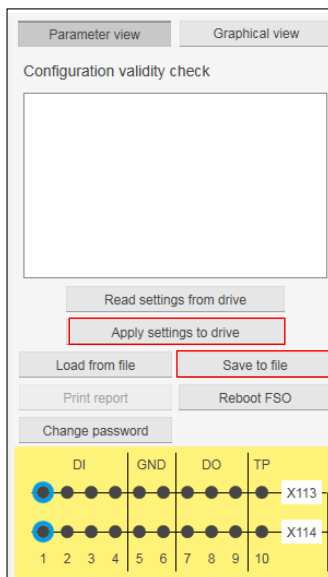

Figure 126. FSO configuration: Saving the safety settings

The file is saved as *dcsafety* format and the File written successfully dialog appears. Click **Ok**.

15. Click **Apply settings to drive**.
16. Enter the password to apply the settings to the drive and click **Ok**.
The following Validate dialog appears. Click **Yes**.

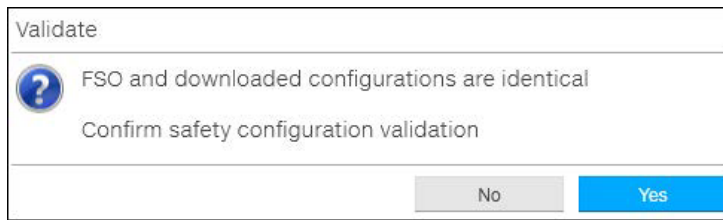

Figure 127. FSO configuration: Validate dialog

Note: If you do not want to download the changes in safety parameters, you can boot FSO without downloading to FSO using Reboot FSO (see figure [FSO configuration: Saving the safety settings](#)).

17. Click **Ok** to close the dialogs.

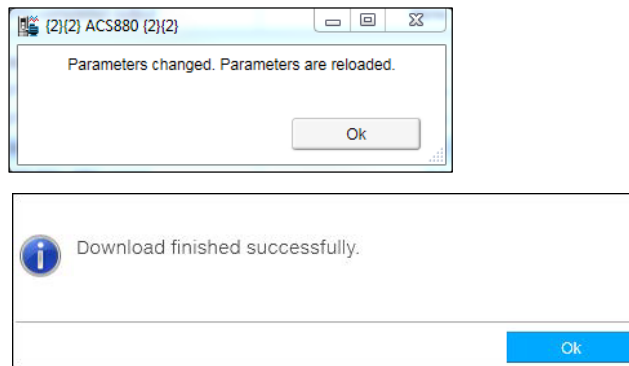

Figure 128. FSO configuration: Safety configuration ok message

■ **Printing the safety functions configuration report (Online)**

With the FSO module installed, you can print the online safety functions configuration report.

1. From the **Safety settings** view, click **Print report**.

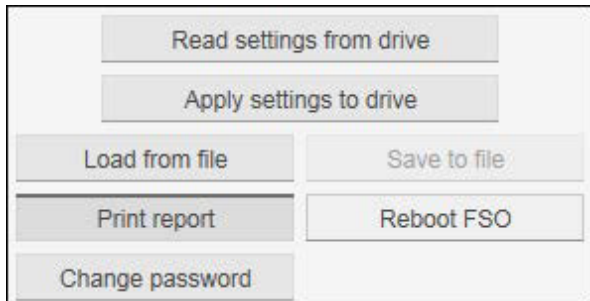

Figure 129. Safety configuration report: Print Report

2. Select a print template and click **Continue**.

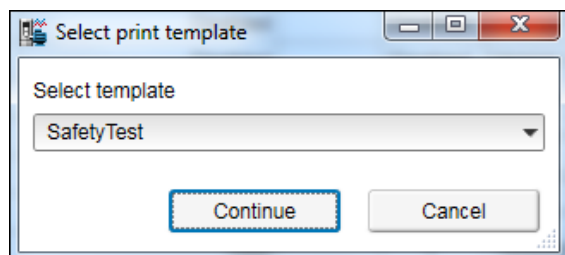

Figure 130. Safety configuration report: Select print template

3. Fill in the Drive and FSO version information. Click **Next**.

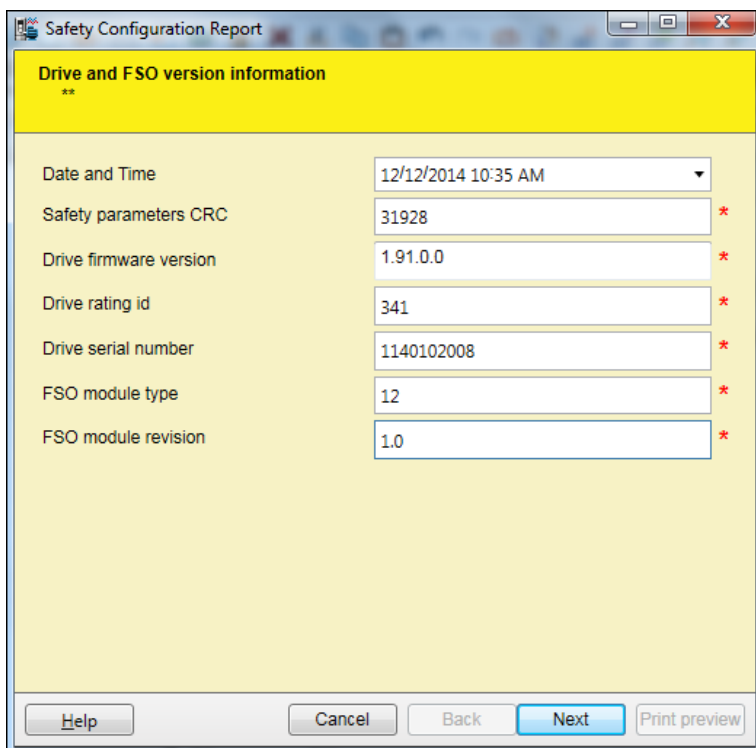

Figure 131. Safety configuration report: Drive and FSO information

The next screen(s) contain different aspects of safety configuration such as configured safety functions, commissioning checklist, and so on.

The List of configured safety functions and acknowledged methods appears. Click **Next**.

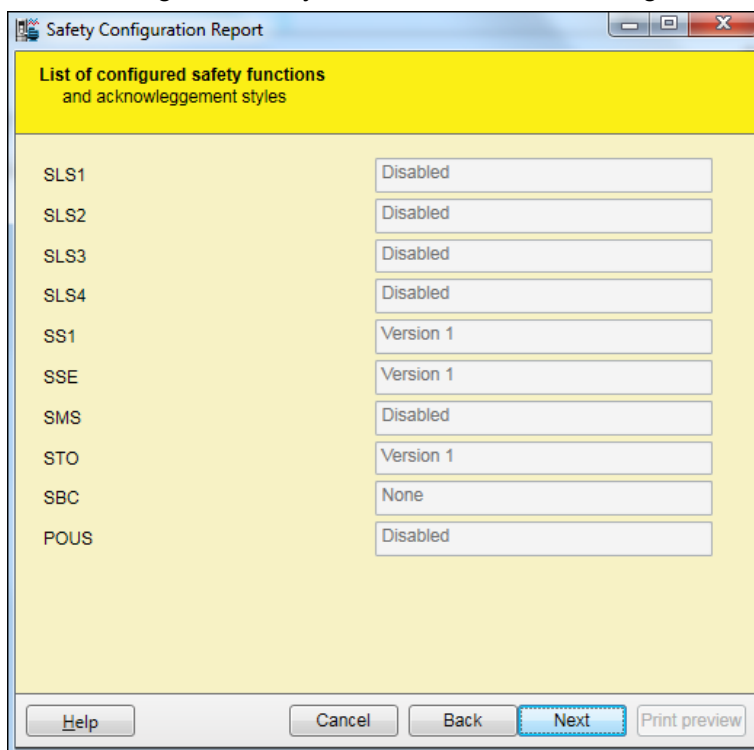

Figure 132. Safety configuration report: List of configured safety functions

In the FSO commissioning checklist, click on the check boxes to mark configurations are ok. Click **Next**.

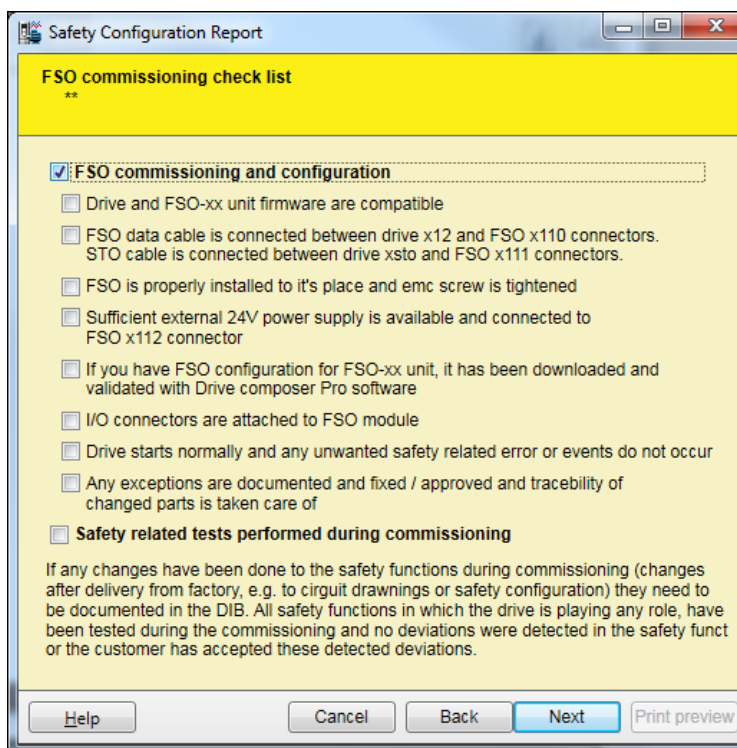

Figure 133. Safety configuration report: FSO commissioning check list

In the FSO changes/repair details, type the required details and click **Next**.

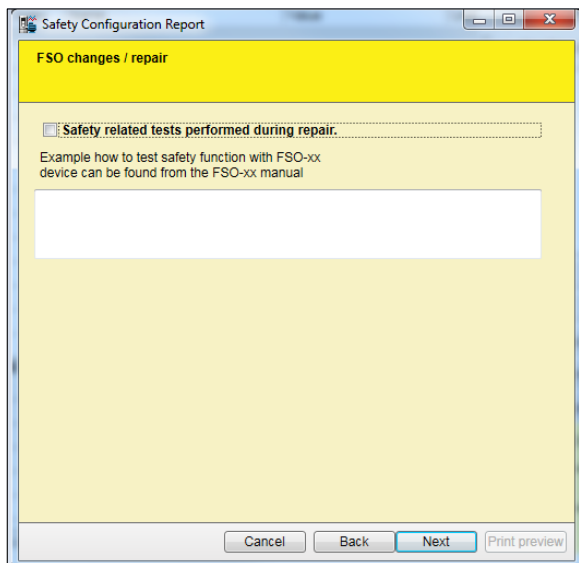

Figure 134. Safety configuration report: FSO changes/repair

4. In the final screen fill in the required details and click **Print preview**.

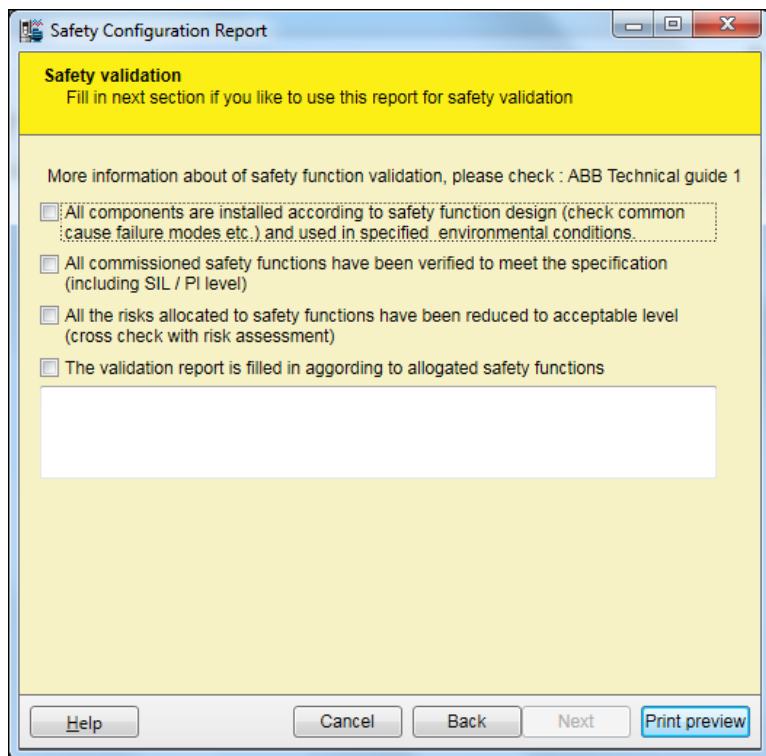

Figure 135. Safety configuration report: Print preview

5. Select the required printer settings and click **Print**.

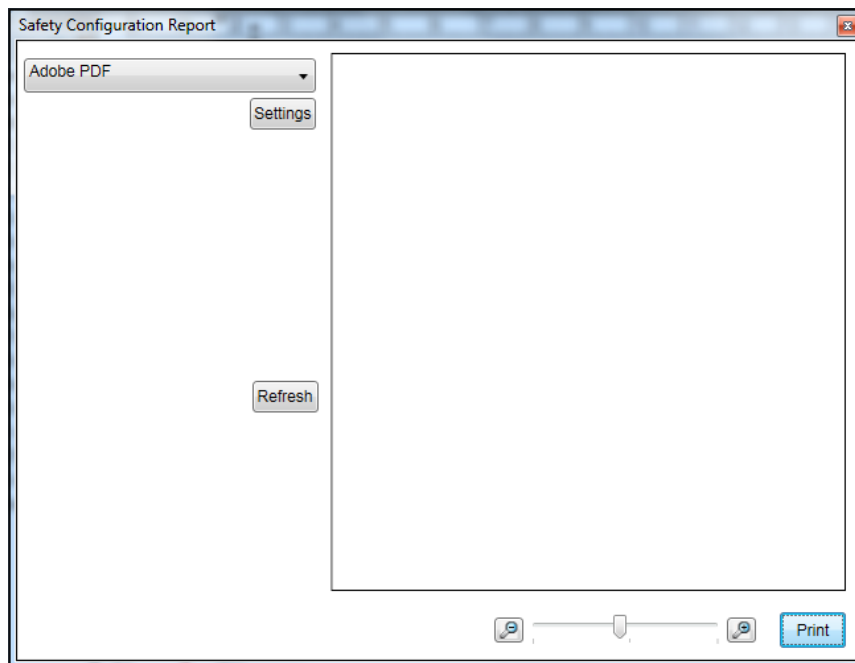

Figure 136. Safety configuration report: Printer settings

The configuration and commissioning report is printed based on the selected printer settings.

■ Printing the safety functions configuration report (Offline)

To print a FSO safety functions configuration report in the Offline mode, you must have a saved safety file. See section [Setting the safety functions with Drive Composer pro](#) (page 138).

1. Click **Tools** → **Safety Configuration Report**.

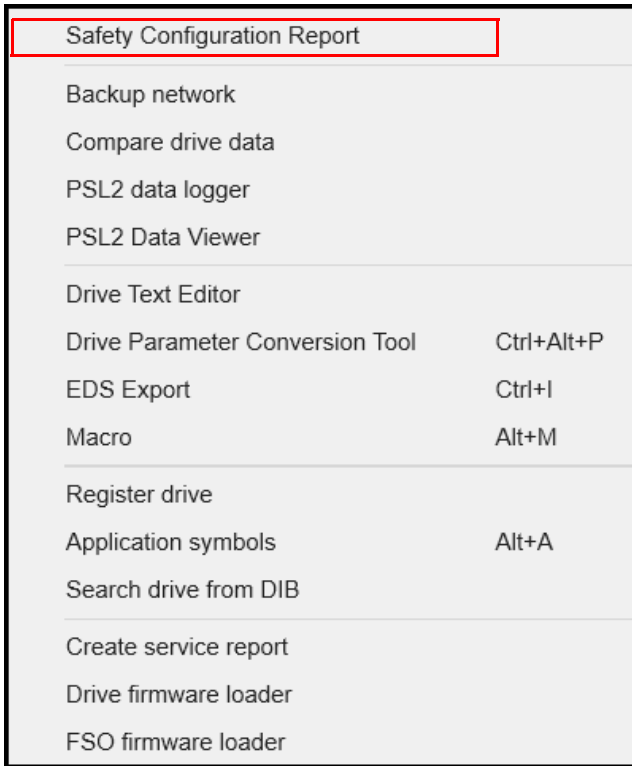

Figure 137. Print safety configuration report: Tools menu

2. Select the saved file to print and click **Continue**.

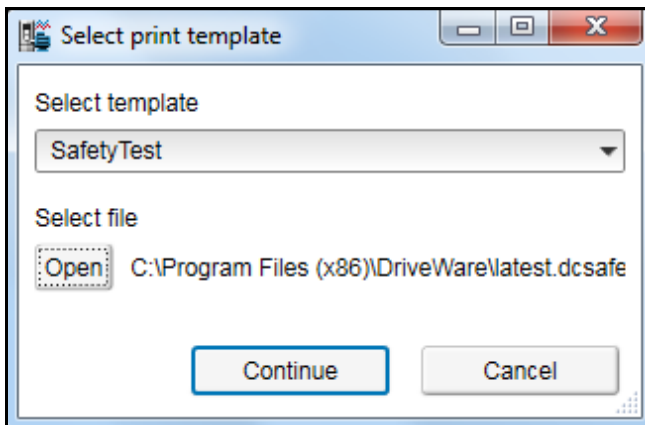

Figure 138. Print safety configuration report: Select print template

Continue from step 3 in section [Printing the safety functions configuration report \(Online\)](#), page 146.

Updating FSO firmware

To know the FSO firmware version and to update the FSO firmware, you will need access to the FSO module.

1. Click **Tools** → **FSO firmware loader**.

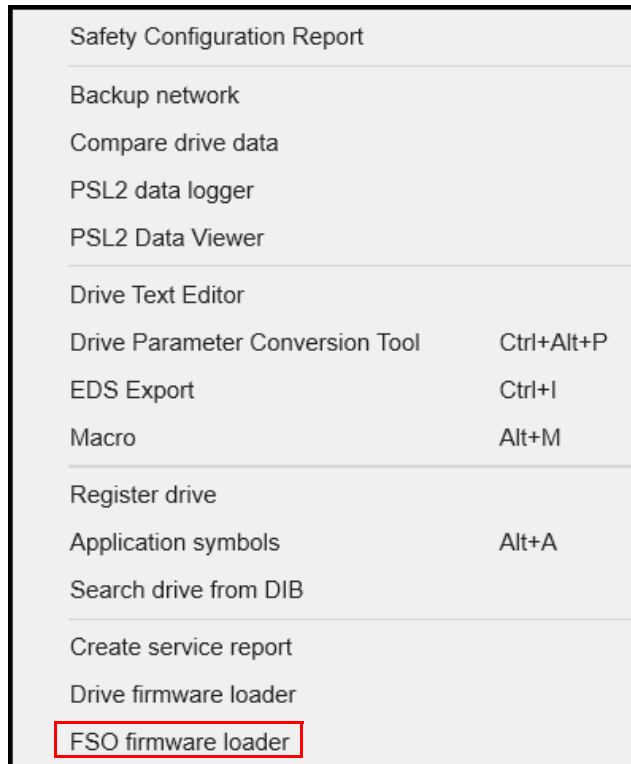

Figure 139. Tools → FSO firmware loader

2. Select the required drive. Click **OK**.

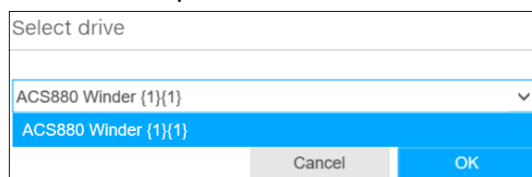

Figure 140. Select drive

3. If you changed the FSO module default password, the Log in window appears. Enter the new password and click **Log in**.

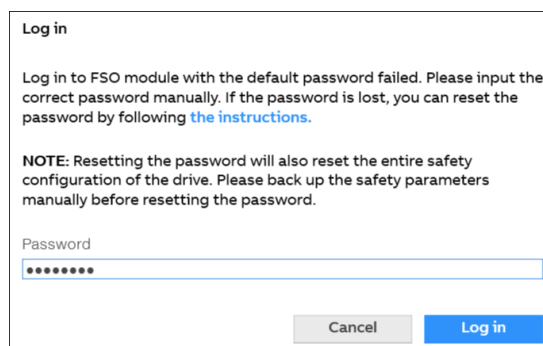

Figure 141. FSO login with changed password

- Wait while Drive Composer checks for FSO firmware version.

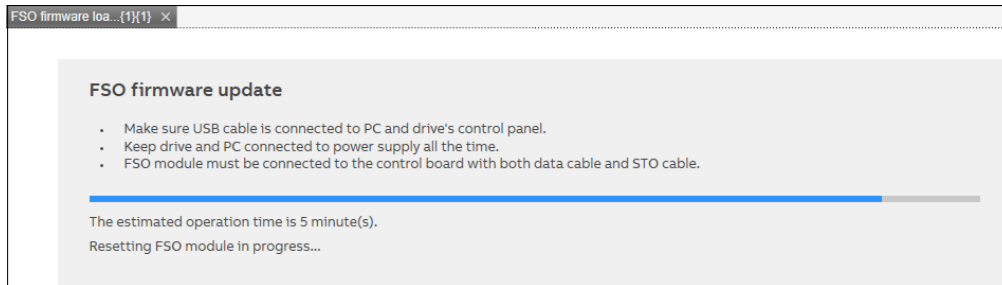

Figure 142. Checking FSO firmware version

- The FSO firmware loader shows the current version and the update version (if available). Click **Next** to continue with updating the FSO firmware.

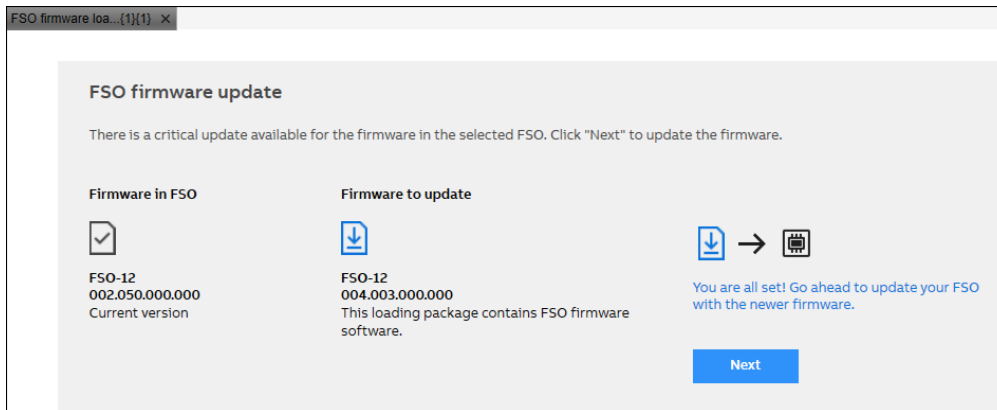

Figure 143. Updating FSO firmware

- Accept the terms and conditions to continue. Click **Confirm**.

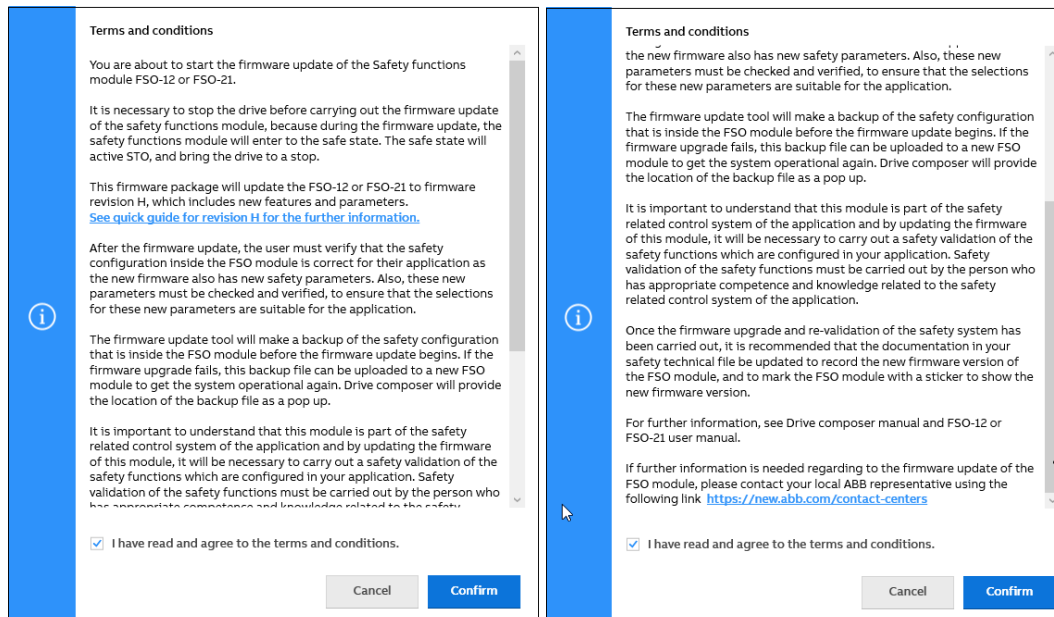

Figure 144. FSO firmware update terms and conditions

7. Follow FSO firmware update instructions. Click **Start**.

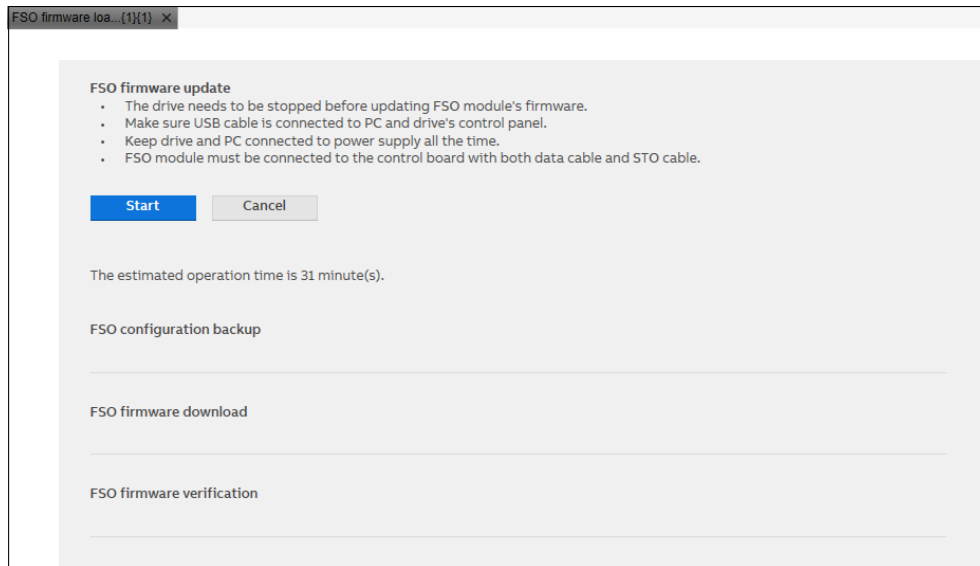

Figure 145. Start FSO firmware update

8. Wait while the FSO firmware update is in progress.

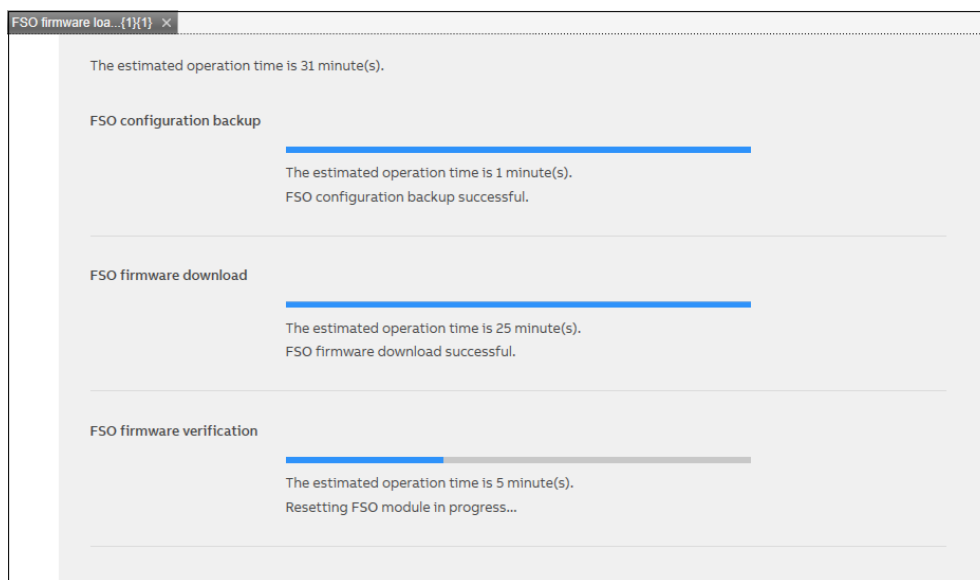

Figure 146. FSO firmware update in progress

9. After the FSO configuration backup, firmware download, and firmware verification is completed, the firmware update for the selected FSO is successful. Click **Next**.

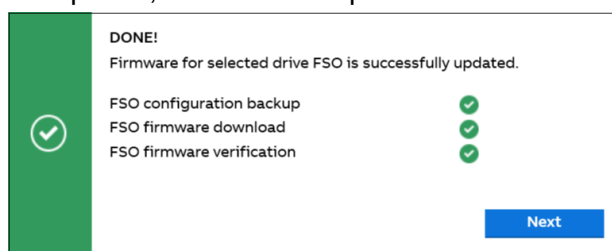

Figure 147. FSO firmware is successful

10. Accept the Disclaimer conditions to continue. Click **Confirm**.

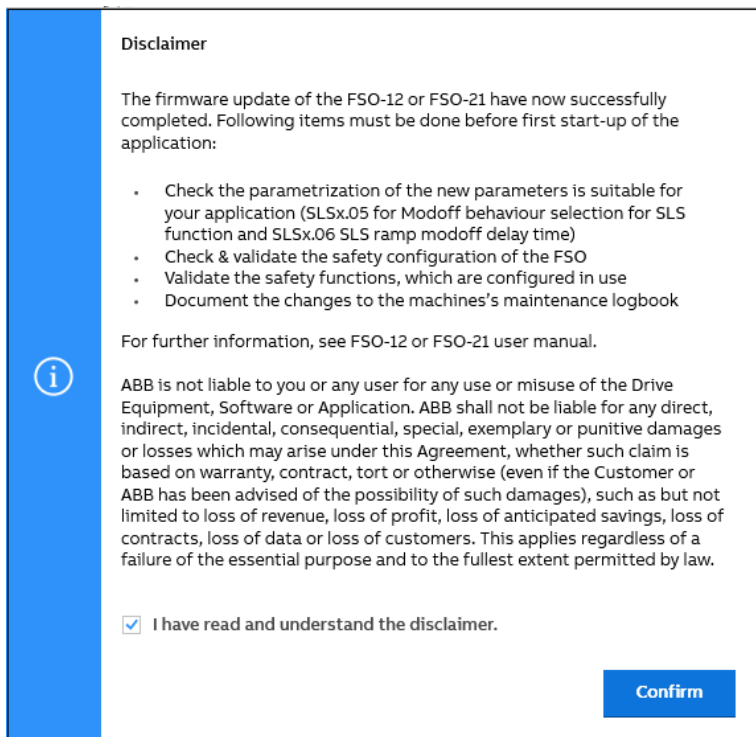

Figure 148. FSO firmware update: Disclaimer conditions

11. FSO firmware loader displays the updated firmware version as current version. Click **x**, to close the loader window.

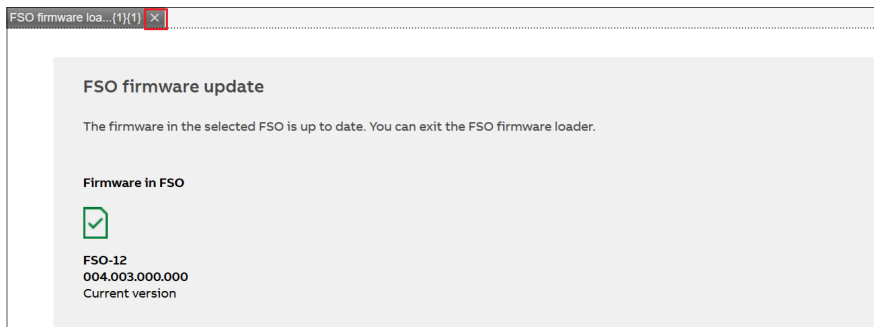

Figure 149. FSO firmware updated

Changing FSO module password

1. Right-click on drive and select **Safety settings**.

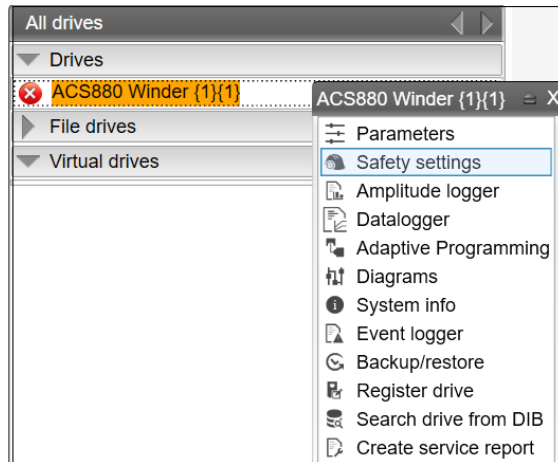

Figure 150. Safety settings

2. In the Safety settings window, click **Change password**.

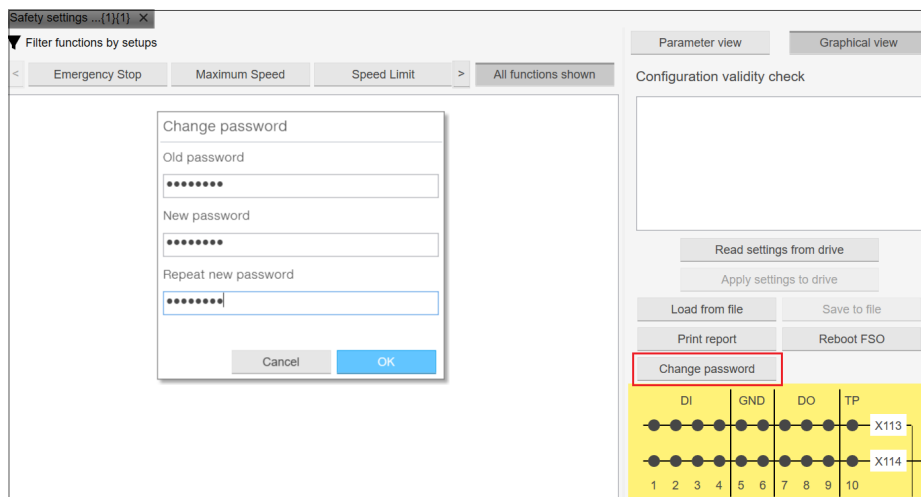

Figure 151. Safety settings: Change password

3. In the Change password dialog, type the old or default password and type the new password. Click **OK**.

Note: The password should contain 4...8 numbers. For more information, see FSO module manual.

4. Wait while the password change is in progress and the parameters are reloaded.
Click **OK**.

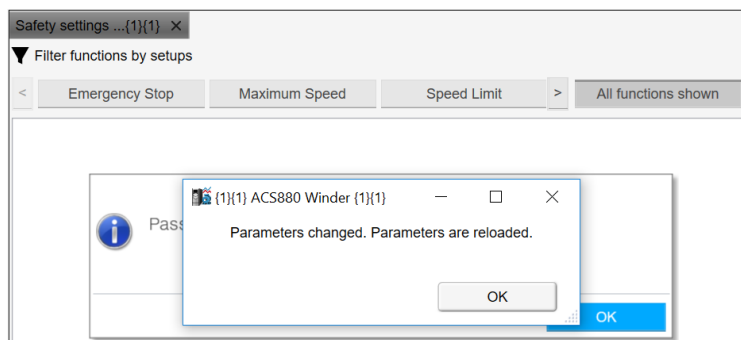

Figure 152. FSO password change in progress

5. Click **OK**, to confirm the password change. You can test the new password, for example, to log in to FSO module (see section, [Updating FSO firmware](#)) or to read FSO drive parameters (see section, [Reading FSO module parameters](#)).

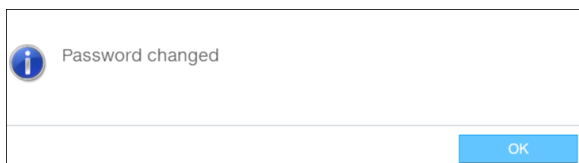

Figure 153. FSO password changed

Reading FSO module parameters

To read the FSO module drive parameters:

1. In the Safety settings window, click **Read settings from drive**.

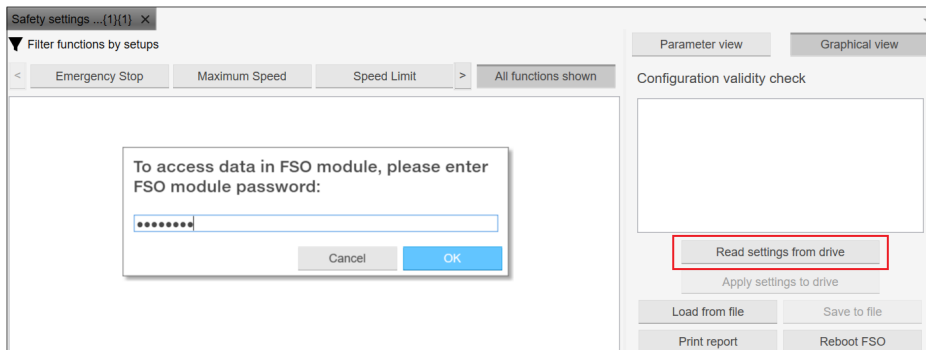

Figure 154. Safety settings: Read settings from drive

2. Type the FSO module password. Click **OK**.
3. Wait while Drive Composer is updating the safety parameters file and displays the safety settings dashboard. Click **Parameter view** to switch to parameter window and vice versa.

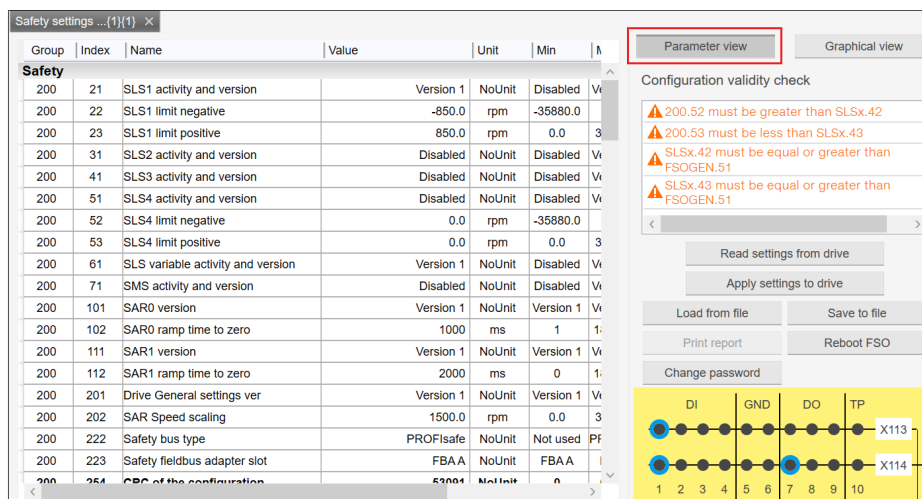
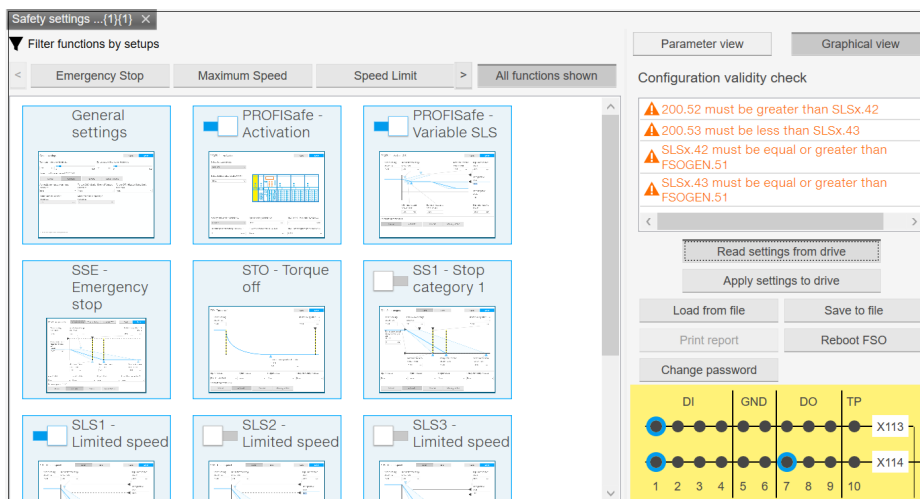

Figure 155. Safety settings: Graphical and parameters view

13

Drive configuration

Contents of this chapter

This chapter contains the configuration procedure of the drive.

See topics:

<i>Loading firmware (pro)</i>	160
<i>Drive backup</i>	165
<i>Creating a backup of a drive</i>	165
<i>Creating a backup in drive parameter view</i>	166
<i>Creating a quick parameter backup (pro)</i>	167
<i>Restoring a drive</i>	168
<i>Restoring a drive backup</i>	168
<i>Restoring a backup in the drive parameter view</i>	169
<i>Restoring a set of components/parameters settings (pro)</i>	170

Loading firmware (pro)

To load the drive firmware, make sure the drive is connected to Drive Composer via USB cable. For more information, see section [Connecting to drive with Assistant control panel](#) on page 138.

1. Power up the drive. Make sure that the motor is not running. See section [Using the working area](#) on page 153. If drive is connected via USB cable, Drive Composer automatically discovers the drive.



Figure 155. Drive Composer: Start window

2. Click **Tools** → **Drive firmware loader**.

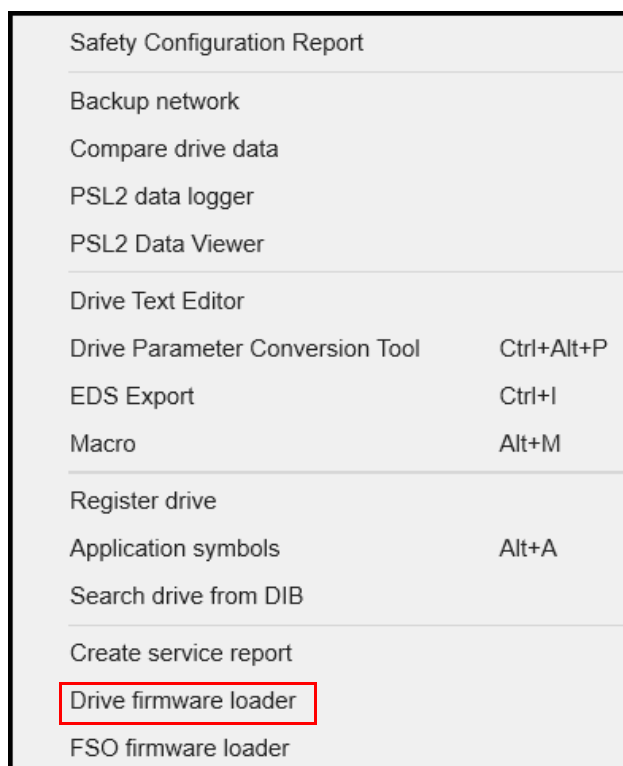

Figure 156. Tools menu

- If multiple drives are connected, from the selection list, select the drive to load the firmware and click **OK**.

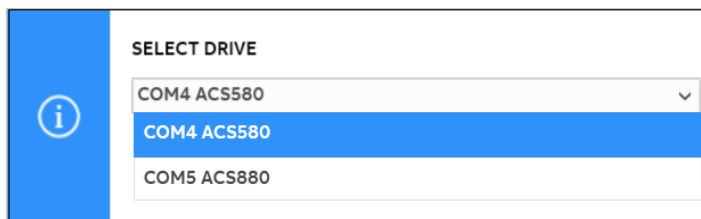

Figure 157. Select drive

- Click **Browse** and select the loading package file.

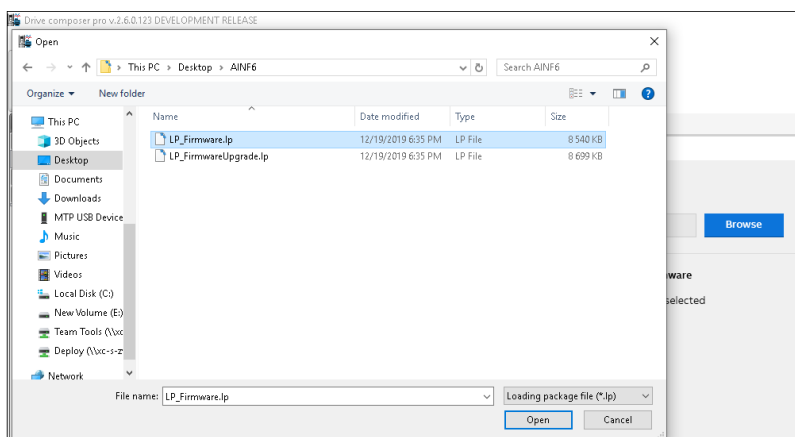

Figure 158. Select LP file

- If applicable, select the software set.

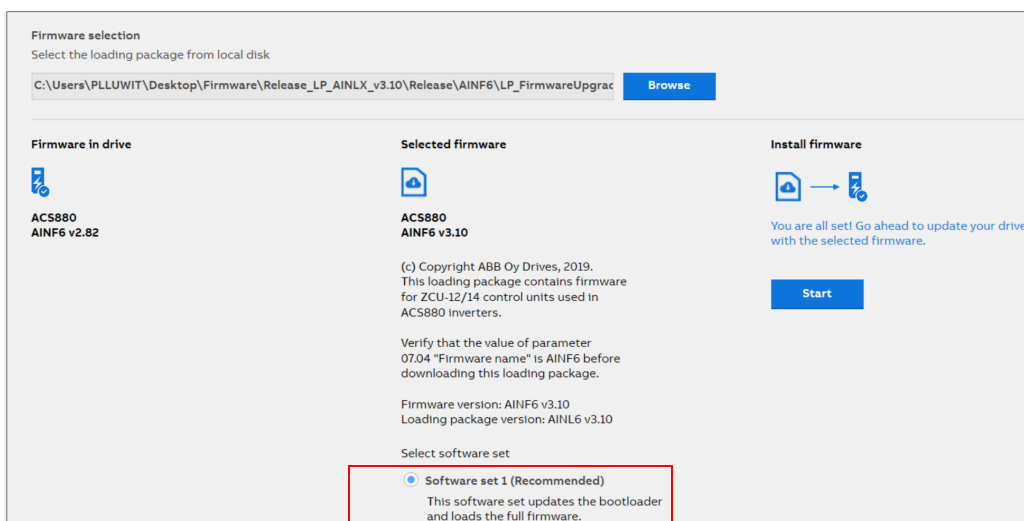

Figure 159. Select software set

- If applicable, select the acceptance statement check box. This appears when you try to downgrade the firmware, load incompatible firmware or if you are using customized firmware.

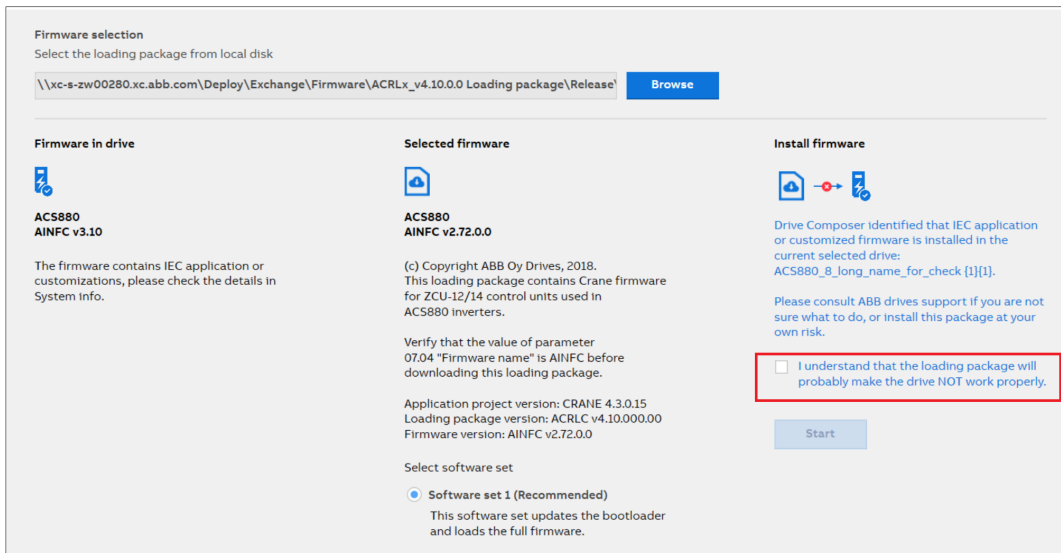

Figure 160. Risk acceptance check box

Note: If you try to load a corrupted or invalid loading package file, the application displays an error message.

- Click **Start**.
- If you want to create a parameter backup of the existing firmware, select the Create parameter files check box and select the location to save the file.

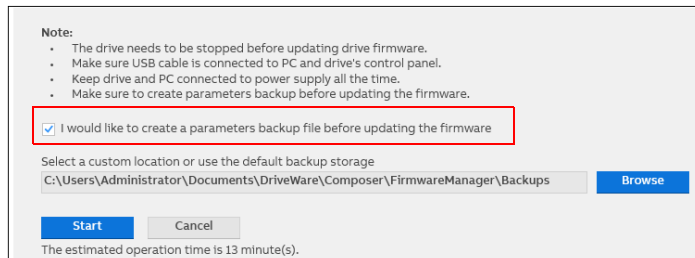

Figure 161. Parameter backup

9. In the drives that do not support parameter restore in remote control mode, a warning dialog box appears if the drive is in remote control mode. Click **OK** and change the drive control mode to **Local**.

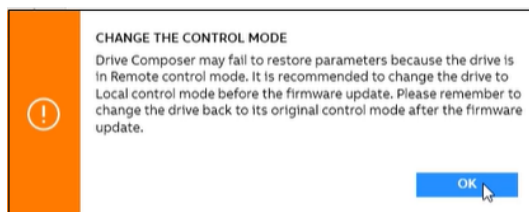

Figure 162. Parameter restore warning

If you proceed the operation with remote control mode, the following error message appears.

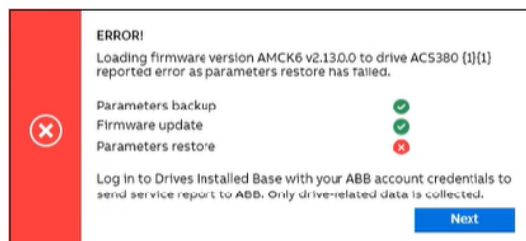

Figure 163. Parameter restore error

10. Click **Start**.
11. Wait for the firmware to be loaded. The backup time can be more if you opt for the parameter backup option.

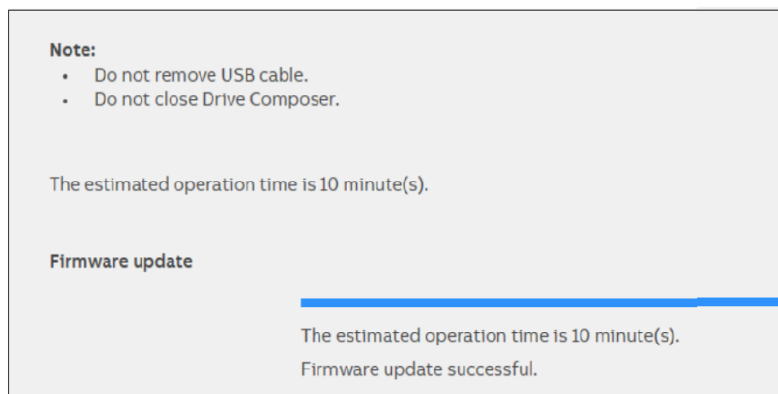

Figure 164. Firmware installation

12. In the **Parameters changed. Parameters are reloaded** message appears, click **OK**.

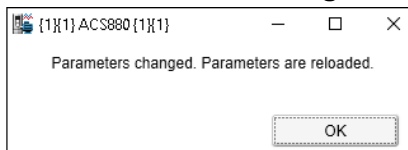

Figure 165. Parameters changed confirmation

13. In the **DONE!** dialog box, Click **Next**.

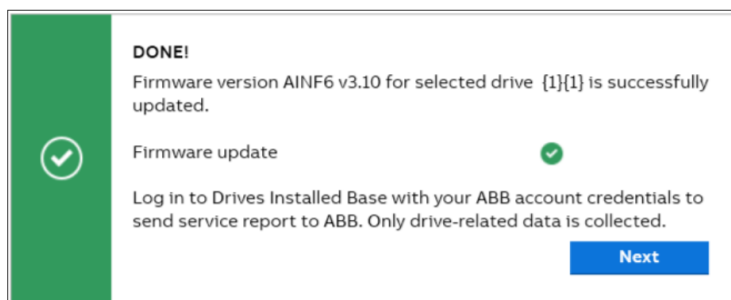

Figure 166. Firmware update complete

14. Enter the service report information. For more information, see section [Create online service report](#) on page 183.

Note: You need access to Drive installed base to send the service report.

15. Click **Send**.

The installation successful page appears.

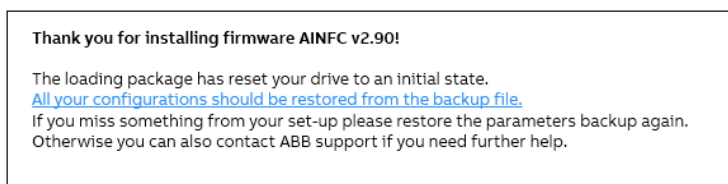

Figure 167. Drive firmware installed confirmation

Drive backup

■ Creating a backup of a drive

1. Click on a connected drive and select **Backup/restore**.

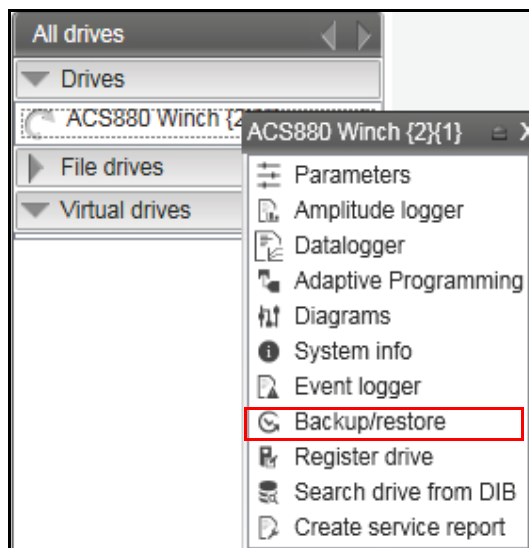

Figure 168. Backup command

2. Select the file location for the backup and give a name for the backup file.

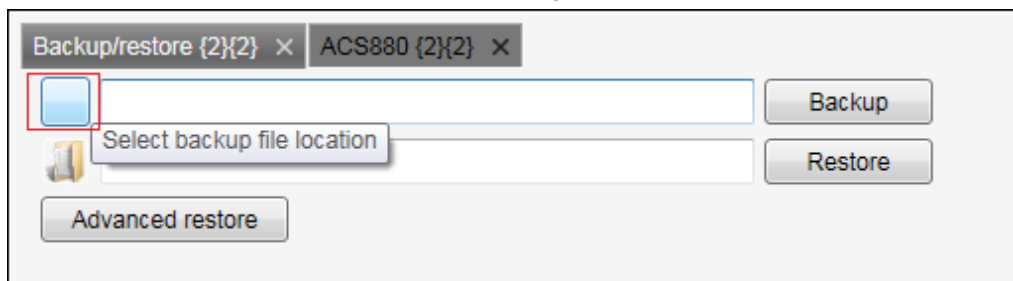

Figure 169. Backup/restore: select backup file location

3. Click **Backup** to start the backup process.

The backup process takes a few minutes.

You can also create a backup in the drive parameter view. See [Creating a backup in drive parameter view](#).

■ Creating a backup in drive parameter view

1. In the parameters view, click on **Save parameters to file** icon.

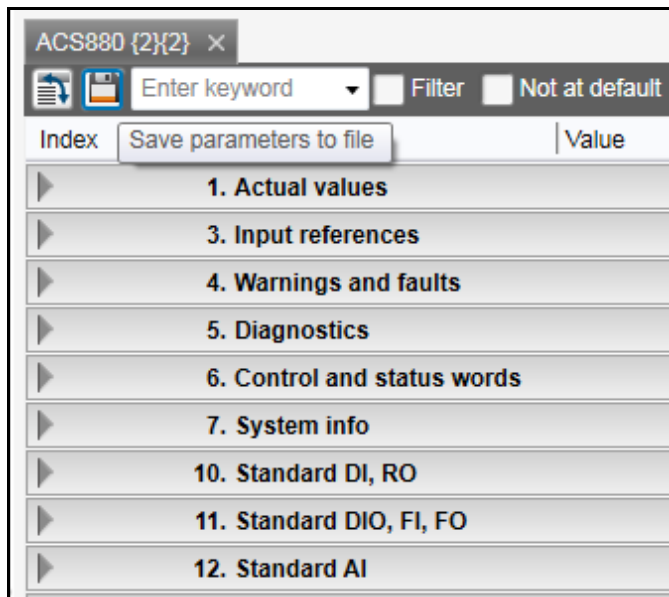

Figure 170. Create backup in drive parameter view

2. Select a file location in your computer for the backup and give backup file name. Click **Save**.
The backup process takes a few minutes.

■ Creating a quick parameter backup (pro)

The quick parameter backup feature helps to create a faster parameter backup, when the network speed is slow and effects the communication speed between Drive Composer and the drive. In quick parameter backup, the Drive Composer stores only the parameter groups that are viewed, expanded or edited. This helps to save the parameter backup time and avoids parameter backup failure.

When the drive parameter backup is slow, the function automatically detects the connection speed between the Drive Composer and the drive, and provides you an option of quick parameter backup. You can select between a full parameter backup or a quick parameter backup.

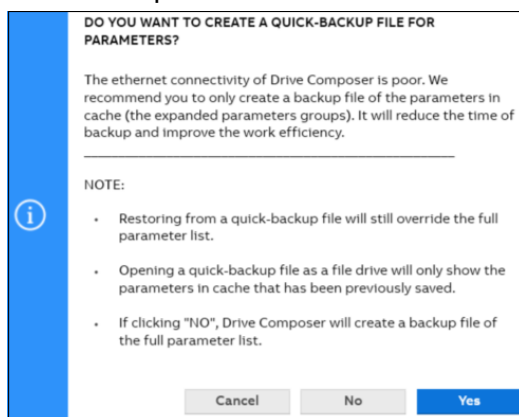

Figure 171. Quick drive parameter backup

Notes:

- This function is applicable when the drive is connected to the Drive Composer via Ethernet cable.
- The restore function work as usual, i.e. the function restores the complete parameter list.

Restoring a drive

Restoring a drive backup

1. Click on a connected drive and select **Backup/restore**.

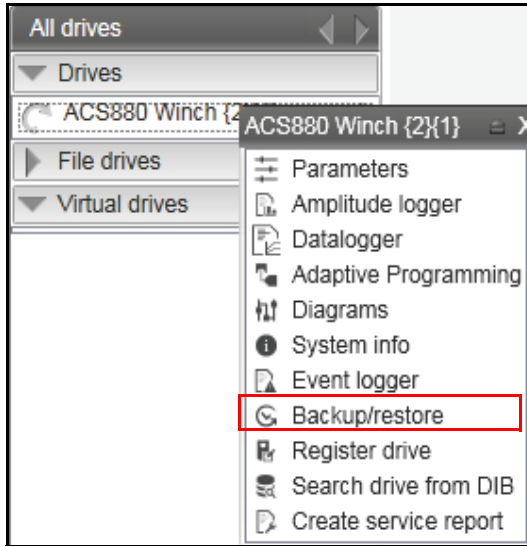

Figure 172. Restore command

Note: In the drives that does not support parameter restore in remote control mode, a **CHANGE THE CONTROL MODE** warning appears to change the control mode to local control mode.

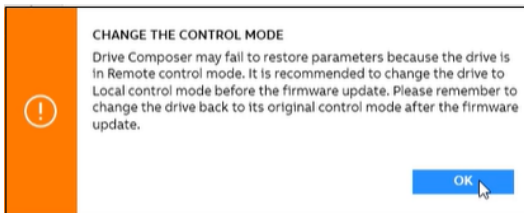

Figure 173. Parameter restore change control mode warning

If you proceed the operation with remote control mode, the following error message appears.

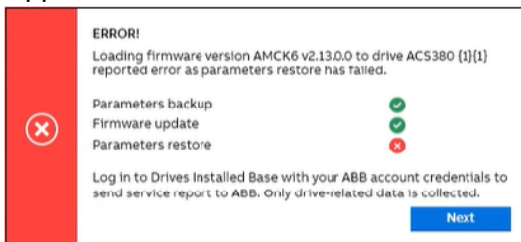

Figure 174. Parameter restore error

2. Select the backup file to restore to the drive.

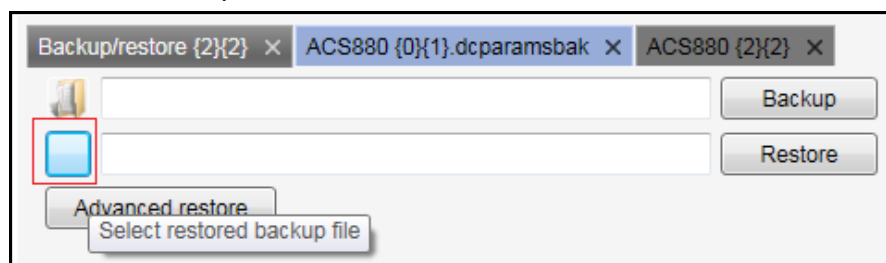
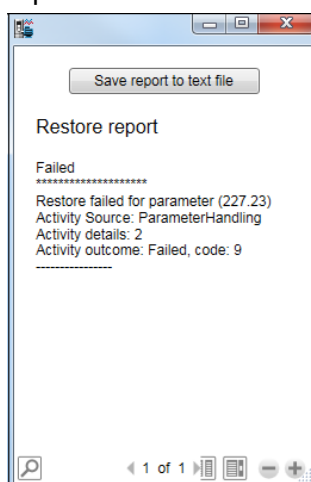

Figure 175. Backup/restore: select restored backup file location

3. Click **Restore**.

All available components are restored from the backup file and all unavailable components are preserved in the drive. A detailed status appears in the Restore report.



4. You can also save the report as text file. In the Restore report window, click **Save report to text file**. and save the file in your PC.
5. Save the file in your PC. Click **Cancel** to close the report.

Restoring a backup in the drive parameter view

1. Open a parameter backup file. Click **Download to device** icon.

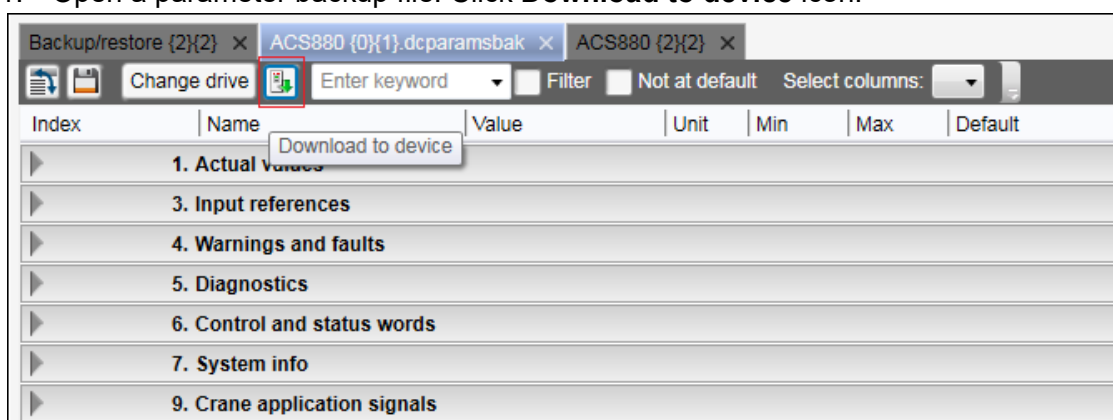

Figure 176. Backup/restore: Restore in drive parameter view

All available components are restored from the backup file and all unavailable components are preserved in the drive.

■ Restoring a set of components/parameters settings (pro)

With the **Advanced restore** function you can restore separate items or group of items in the backup file.

1. Click on a connected drive and select **Backup/restore**.

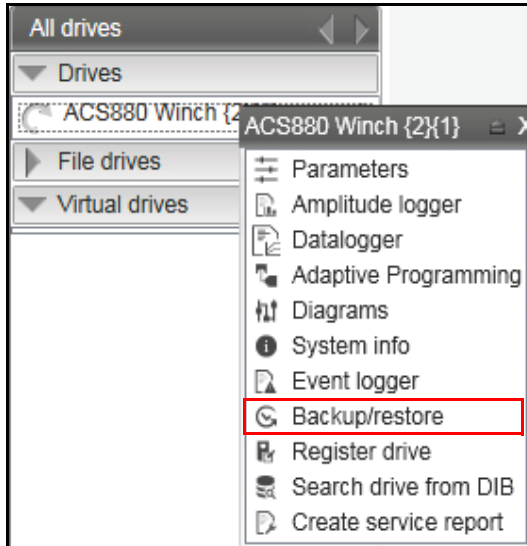

2. Click **Advanced restore** to select a restored backup file.

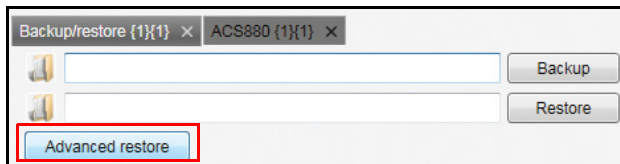

3. Select a saved backup file and click **Open**.
4. In **All items**, you can select single item(s) or a total group to restore. Click right arrow (>>) to move the selected items to **Selected items**.

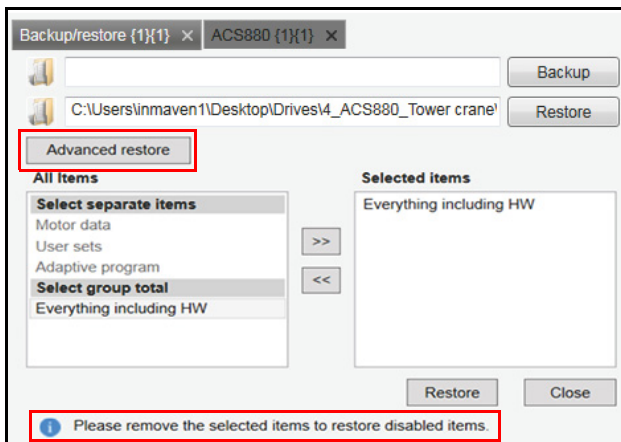

Note: The message *“Please remove the selected items to restore disabled items.”* appears inside the restore window only when you selected

- single item(s) and all other items are disabled
- a group item and all single items are disabled.

5. Click **Restore**.

The selected items are restored from the backup file and a restored successfully message appears. Non-selected items are preserved in the drive.

Note:

- The parameter values that are not written to the drive are listed in the restore report after the restore process.

The drive does not allow to restore the grey items in the advanced list.



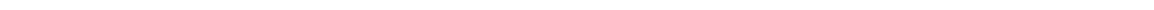



14

Other functions

Contents of this chapter

This chapter describes common functions that are not associated with any view or window.

See topics:

<i>Using Drive Installed Base service</i>	174
<i>Recovery and prevention of FB14 fault in drive</i>	190
<i>Using the Drive text editor</i>	196
<i>Using the Drive parameter conversion tool (pro)</i>	199
<i>Using the PSL2 data logger (pro)</i>	202
<i>Using the PSL2 data viewer (pro)</i>	204
<i>Adaptive programming</i>	206
<i>Locking user interface</i>	207
<i>RADIUS authentication</i>	211

Using Drive Installed Base service

Drive Installed Base (Drive Installed Base) is a knowledge base for all information about drives. Using Drive Installed Base service you can,

- register an ABB drive through Drive Composer (see page 174)
- obtain the required drive information (see page 179)
- create service reports (see page 182).

■ Registering an ABB drive to Drive Installed Base service

1. From the drive context menu select **Register drive**, or go to **Tools** → **Register drive**.

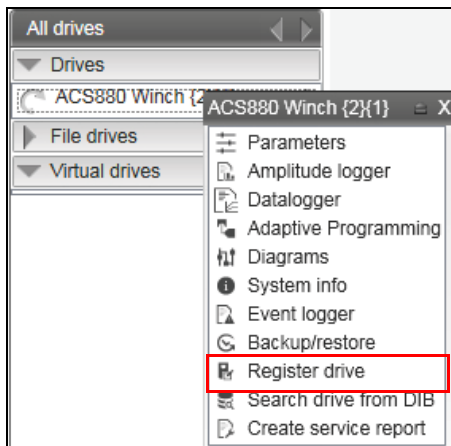

Figure 176. Register drive

If you used the drive context menu, make sure that Drive Composer is connected online with the drive for successfully registering the drive. If you used **Tools** → **Register drive**, you can register the drive when Drive Composer is either in online/offline mode with the drive.

2. In the Drive registration tab, type the drive serial number (for example, 32400110) and click **Validate**. You can see the drive serial number on the type designation label or see the drive's hardware manual for more information.

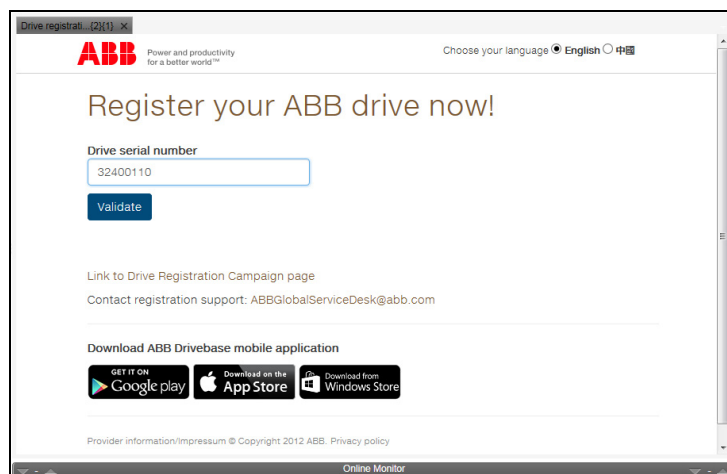
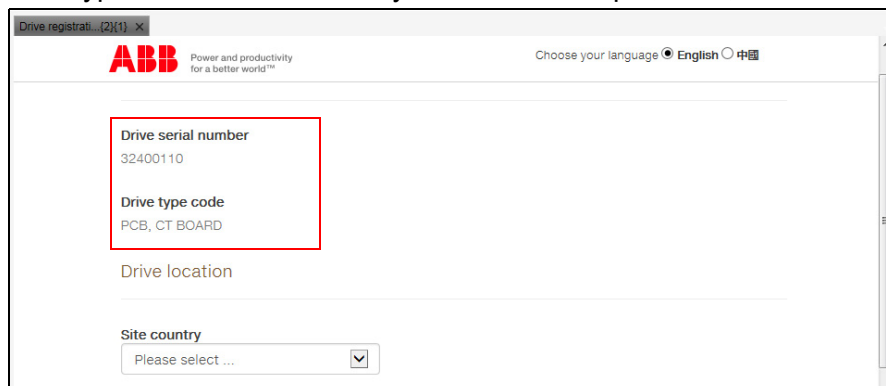

Figure 177. Register drive: Drive serial number

Drive Composer connects to Drive Installed Base portal (external website) and validates the serial number with an associated type code. If the number is valid, the drive type code is automatically filled. For example, PCB, CT BOARD.



The screenshot shows a web browser window titled "Drive registrati... (2)(1) X". The page features the ABB logo and the tagline "Power and productivity for a better world™". A language selection menu is visible, with "English" selected and "中國" as an option. The main content area contains a registration form with the following fields:

- Drive serial number:** 32400110
- Drive type code:** PCB, CT BOARD (This field is highlighted with a red box in the image)
- Drive location:** (Empty text input field)
- Site country:** A dropdown menu with the text "Please select ..." and a downward arrow icon.

Figure 178. Register drive: Drive type code

Note: You can register a serial number for first-time only. If attempted second time, the message “*This serial number has been already registered*” is displayed.

3. Enter drive location details in the appropriate fields.

The screenshot shows a web browser window titled "Drive registrati...{2}{1} x". The ABB logo is in the top left, with the tagline "Power and productivity for a better world™". In the top right, there is a language selection menu with "English" selected and "中國" as an option. The form contains the following fields:

- Drive serial number:** 32400110
- Drive type code:** PCB, CT BOARD
- Drive location:** (Section header)
- Site country:** India (dropdown menu)
- Company name:** ABB INDIA LTD DMDR
- Site name:** IDC DMDR
- Site city:** Bangalore
- Site postal code:** 560048
- Site address:** Whitefiled, Bangalore
- Plant/Building:** IDC
- Area/Room:** DMDR lab

Figure 179. Register drive: Drive location details

Field name	Information
Site country	Name of country where the drive is located, for example, India.
Company name	Name of company where the drive is located. For example, ABB India.
Site name	Site name where the drive is located.
Site city, Site postal code	Name of city and postal code where the drive is located.
Site address	Site address.
Plant/Building, Area/Room	Optional. Plant /building name and area/room where the drive is located.

4. Type name and email address of the drive owner or the contact person details. Phone number is optional.

Drive owner/ contact person

First name

Last name

Email address

Phone number

Figure 180. Register drive: Drive owner details

5. Type/select drive information in the appropriate fields.

Drive information

Customer equipment id for the Drive

Commissioning start up date

Application

Criticality in process

Industry

By registering you accept the Terms and Conditions

Provider information/Impressum © Copyright 2012 ABB. Privacy policy

Figure 181. Register drive: Drive information

Field name	Information
Customer equipment id for the Drive	Optional. Customer identification of drive, if available.
Commissioning start up date	Drive commissioned startup date.
Application	Application where the drive is used (for example, Spinning).
Criticality in process	Criticality of the application based on the time required to stop the drive in the event of a fault. Low - No direct impact Medium - Delayed stop High - Immediate stop
Industry	Industry where the application is in use.

6. Check and accept the Terms and conditions, and click **Next**.
7. Check the summary of registered information and click **Save**.

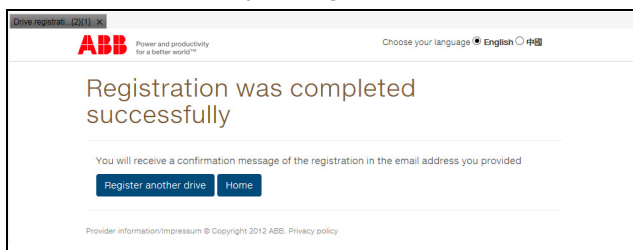

Figure 182. Registering drive completed

The “*Registration was completed successfully*” message is displayed. You will also receive an email to the registered email address

■ Searching a registered ABB drive in Drive Installed Base

You can search for information about an ABB drive that is registered in Drive Installed Base service portal. **Note:** Make sure you have access permissions to Drive Installed Base service portal.

1. From drive context menu select **Search drive from DIB** or go to **Tools** → **Search drive from DIB**.

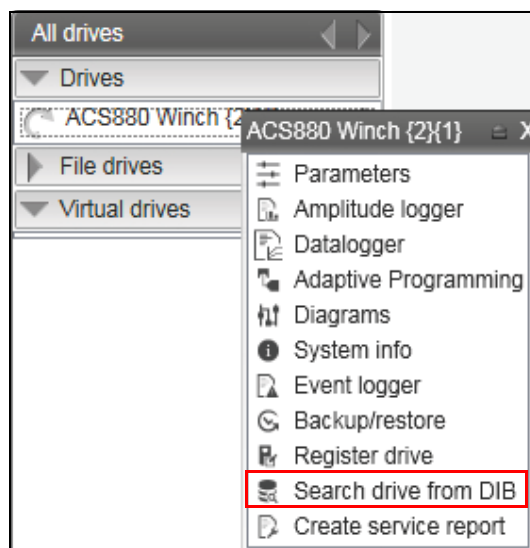

Figure 183. Search drive from Drive Installed Base

- If you used the drive context menu, Drive Composer extracts the drive serial number directly from the connected drive. Otherwise the “*Drive has not got serial number*” message is displayed.
 - If you used **Tools** → **Search drive from DIB**, Drive Composer asks for serial number.
2. Type the serial number and click **Ok**.

Figure 184. Search drive from Drive Installed Base: enter serial number

- If the serial number matches with the drive data in Drive Installed Base, Drive Composer downloads all data related to the drive and opens in a separate tab.

DIB 1114604592 x			
Product info	Service history	Recommended services	Components
Serial Number	1114604592	Drive Status	
Short Type Code	ACS880-01-05A6-3	Warranty Status	Expired
Long Type Code	ACS880-01-05A6-3	End of standart warranty	2013-11-21
Manufacturer	9AAE201034	End of extended warranty	
Manufacturing Date	2011-11-14	Industry	
Delivery Date	2011-11-21	Application	CRA
Commissioning Date	2018-04-05		

Figure 185. Search a drive from Drive Installed Base: Product info tab

- If you typed a wrong serial number or if the drive was not registered in Drive Installed Base, the message “Authorization failed, do you want to log in again” or “Drive has not got serial number” is displayed.

3. Click **Product info**, to view the drive information, for example, serial number, type code, commissioning date, etc.
4. Click **Service history**, to view the maintenance history of the drive, for example, event or service type, date of service, name of service engineer, etc. You can download the attached service report file, if the file was added to the report.

Serial	Event	Date	Service provider	Service engineer	Created	Report file
1114604592	Registration	05-Apr-18	ABB India Limited	Hari Prasad	04-May-18	

Figure 186. Search drive in Drive Installed Base: Service history tab

5. Click **Recommended services**, to view the recommended drive services.

Code	Description	Type	Est. hours
PM6Y550R14	ACX550-01-02A4-4_012A-4 IP21	PM6	2

Figure 187. Search drive in Drive Installed Base: Recommended services

6. Click **Components**, to view the details of service components.

Component Code	Description	Serial Number
3AUA0000082152	ACS880-01-05A6-3	1114604592
3AUA0000080539	BASE UNIT ACS880-01 SBU-1A	F1440049VS
3AUA0000064885	CONTROL PANEL ACS-AP-I MODULE	A1251067SB
3AUA0000087753	WIRINGACCESSORIES ACS880-01 R1-R2 IP21	18.11.2011
3AUA0000080634	MEMORY UNIT ZMU-01	A1380509VS
FIRMWARE		AINF0100 /N2000
SOLPRGRM		N/A
TECHLIB		N/A
CUSTSPEC		N/A
S/N CHECKSUM		U
S/N CHECKSUM ID		N/A
GROUP ID		N/A

Figure 188. Search drive from Drive Installed Base: Components tab

■ Setting the Drive Installed Base server location

The drive data is stored only in two server locations: Europe and China. The default location is Europe. For drives located in China, select China and for drives located in countries other than China, select Europe.

1. Go to **View** → **Settings**.
2. In the Settings window, select the appropriate Drive Installed Base server location. Example: Europe.

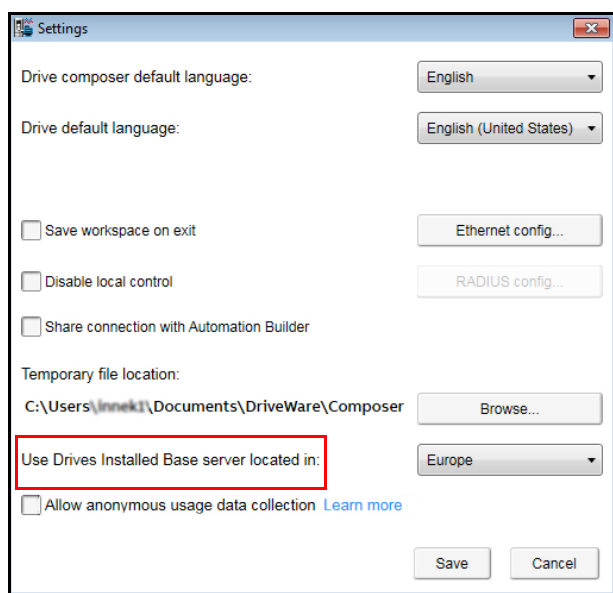

Figure 189. Settings: Use Drive Installed Base server location

3. Click **Save**.
The Drive Installed Base server location is set to the selected country.

■ Creating a service report from Drive Installed Base

You can create a service report for an ABB drive registered in Drive Installed Base, if you have access permissions to the Drive Installed Base portal.

Note: The service report templates are predefined. However, if it is necessary to change the template, contact your local ABB representative.

1. Click on the drive list, select **Create service report** or go to **Tools** → **Create service report**.

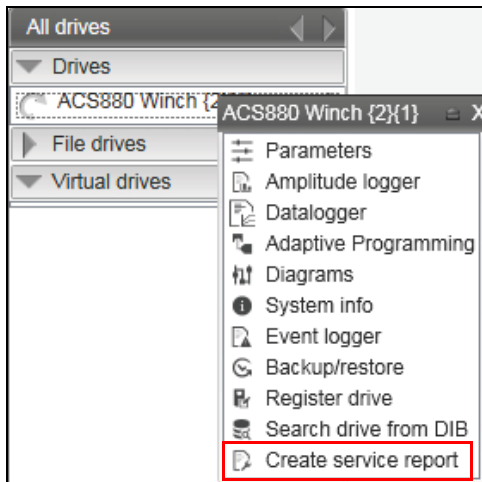

Figure 190. Create service report from Drive Installed Base

2. In the Service reporting page, click Select.

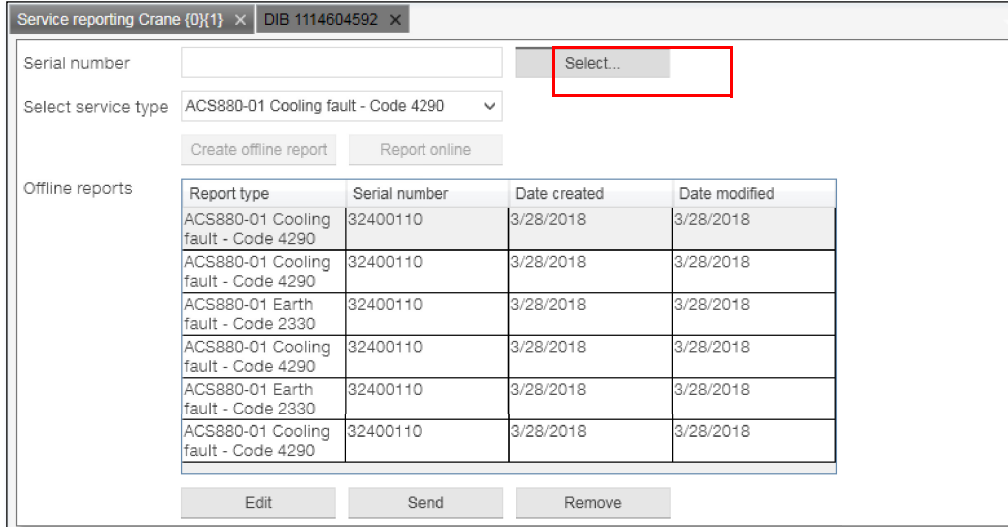

Figure 191. Service report page: Select drive serial number

3. Select the appropriate drive. Click **Ok**.

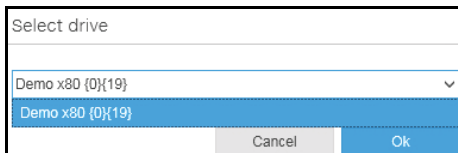

Figure 192. Service report page: Select drive type

4. In the Service reporting page, type the drive serial number.

- In **Select service type** field, select the necessary service type, for example, *ACS880-01 Cooling fault - Code 4290*.

Note: Drive Composer downloads the selected service type. If downloading failed due to network error, you can use the previously downloaded Service pack.

- If the registered drive serial number and service type matched with the Drive Installed Base data, you can [Create online service report](#) or [Creating offline report](#). See sections below.

■ Create online service report

Note: The contents in the report page are based on the service type and some contents in the wizard may be filled with information from the drive if the serial number matched with the drive.

In the below steps, see an example report of *ACS880-01 Cooling fault*.

- Click on the drive list, select **Create service report** or go to **Tools** → **Create service report**.
- Wait while Drive Composer connects to the Drive Installed base.
- In the service reporting page, click **Select** to select a connected drive or enter the drive serial number.
- Click **Report online**.

Report type	Serial number	Date created	Date modified
EN !Generic Health check	3240010	5/9/2019	5/9/2019
EN !Generic Health check	3240010	5/9/2019	5/9/2019
EN !Generic Commissioning	7360010	5/9/2019	5/9/2019

Figure 193. Create online service report: Report online

- In the General Info page, fill the necessary information. Click **Next**.

Note: All mandatory fields in this page and in the consecutive pages are marked with an asterisk (*) and appear with a red border around each field.

General Info

ACS880-01 Cooling fault - Code 4290

Equipment info

Drive Serial Number 32400110

Drive Type Code PCB, CT BOARD

Application Spinning

Service engineer

Name ABB

e-mail abb@in.abb.com

Report info

Service event Repair

Reporting date 28-Mar-18 12:08 PM

BOL Reference Number 12345

Service visit start date 28-Mar-18 12:08 PM

Print Cancel Back Next Send

Figure 194. Create service report: General Info page

- In the End customer page, type details of location where the drive is installed. Click **Next**.

End customer

End Customer Information

End customer name XYZ

City Bangalore

Region

Country India

Site Name Spinning mill *

Address

ZIP Code 560048 *

Contact Person ABB *

Email Address abb@in.abb.com| *

Telephone 1234567890 *

Print Cancel Back Next Send

Figure 195. Create service report: End customer page

- In the Fault page, select the appropriate date when the fault occurred. You can update information of up to four fault codes. Click **Next**.

Fault

Fault 1

Date of fault

Fault code

Warranty order number (required if fault under warranty)

Description of fault

Fault 2

Date of fault

Fault code

Warranty order number (required if fault under warranty)

Description of fault

Fault 3

Date of fault

Fault code

Warranty order number (required if fault under warranty)

Description of fault

Figure 196. Create service report: Fault Info page

8. In the Onsite check list, check and confirm that all actions are completed. All actions in this list are mandatory. Click **Next**.

Onsite check list

ACS880-01 Cooling fault - Code 4290

- Check if the firmware is up to date
- Check motor power against drive power.
- Check setting of acceleration and deceleration times
- Check ambient conditions
- Check air flow and fan operation (correct fan direction)
- Check heatsink fins for dust pick-up.
- Check if the motor cable are not too long >300m
- Check condition of motor cables
- Check thermal grease condition
- Check if there are no air gaps between IGBT and heatsink surface

Print Cancel Back Next Send

Figure 197. Create service report: Onsite checklist page

9. The consecutive pages for Material data are optional. You can fill up to five material data. Type the information if necessary and click **Next**.

Material 1 (Optional)

Type

Code

Part number

Old serial number

Serial number

Quantity

Source

Installed

LongLifeFan

Description

Print Cancel Back Next Send

Figure 198. Create service report: Material Info page

10. In the Components list, confirm that the listed components are available in the drive. Check against the listed component to report to Drive Installed Base service. Click **Send**.

Components

Display list of components with old serial nr

Components

Version	Description	Component code	Old serial number	New serial number	Action	Position	Report to DIB
	ACH401C00635+B0DE0000	3AUA0000000438	2024100967				<input checked="" type="checkbox"/>
	ACH401C00635	3AUA64371762	2024001487				<input checked="" type="checkbox"/>
	PCB, SNAT 4133	3AFE63992933	63992933R2334060				<input checked="" type="checkbox"/>
	CIB MOD, 12KV 25A	3AFE63989134	N00DA9				<input checked="" type="checkbox"/>
	PCB SNAT 4041	3AFE63993026	63993026U2370297				<input checked="" type="checkbox"/>
V.1.1.3.7	Test software	TESTSW	V.1.1.3.7				<input checked="" type="checkbox"/>
V.1.1.3.7	Release software	DELIVSW	V.1.1.3.7				<input checked="" type="checkbox"/>
	LABEL, UL, ENCLOSED PNL S.N	3AUA294001B350	BC242928				<input checked="" type="checkbox"/>
	PCB, CONTROL BP @@F11	3AUA489002B6112	B2390148				<input checked="" type="checkbox"/>
	PCB, MAIN CKT BD EBP	3AUA489002B5217	82390079				<input checked="" type="checkbox"/>
	PCB, CT BOARD	3AUA489002B5218	32400110				<input checked="" type="checkbox"/>

Figure 199. Create service report: Components list

11. Read and accept the privacy terms and conditions. Click **Next**.

Privacy notice summary

ABB considers privacy an important issue, so we build and operate our online services with the protection of privacy taken into account.

This Privacy Policy ("Notice") sets out the types of personal information we collect from you when you use our website, how we collect and process that information, who we share it with and certain rights you have in relation to that information. This Notice applies to this website new.abb.com which is owned and operated by ABB Asea Brown Boveri Ltd and any other websites operated by ABB which point to this Notice.

For more information about how we are using your personal data and your legal rights in relation to this personal data, please click on "view full privacy notice":

View full privacy notice ▼

By activating you accept the Privacy Terms and Conditions.

Figure 200. Privacy terms and conditions

12. If report is sent, the message "Sending to Drive Installed Base completed" appears. Click **OK**.

Information

 Sending to Drives Installed Base completed

If report sending failed, Drive Composer prompts to save the report as Offline reports, which you can try sending later. See [Creating offline report](#).

■ Creating offline report

Note: The contents in the report are based on the service type and some contents in the wizard may be filled with information from the drive if the serial number matched with the drive.

1. In the service reporting page, click **Create offline report**.

A service report is generated and appears in the Offline reports table.

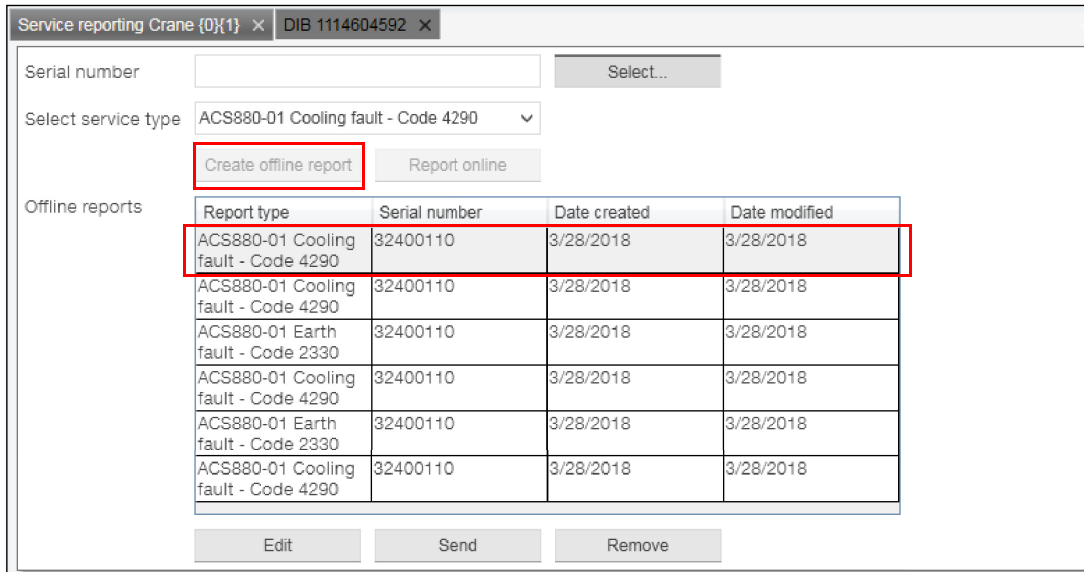

The screenshot shows a web interface for service reporting. At the top, there are two tabs: 'Service reporting Crane {0}{1}' and 'DIB 1114604592'. Below the tabs, there is a 'Serial number' input field with a 'Select...' button. A dropdown menu for 'Select service type' is set to 'ACS880-01 Cooling fault - Code 4290'. Below this, there are two buttons: 'Create offline report' (highlighted with a red box) and 'Report online'. Underneath is a table titled 'Offline reports' with the following data:

Report type	Serial number	Date created	Date modified
ACS880-01 Cooling fault - Code 4290	32400110	3/28/2018	3/28/2018
ACS880-01 Cooling fault - Code 4290	32400110	3/28/2018	3/28/2018
ACS880-01 Earth fault - Code 2330	32400110	3/28/2018	3/28/2018
ACS880-01 Cooling fault - Code 4290	32400110	3/28/2018	3/28/2018
ACS880-01 Earth fault - Code 2330	32400110	3/28/2018	3/28/2018
ACS880-01 Cooling fault - Code 4290	32400110	3/28/2018	3/28/2018

At the bottom of the interface, there are three buttons: 'Edit', 'Send', and 'Remove'.

Figure 201. Offline report

2. Select the report and do the necessary actions:
 - Click **Edit**, if it is necessary to modify the report. See section [Create online service report](#) (step 3 onwards).
 - Click **Send**, if the report is ready to send to Drive Installed Base.
 - Click **Remove**, to delete a report. Confirm the message “*The offline report has not been sent to Drive Installed Base. Are you sure you want to remove it and lose all changes?*”
3. If you clicked **Send**, read and accept the privacy terms and conditions. Click **Next**.

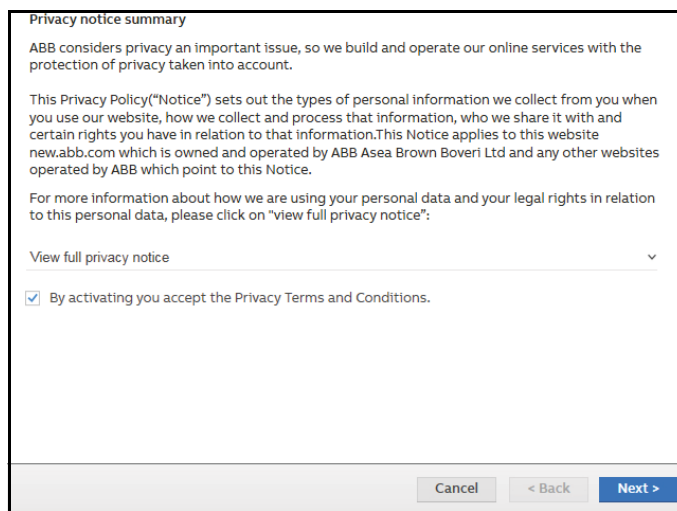

The screenshot shows a 'Privacy notice summary' dialog box. The text inside reads:

ABB considers privacy an important issue, so we build and operate our online services with the protection of privacy taken into account.

This Privacy Policy (“Notice”) sets out the types of personal information we collect from you when you use our website, how we collect and process that information, who we share it with and certain rights you have in relation to that information. This Notice applies to this website new.abb.com which is owned and operated by ABB Asea Brown Boveri Ltd and any other websites operated by ABB which point to this Notice.

For more information about how we are using your personal data and your legal rights in relation to this personal data, please click on “view full privacy notice”:

View full privacy notice

By activating you accept the Privacy Terms and Conditions.

At the bottom, there are three buttons: 'Cancel', '< Back', and 'Next >'.

Figure 202. Privacy notice summary

4. If report is sent to Drive Installed Base service portal, the message “*Sending to Drive Installed Base completed*” appears. Click **OK**.

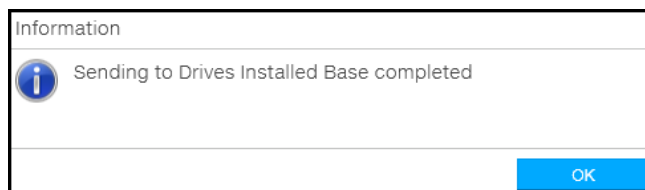

Figure 203. Report sent to drives installed base

If report sending failed, Drive Composer prompts to save the report as Offline reports, which you can try sending later.

Recovery and prevention of FB14 fault in drive

When the fault FB14 is active, the drive's control panel displays the fault message (see figure below).

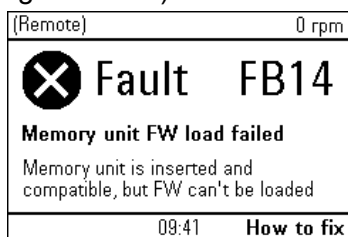

Figure 204. Control panel display of FB14 fault

Drive Composer can be used to remedy this fault by:

1. recovering the drive (see [FB14 Recovery pack](#)) and
2. preventing the fault (see [FB14 Service pack](#)).

You can check the status of Service pack installation in the **System info** window. See [Checking the status of Service pack](#) (page 195).

■ FB14 Recovery pack

1. If there is FB14 fault active in the drive, Drive Composer detects this and prompts to recover the fault using FB14 Recovery pack. Click **Start downloading** to run the Recovery pack. Follow instructions in the note and wait while downloading is in progress.

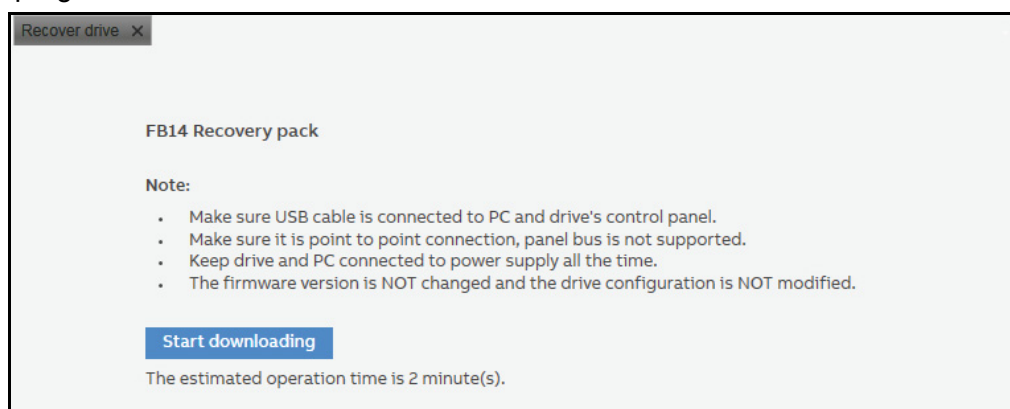

Figure 205. FB14 fault active

Note: If downloading the Recovery pack failed, follow instructions in [FB14 Recovery and Service pack failure](#).

2. After installation is completed, drive is recovered and FB14 fault is reset.

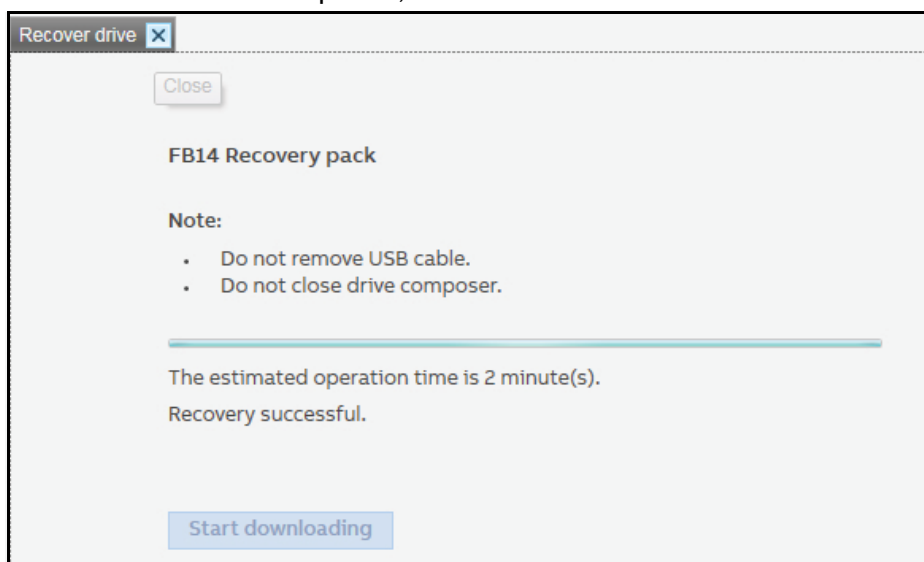

Figure 206. FB14 Recovery pack successful

The drive may be functional now, but the fault root cause still exists in the drive. Proceed with installing *FB14 Service pack*, to completely prevent the FB14 fault.

■ FB14 Service pack

3. In the Recover drive window, click **FB14 Service pack**.

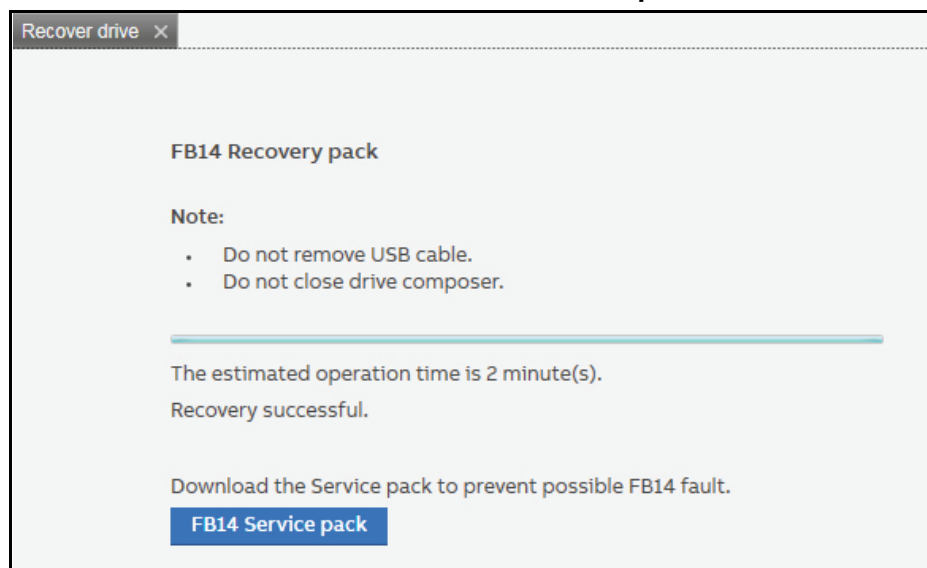

Figure 207. Download FB14 Service pack

- In the FB14 Service pack window, click **Continue**. Follow instructions in the Note.

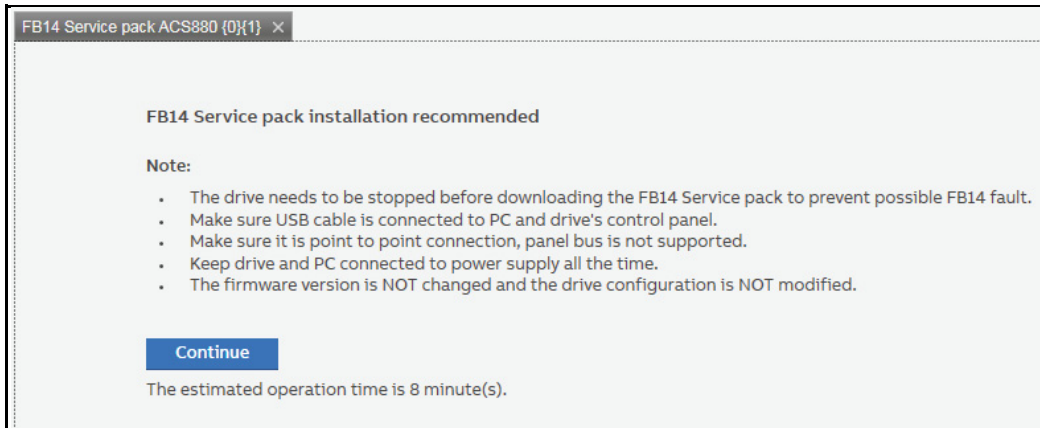

Figure 208. Install FB14 Service pack

- Before installing the Service pack, Drive Composer creates a parameter backup. Check **Parameter backup**.

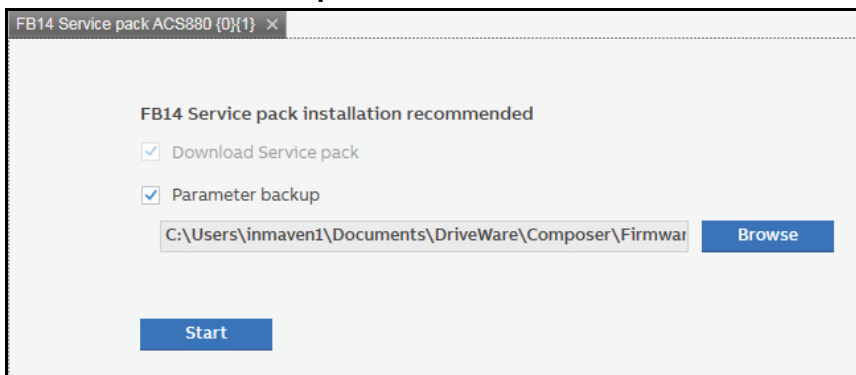

Figure 209. FB14 Service pack installation

- If you prefer to change the backup folder, browse to select a new folder and click **Start**.

WARNING! Do not interrupt the drive during backup and loading process, this may cause severe damage to the drive.

- Wait while Drive Composer completes parameter backup and downloading. Follow instructions in the note.

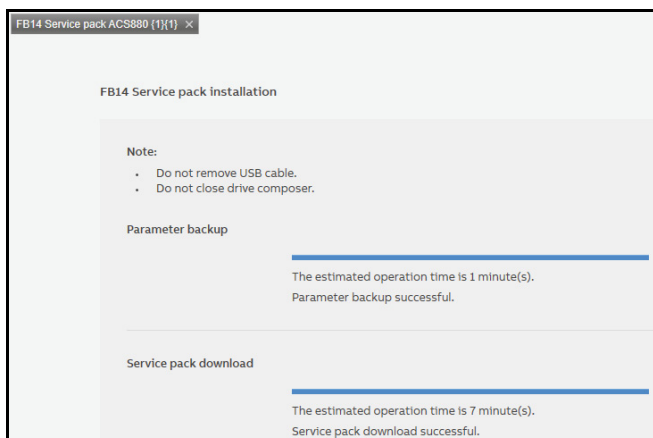

Figure 210. FB14 Service pack installation completed

8. After installation is complete, Drive Composer sends the Service pack update event to ABB server. Later this information is maintained in the Drives Installed Base. Click **Next**.

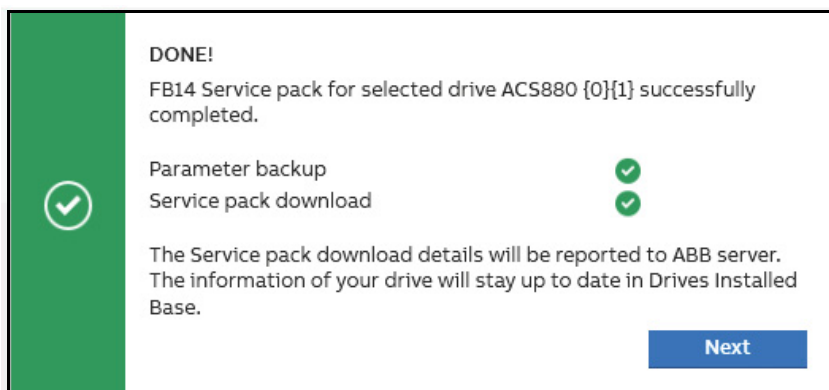

Figure 211. FB14 Service pack installation DONE!

9. A thank you message appears to acknowledge the Service pack installation. You can continue using the drive with the parameter backup saved in your PC. To access the saved location, click on the link **Open file location**.

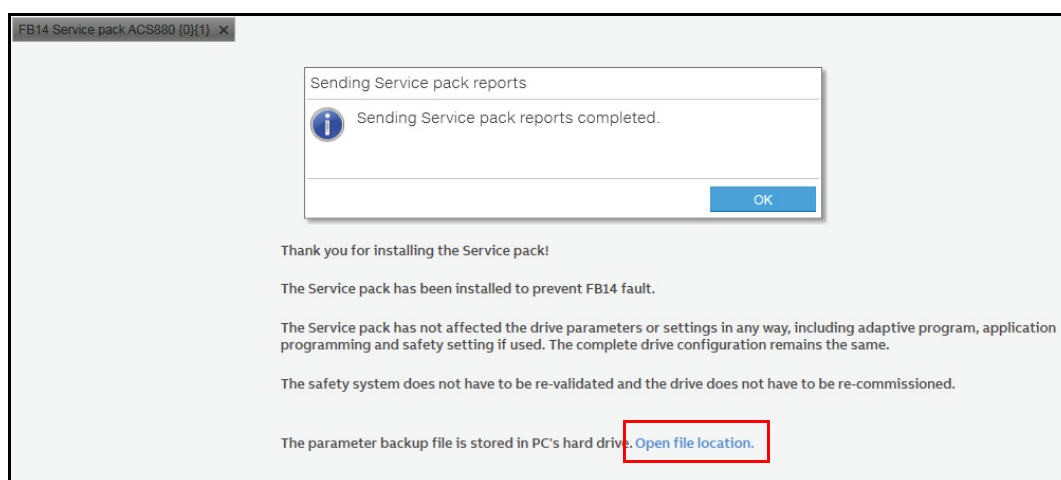

Figure 212. Send Service pack report

See also,

- [Sending offline FB14 Service pack event](#)
- [FB14 Recovery and Service pack failure](#)
- [Checking the status of Service pack](#)

■ Sending FB14 Service pack event

After the FB14 Service pack installation and update is completed, Drive Composer automatically sends the service information to ABB server. The server is updated periodically to transfer the service information to Drives Installed Base (Drive Installed Base) in which the Drive history is maintained. See figure [FB14 Service pack installation DONE!](#)

■ Sending offline FB14 Service pack event

If network was offline during FB14 fault remedy, the “.... no connection to ABB server” message appears. Drive Composer saves the event report locally and confirms if the report can be sent at the next start whenever the drive is online.

■ FB14 Recovery and Service pack failure

If the Recovery and Service pack process failed, Drive Composer opens the default mail client with filled message, for example, drive ID and Drive Composer version. You can check the filled details and send the mail to ABB global technical support to help diagnose the cause of failure.

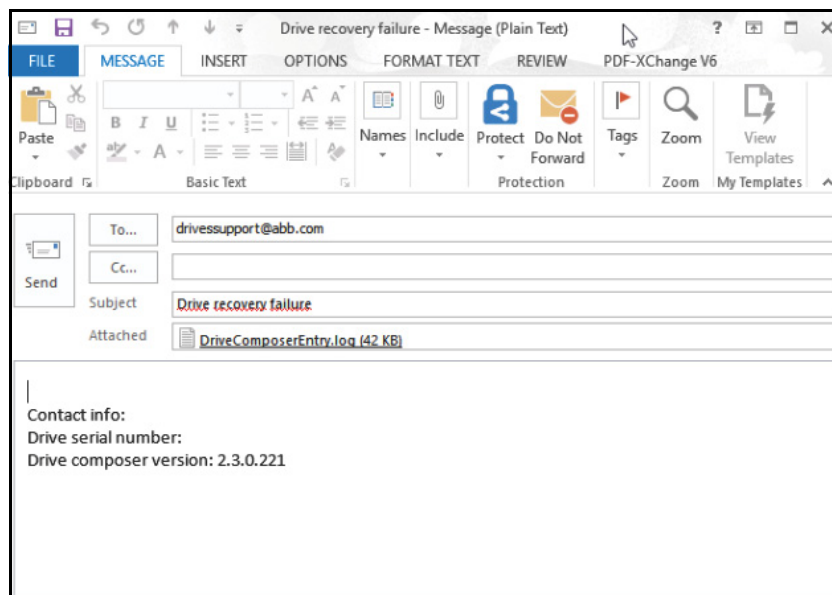

Figure 213. FB14 Recovery and Service pack failure: email notification

Note: Drive ID is filled only when the Service pack installation fails. Drive Composer attaches the log file to the mail. But you can also attach the backup file.

■ Checking the status of Service pack

You can check the status of Service pack installation from the System info window.

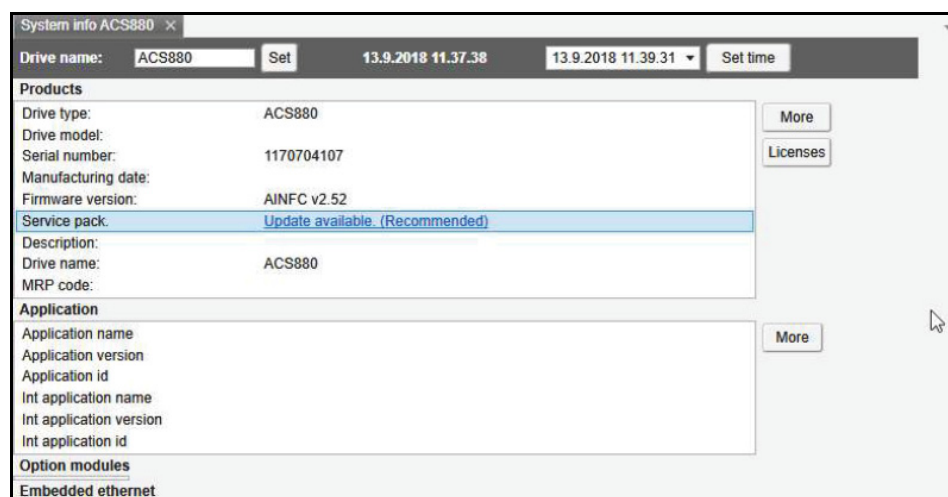

Figure 214. System info: Service pack update status

The following status appears in the System info window:

Status	Description
Update Available (Recommended)	<p>indicates that the drive requires Service pack installation. ABB recommends to install the Service pack to prevent any possible fault in the future.</p> <p>To install,</p> <ol style="list-style-type: none"> 1. Click on the status. <p>Note: Make sure that the drive is powered on and USB cable is connected between drive control panel and PC.</p> <ol style="list-style-type: none"> 2. Follow the instructions on how to proceed with installation. See, FB14 Service pack, step 7 onwards.
Updated	indicates that Service pack is installed in the drive, and no further action is required.
Not Required	indicates that the memory unit or drive firmware includes the FB14 fault remedy and drive does not require Service pack installation.

Using the Drive text editor

You can manage user editable texts using the Drive text editor. The function allows to read texts from the drive, to make changes and to update texts to the drive.

1. Select **Tools** → **Drive Text Editor**.

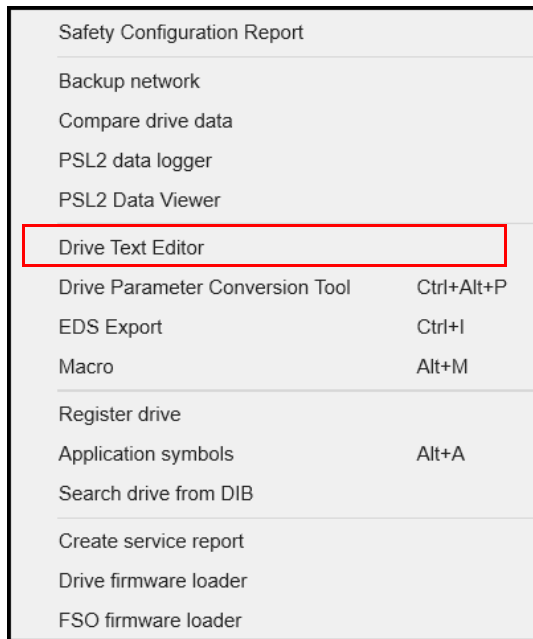

Figure 215. Drive text editor

2. Select the drive to work with and click **Ok**.

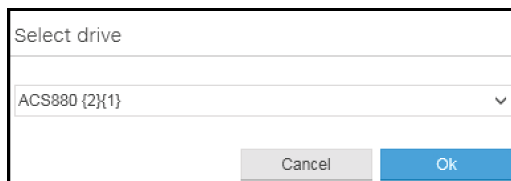

Figure 216. Drive text editor: Select drive

The Drive text editor is started and attached to the selected drive.

- Click **Read**, to read the data from the drive and make the changes in the column **Localized text**. Also, select the **Enable** check box to display the contact information in the panel.

Notes:

- The changed text appears as highlighted until it is saved.
- The contact info appears in the preview even if the **Enable** check box is not selected.

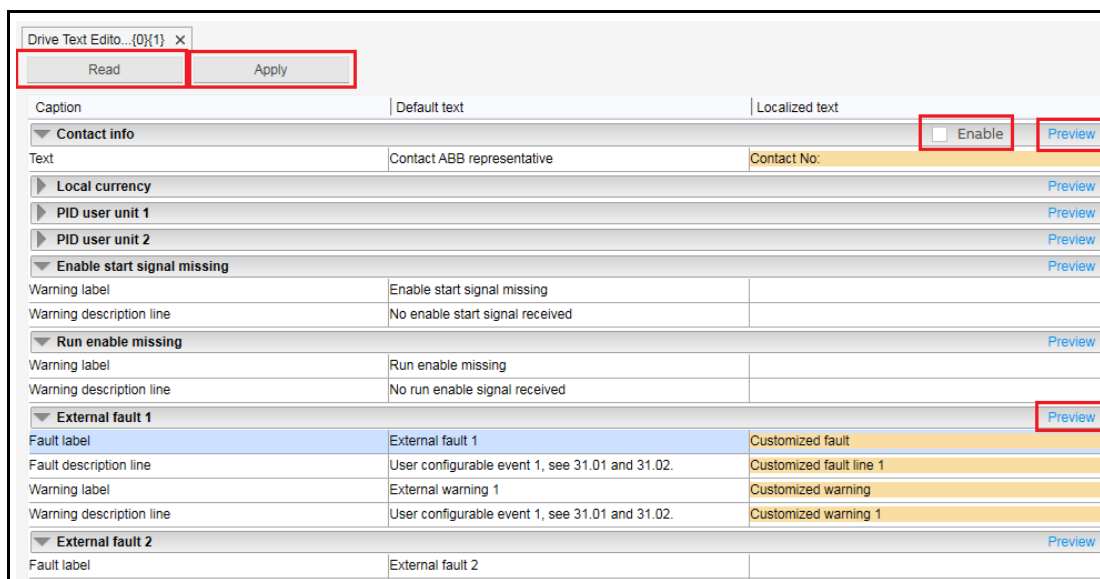

Figure 217. Drive text editor: Localized text

- Click **Preview**, to review the changes.

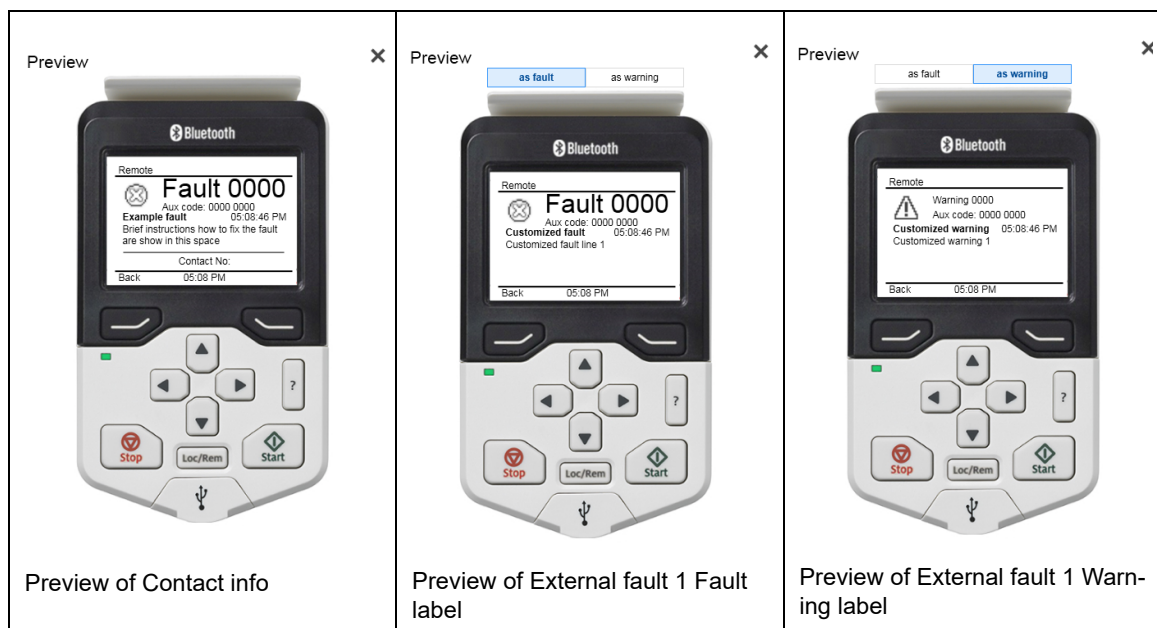

Figure 218. Drive text editor: Preview localized text

5. In the Drive text editor window, click **Apply**.

The changes are written to the drive and the message *Parameters changed. Parameters are reloaded* appears.

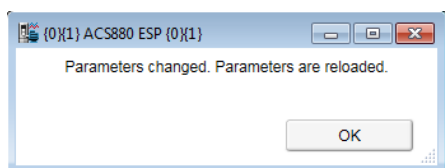

Figure 219. Drive text editor: Parameters changed successfully

6. Click **OK**.
-

Using the Drive parameter conversion tool (pro)

The parameter files of ACS800/ACS600 ABB drive types commissioned and maintained with DriveWindow can be accessed with Drive Composer via the Drive parameter conversion tool.

Note: Not all ACS800/ACS600 drives and software are supported.

1. Go to **Tools** → **Drive parameter conversion tool**.

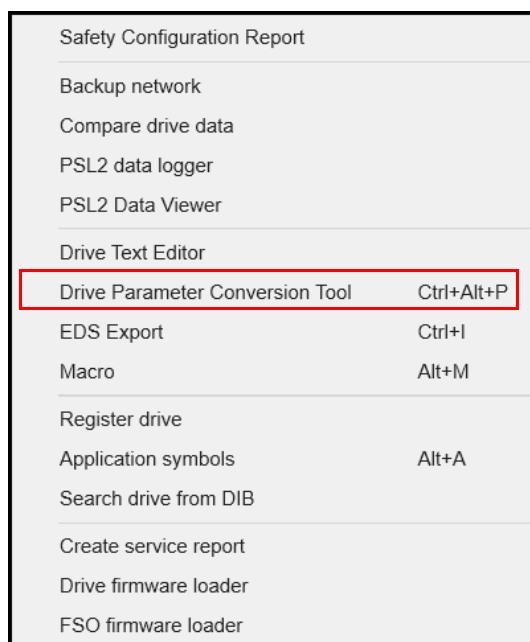

Figure 220. Drive parameter conversion tool

2. In the Drive Parameter Conversion Introduction screen, click **Next**.

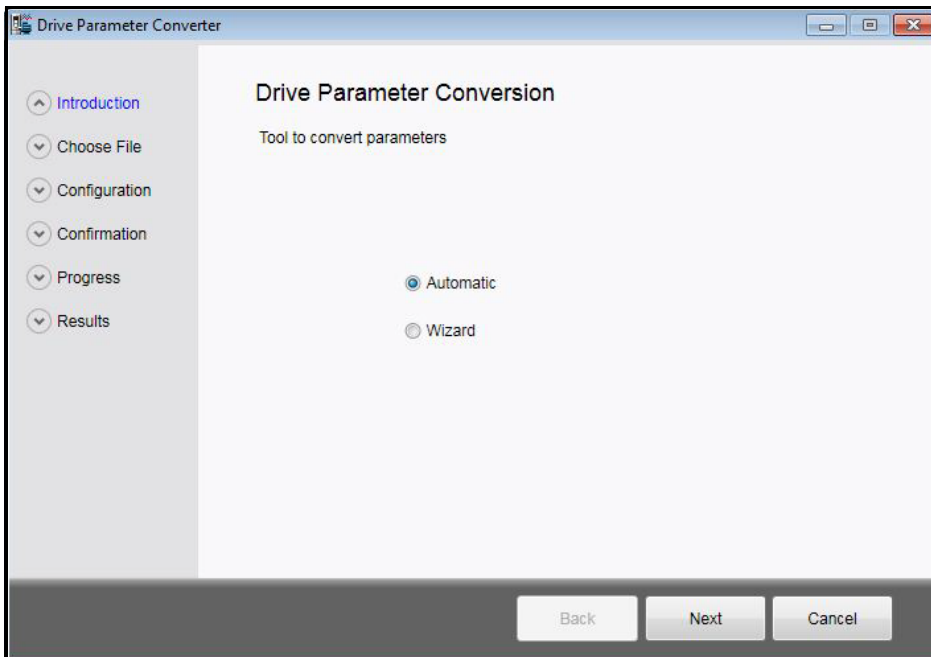

Figure 221. Drive parameter conversion: Introduction

3. Browse and select appropriate source and destination drive parameter files.

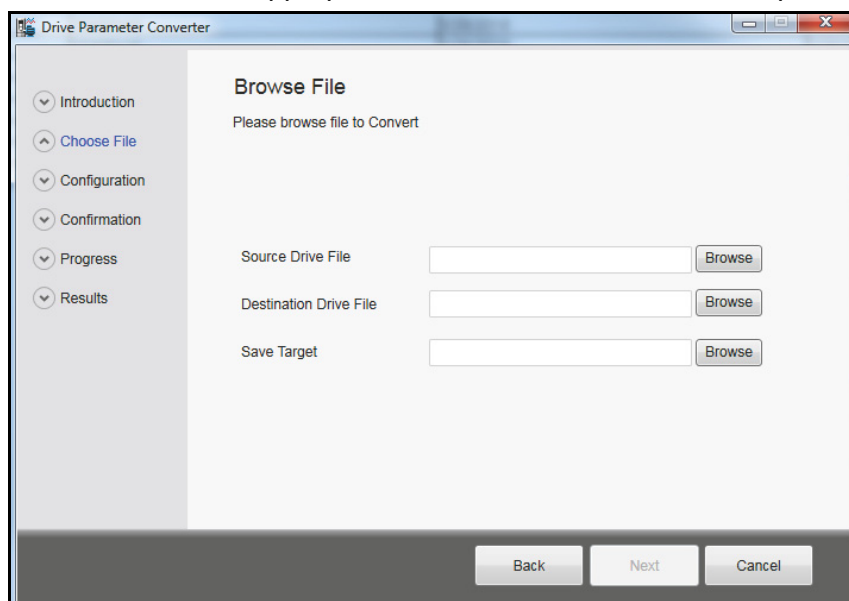

Figure 222. Drive parameter conversion: Browsing source and destination file

Note: Select an empty parameter file with default values. You must create an offline parameter file (of the destination drive family) to select here.

4. Select a file name to save the target file. Click **Next**.

Note: Do not overwrite the empty file.

5. Answer **Yes**.

The Conversion report shows the parameters which are converted successfully and failed. Read the report carefully and fix the parameter values manually for which the conversion was not successful.

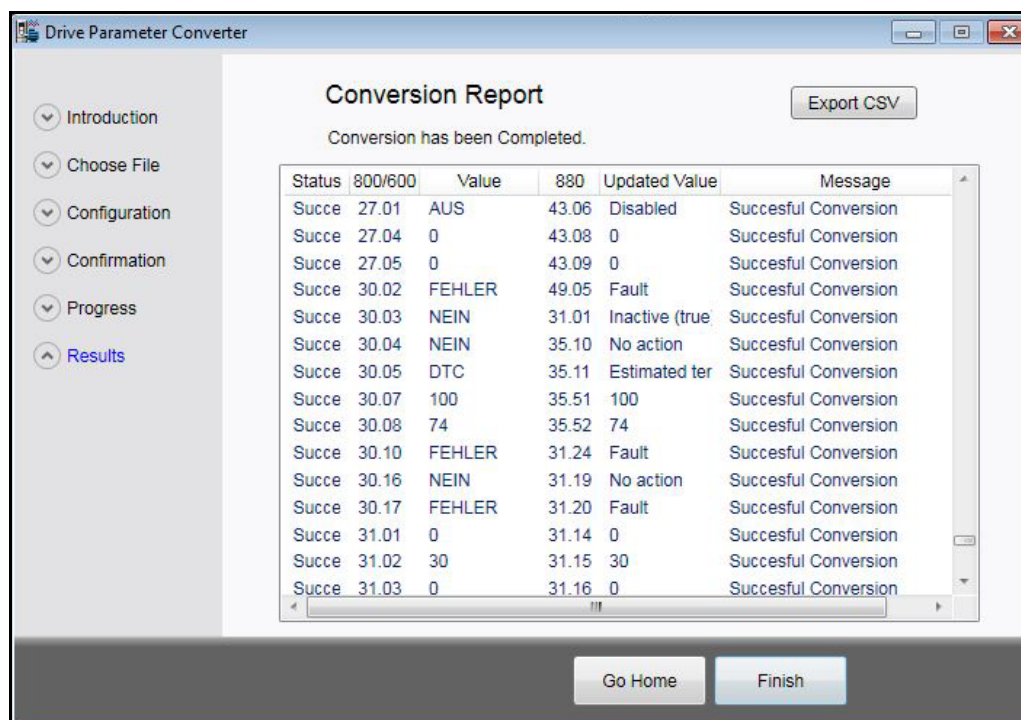

Figure 223. Drive parameter conversion: Results

Using the PSL2 data logger (pro)

With BCU-x2 control unit, you can upload the PSL2 data logger files from the drive flash memory to PC local hard drive. The files contain real time data from the converter modules that help in fault tracing and analysis.

Note: The files can be uploaded from drive to local computer only. You cannot read the contents or open the files. For any further assistance contact ABB customer support.

■ Uploading PSL2 data logger files

1. Go to **Tools** → **PSL2 data logger**.

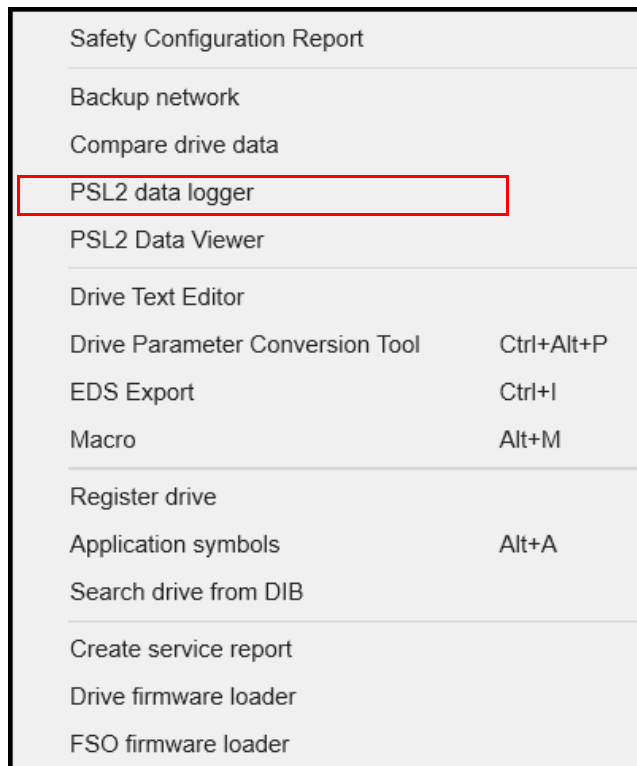

Figure 224. PSL2 Data logger

2. Move the PSU data logger file(s) that you want to upload to the right side box. Use the right arrow (>>) or the left arrow (<<) button.

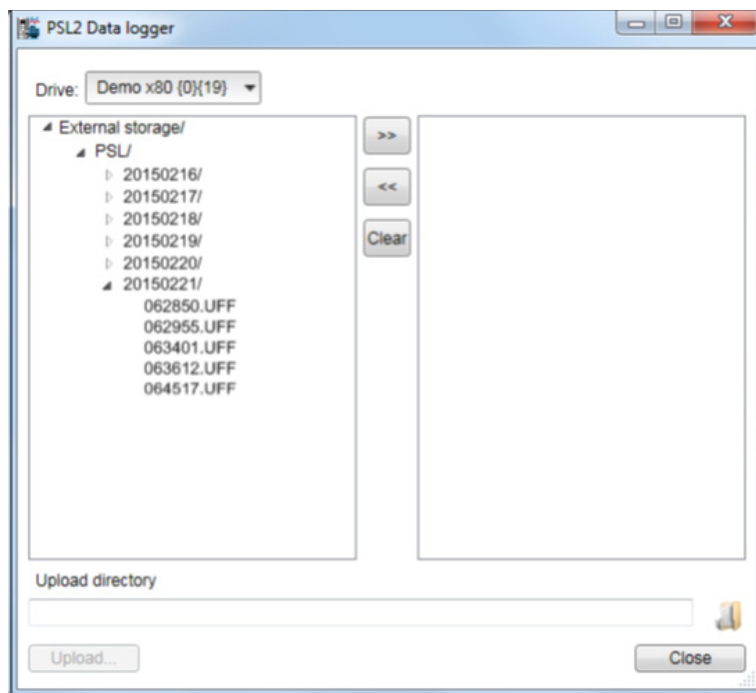



Figure 225. PSU datalogger file: select files

3. In the Upload directory field, click  and select an upload folder in your PC local hard drive.
4. Click **Upload...**
The selected files are transferred to your local folder.

Using the PSL2 data viewer (pro)

You can open and view contents of the uploaded PSL2 data logger files in the PC local hard drive. The files contain real time data from the converter modules that help in fault tracing and analysis.

■ Viewing PSL2 data logger files

1. Go to **Tools** → **PSL2 Data Viewer**.

PSL2 Data Viewer screen with PSL2 plotting tools appears. The plotting area is empty by default. See [PSL2 Data Viewer instructions](#) below to open and save the plot.

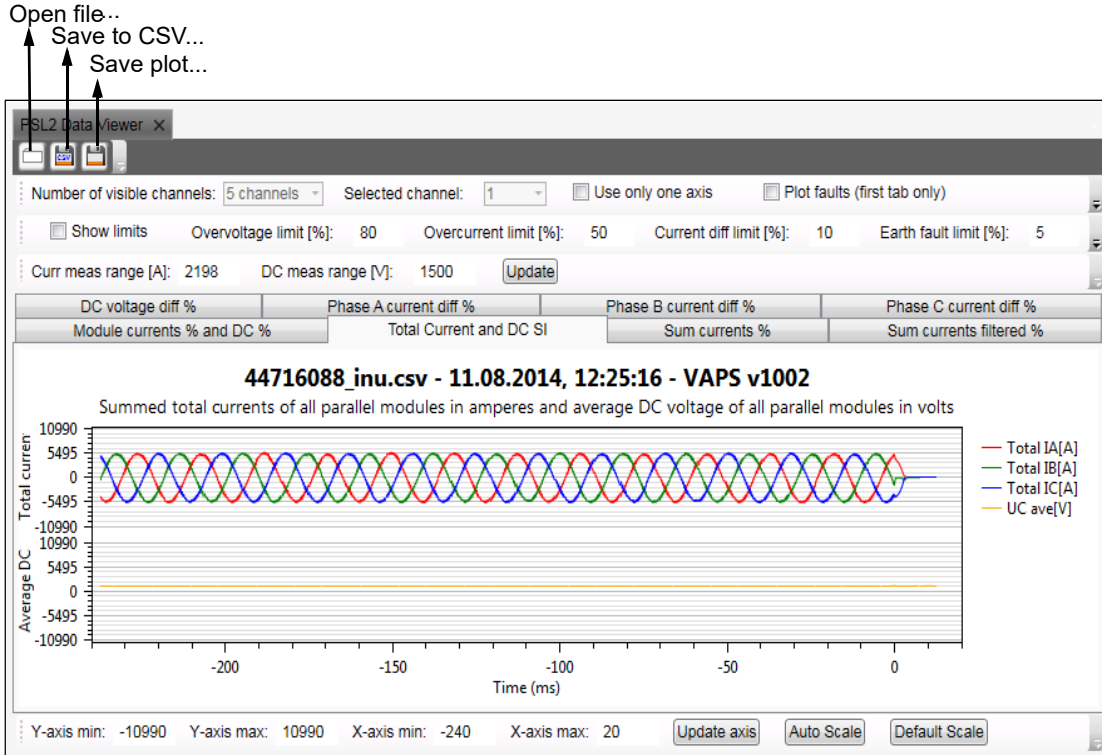

Figure 226. PSL2 Data viewer screen

■ PSL2 Data Viewer instructions

The PSL2 plotting tools can be used to plot current and DC voltage using the *uff* or *csv* file. The table below describes how to use the plotting tools. Match the below instructions with the above [PSL2 Data viewer screen](#).

Action	Instruction
Opening <i>uff</i> or <i>csv</i> file.	In the PSL2 Data Viewer window, click Open file icon and select the file to open.
Saving the plot as csv file.	Click Save to CSV icon.
Saving the plot into different file formats.	Click Save plot icon.
Selecting number of channels to view in the plot.	Select number of channels in the Number of visible channels drop-down list.
Viewing the selected channels.	See in Selected channel drop-down list..

Action	Instruction
Aligning selected channels on the same axis	Click on Use only one axis check box. Use this option to draw all selected channels on the same axis.
Setting minimum and maximum values of X-axis and Y-axis	Set required minimum and maximum values in the below fields and click on Update axis button. <ul style="list-style-type: none"> • Y-axis min • Y-axis max • X-axis min • X-axis max Note: The min/max values of X-axis and Y-axis are equal in all visible plots.
Scaling X-axis and Y-axis automatically	Click on Auto Scale button. The largest and smallest values of data are scaled to Y-max Y-min respectively. Note: This action does not maintain the same scale in every parallel axis.
Resetting min/max values of Y-axis to default values	Click on Default Scale button. The graph is reset to the updated default values.
Updating calculation parameters to plot and recalculate the data	Set current and voltage values in Curr meas range [A] and DC meas range [V] . Click on Update button.
Viewing different plots	Click on the tabs to view the required plot: <ul style="list-style-type: none"> • Total Current and DC SI • Sum currents % • Phase X current diff % • Sum current filtered % • DC voltage diff % • Module currents % and DC %
Inside the plot you can also do the following actions using keypad and mouse:	<ul style="list-style-type: none"> • use the right mouse button to move (pan) the plot up/down. The x-/ y-axis moves accordingly. • use the mouse wheel to zoom the plot. Zooming multiple channels works best when the cursor is placed on an empty space i.e. top of upper axis, below the lower axis, or between the axis. • mark a rectangle with Ctrl+Right mouse button or Ctrl+Left mouse button to zoom the marked area • hold the Left mouse button to view the plot tracker • press 'A' key to reset the axis to set values • press Ctrl+C to copy the bitmap of plot.

Adaptive programming

Adaptive programming is a feature to control the operation of a drive by parameters. Each parameter has a fixed set of choices or a setting range. The parameters make programming easy, but the choices are limited. You cannot customize the operation further.

The Adaptive programming makes easy customizing possible without the need of a special programming tool or language. The program is built of function blocks.

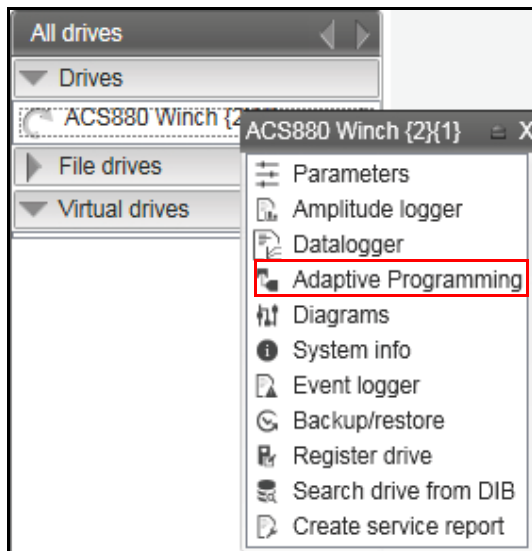

Figure 227. Adaptive programming

For further information on Adaptive programming, refer *Adaptive programming application guide* in [List of related manuals](#).

Locking user interface

A user interface lock function is implemented to notify the device lock states, for example, when parameter system is locked or when file downloading is disabled.



The function prevents you from:

- uploading device data, when file download function is disabled or when parameter system is locked
- creating device backup when the device is in protected state.

The function is implemented in DCPT-01 and DCET-01. See below sections that describe the lock states visible in different pages or views in the Drive Composer.

■ Lock state in System info page

Go to the System info page by right clicking on the selected drive in the drive list and select **System info**. The different lock states displayed in the **System info** page are listed below.



Device lock state	Lock state messages
Initial state	<p>Set button is enabled.</p> 
Parameter system is locked	<p>Set button is disabled. When you mouse hover the button, the tooltip “Parameters are locked on drive” appears.</p> 
File download is disabled	<p>Set button is disabled. When you mouse hover the button, the tooltip “File downloading is disabled on drive” appears.</p> 

■ Lock state in parameter view

The user interface lock states are displayed in the following parameters view:



- Parameters view for online drive (see page [138](#))
- Custom parameter view (see page [150](#))
- Offline parameter view (see page [154](#))
- File parameter view (see page [138](#))

In the parameters view, the device lock states, i.e. Parameter system is locked or the File downloading is disabled, are accessible when you mouse hover the below two buttons:

-  Save parameters to file
-  Download to device

The table below lists the different device states displayed in the parameters view. The example screens are from the custom parameter view.

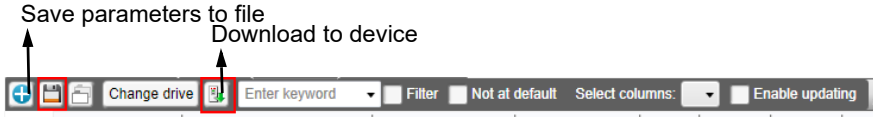
Note: The two buttons listed above may be hidden and may not be visible in all views. When data in the view is loaded for different drives, the drive which is connected may not show the correct state of the buttons until you change the drive.

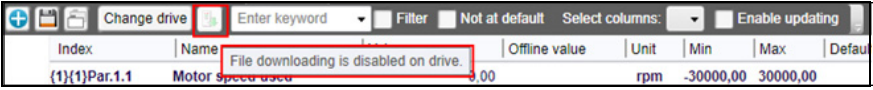
Device lock state	Lock state messages
Initial state	<p>Save parameters to file and Download to device buttons are enabled.</p> 
Parameter system is locked	<p>Save parameters to file button is enabled. Download to device button is disabled. When you mouse hover the disabled button, the tooltip “Parameters are locked on drive” appears.</p> 
File download is disabled	<p>Save parameters to file button is enabled. Download to device button is disabled. When you mouse hover the disabled button, the tooltip “File downloading is disabled on drive” appears.</p> 

Lock state in Backup/Restore page

Go to the Backup/Restore page by right clicking on the selected drive in the drive list and select **Backup/Restore**. The different lock states displayed in the Backup/Restore page are listed below.

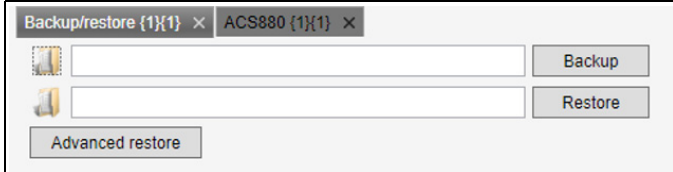
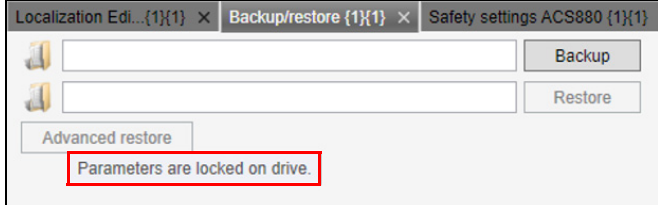
Device lock state	Lock state messages
Initial state	<p>All buttons, Backup, Restore and Advanced restore are enabled.</p>  <p>Note: Advanced restore button is available only in Drive Composer pro, DCPT-01 (code: 3AUA0000108087).</p>
Parameter system is locked	<p>Backup button is enabled. Restore and Advanced restore buttons are disabled. When you mouse hover the disabled buttons, the tooltip “Parameters are locked on drive” appears.</p>  <p>Note: Advanced restore button is available only in Drive Composer pro, DCPT-01 (code: 3AUA0000108087).</p>

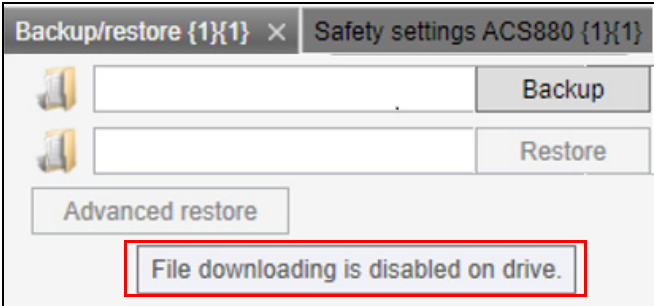
Device lock state	Lock state messages
File download is disabled	<p>Backup button is enabled. Restore and Advance restore buttons are disabled. When you mouse hover the disabled buttons, the tooltip “File downloading is disabled on drive” appears.</p>  <p>Note: Advanced restore is available only in Drive Composer pro, DCPT-01 (code: 3AUA0000108087).</p>

■ **Lock state in Safety settings page (pro)**

Go to the Safety settings page by right clicking on the selected drive in the drive list and select **Safety settings**. The different lock states displayed in the Safety settings page are listed below.

Note: The lock state messages are visible only in Drive Composer pro, DCPT-01 (code: 3AUA0000108087).

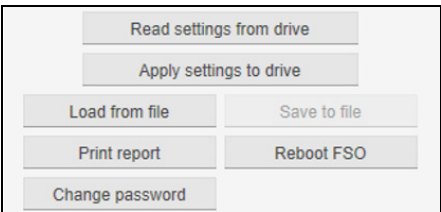
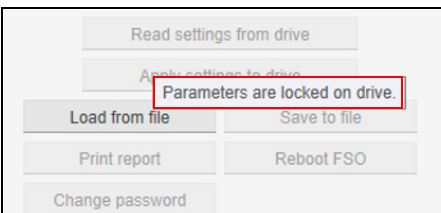
Device lock state	Lock state messages
Initial state	 <p>Buttons enabled:</p> <ul style="list-style-type: none"> • Read settings from drive • Apply settings to drive • Print report • Reboot FSO • Change password. <p>Load from file is always enabled. Save to file is enabled only when data is read.</p>
Parameter system is locked	 <p>Buttons disabled:</p> <ul style="list-style-type: none"> • Read settings from drive • Apply settings to drive • Print report • Reboot FSO • Change password. <p>When you mouse hover the disabled buttons, the tooltip “Parameters are locked on drive” appears.</p> <p>Load from file is always enabled. Save to file is enabled only when data is read.</p>

Device lock state	Lock state messages
File download is disabled	<div data-bbox="404 294 832 495" style="border: 1px solid black; padding: 5px; margin-bottom: 10px;"> </div> <p>Buttons disabled:</p> <ul style="list-style-type: none"> • Read settings from drive • Apply settings to drive • Print report • Reboot FSO • Change password. <p>When you mouse hover the disabled buttons, the tooltip “File downloading is disabled on drive” appears.</p> <p>Load from file is always enabled.</p> <p>Save to file is enabled only when data is read.</p>

■ Lock state in Drive text editor (pro)

Go to **Tools** → **Drive Text Editor**. Select the drive to work with and click **Ok**. The Drive text editor screen appears.

The different lock states displayed in the Drive text editor are listed below.

Note: The lock state messages are visible only in Drive Composer pro, DCPT-01 (code: 3AUA0000108087).

Device lock state	Lock state messages
Initial state	<p>Read button is always enabled.</p> <p>Apply button is enabled only when text is changed in the Localized text column.</p> <div data-bbox="388 1163 1052 1260" style="border: 1px solid black; padding: 5px; margin-top: 10px;"> </div>
Parameter system is locked	<p>Read button is always enabled.</p> <p>If you changed text in the Localized text column, the changes are not effective and the Apply button is disabled. When you mouse hover the disabled button, the tooltip “Parameters are locked on drive” appears.</p> <div data-bbox="388 1431 1075 1563" style="border: 1px solid black; padding: 5px; margin-top: 10px;"> </div>
File download is disabled	<p>Read button is always enabled.</p> <p>If you changed text in the Localized text column, the changes are not effective and the Apply button is disabled. When you mouse hover the disabled button, the tooltip “File downloading is disabled on drive” appears.</p> <div data-bbox="388 1765 1080 1915" style="border: 1px solid black; padding: 5px; margin-top: 10px;"> </div>

RADIUS authentication

■ RADIUS authentication overview

With RADIUS authentication function you can protect drive data by limiting access to certain operations of the drive. The function is accessible via Drive Composer PC tool when the drive is connected to the RADIUS server, for example, via USB or Ethernet connection. The function is activated in the drive with parameter *59.30 Radius authentication enable*. When the function is enabled, Drive Composer will prompt to login to the drive before you make changes to the drive data.

Note: If drive is not enabled with RADIUS authentication function, the drive operations are not limited and all functionalities are available.

For information about the RADIUS server and configuring the drive, see in below sections. See also [Annexure B: Radius authentication](#) (page 229).

■ RADIUS protocol overview

Remote Authentication Dial-In User Service (RADIUS) is a commonly used networking/authentication protocol to manage access to the Internet or internal networks, wireless networks, and integrated e-mail services. The protocol operates using UDP communication with synchronous request-response manner. For more information, see [RADIUS](#) in Wikipedia.

■ RADIUS authentication prerequisites

Make sure

- you are connected to the RADIUS server (Drive Composer ↔ Drive ↔ RADIUS server), for example, via USB or Ethernet connection. See [Example: Network configurations via Ethernet connection](#) (page 230).
 - you have defined the required user access levels to the RADIUS server. See definition of [ABB vendor specific attribute](#) (page 231). Information of all authenticated users is located in the RADIUS server.
-

■ Configuring RADIUS authentication and offline credentials

In Drive Composer, you can configure drive authentication details and offline credentials.

1. Go to **View** → **Settings**.
2. In the Settings window, **Radius config** is enabled if you logged in with *Service* access level. Click **Radius config**.

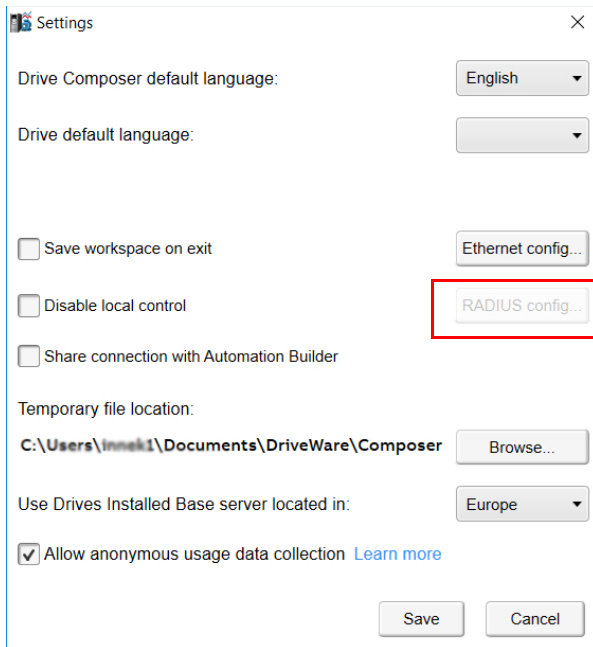

3. In the RADIUS settings window,
 - enter the shared secret password (authentication details). See description below. Default password = *SharedSecret*
 - select target RADIUS server
 - upload offline credential XML file. See description below.

Click **Save**.

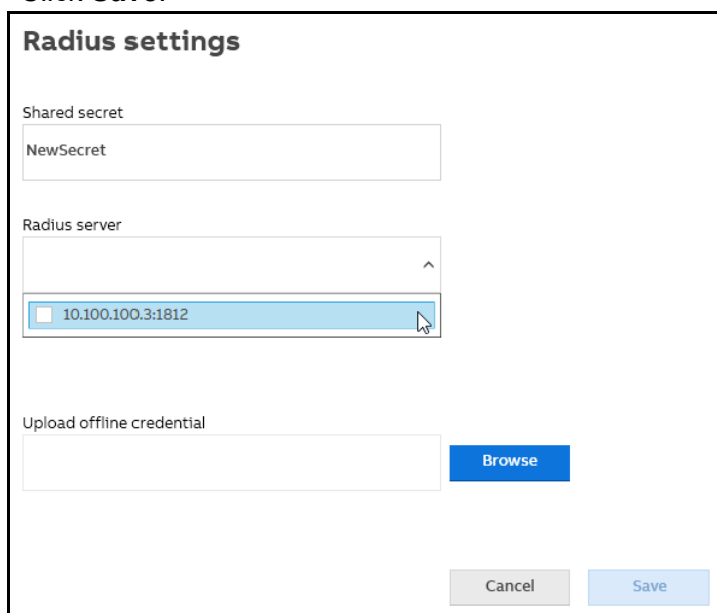

Note: The configuration is effective for all drives using the selected RADIUS server.

Shared secret

Secret password to encrypt the authentication request sent by drive to RADIUS server.

Note: The shared secret password of drive and server should match to correctly process the authentication requests from the server.

Upload offline credentials

- Offline credentials are available in an XML file format and are used as backup to login when the connection to RADIUS server failed and drive failed to authenticate access. If you have the required access level (*Service* level), then you can create a new list of offline credentials and send to the drive via Drive Composer. Go to **View** → **Settings** → **Radius config**.
 - If the drive was able to send the authentication request to RADIUS server within the defined RADIUS communication timeout, then drive will check if given user name and password is available in the offline credentials list. If the credentials matched with that of drive, Drive Composer prompts to login to the drive just like the RADIUS server based authentication.
 - If drive was not able to send the request, e.g. network cable was disconnected, then offline authentication is not executed.

■ Activating RADIUS authentication function

You can enable RADIUS authentication function, when drive authentication feature is disabled.

1. Make sure,
 - the drive is connected to RADIUS server over Ethernet connection. See [Example: Network configurations via Ethernet connection](#).
 - your user access level is *Service*. See [Supported user access levels](#).
2. In Drive Composer's parameter window, configure the following parameters in group *59 Gen Embedded Ethernet*. For more information, see technical document of RADIUS parameters.

Parameter	Description
59.04 Emb Eth IP settings	IP settings, e.g. Static IP
59.05 Emb Eth IP address	IP address of the drive
59.06 Emb Eth subnet mask	Subnet mask of the drive. This value must match with the subnet mask of your PC.
59.07 Emb Eth gateway	Gateway address of the drive used to communicate with other devices in the network. This value is also the IP address of your PC or the router in the network.
59.30 Radius authentication enable	Activates RADIUS authentication function in the drive. The function can be activated only when parameters <i>59.04...59.07</i> have valid values. For example, if IP address is 0.0.0.0, a write failed error occurs while activating the function.
59.32 Radius server IP address	IP address of RADIUS server. Note: The Radius server IP address is not part of the drive parameter backup. Hence, during parameter backup, store the Radius server IP address separately.
59.33 Radius server port	UDP port of RADIUS server

Parameter	Description
59.34 Radius server communication timeout	Delay time (milliseconds) to communicate between the drive and RADIUS server. Note: If delay time is too low, drive authentication to login may fail. Default time = 1500 ms
59.35 Radius server communication retry count	Number of attempts drive failed to communicate with RADIUS server. Note: If this count is too low, drive authentication to login may fail. Default count = 1

If RADIUS authentication function is activated,

- drive moves to unauthenticated state
- drive navigation feature is locked
- Drive Composer closes all drive related views
- Drive Composer prompts to login to the drive before you make any changes to the drive data. See [Login with RADIUS authentication](#).

3. Restart the drive.

■ Disable RADIUS authentication

You can disable RADIUS authentication with parameter 59.30 when you are still logged in to RADIUS server. The authentication and offline credentials are disabled, but the drive will still be in logged in state and you can continue working with the drive.

■ Login with RADIUS authentication

If the connected drive is enabled with RADIUS authentication,

- a lock symbol appears next to the drive icon to indicate that drive is locked for editing and
- a login button appears at the top-right corner. The first drive in the drive list requests authentication. You can also login using the drive navigation list and select the drive to authenticate.

Lock

Login

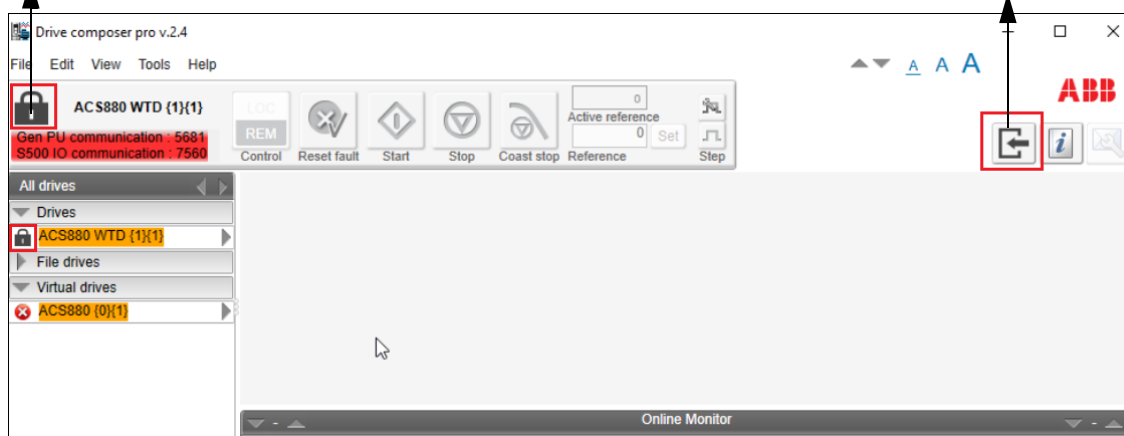

1. Click the **Login** button.
2. In the login window, enter the drive username and password.

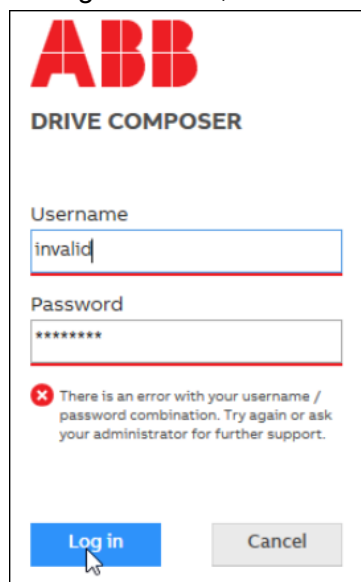

The screenshot shows the ABB Drive Composer login interface. At the top is the ABB logo in red, followed by the text "DRIVE COMPOSER". Below this are two input fields: "Username" containing the text "invalid" and "Password" containing seven asterisks. A red error message with a red 'x' icon is displayed below the fields: "There is an error with your username / password combination. Try again or ask your administrator for further support." At the bottom, there are two buttons: a blue "Log in" button with a mouse cursor pointing to it, and a grey "Cancel" button.

Note: Login is successful only when the credentials of drive match with that of RADIUS server. If the credentials are not matching, you may have to shut down the RADIUS server and login to the drive using offline credentials (i.e. service user access level). For default offline credentials, contact your local ABB representative.

If login was successful:

- drive is accessible and the lock symbol changes to indicate the current drive state
- drive control toolbar is enabled and
- drive related views can be opened.

Note: After successful login to one drive, the same credentials are automatically used to unlock other drives.

■ Drive backup and restore

The RADIUS authentication parameters 59.30...59.35, Shared secret and Offline credentials are not part of drive backup and thus cannot be restored to drive. If a drive is restored from a backup file, the existing values of RADIUS parameters, Shared secret and offline credentials are preserved.

12

Annexure A: Creating Drive Installed Base service report template

Contents of this chapter

This chapter describes the factors to consider when creating a service report template file for Drive Installed Base (DIB).

See topics:

<i>Creating a template for Drive Installed Base service report (Internal use only)</i>	138
<i>Generic wizard step</i>	139
<i>Components</i>	139
<i>Common properties of components</i>	140
<i>ComboBox properties of components</i>	140
<i>DataGridView properties</i>	141
<i>DataBindings</i>	143
<i>DataSource</i>	143
<i>DataTarget</i>	144
<i>Saving the DC wizard template in StepDesigner</i>	146
<i>Deploying a template file</i>	147
<i>Localizing service report templates</i>	147

Creating a template for Drive Installed Base service report (Internal use only)

Note: Service report templates are created by authorized ABB personnel only. If you need to create template, contact your local ABB representative.

You can create a template file for Drive Installed Base service report using the Step Designer tool. You will need necessary permissions to access the tool. The tool has different steps (see page 139) and components (see page 139), but not all of them are used in the Drive Installed Base service reporting template.

The project file (*SDDIBTemplate.xml*) is located in the Drive Installed Base service portal. The file contains all currently supported components and databindings (see page 143). See descriptions in below sections.

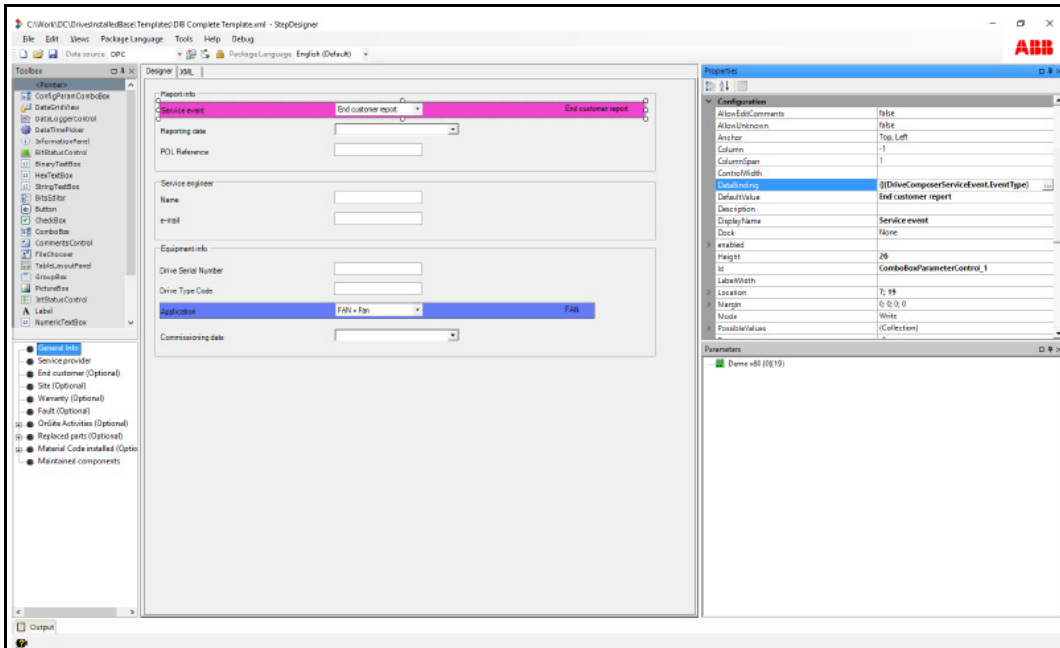

The example screens show General Information for service actions.

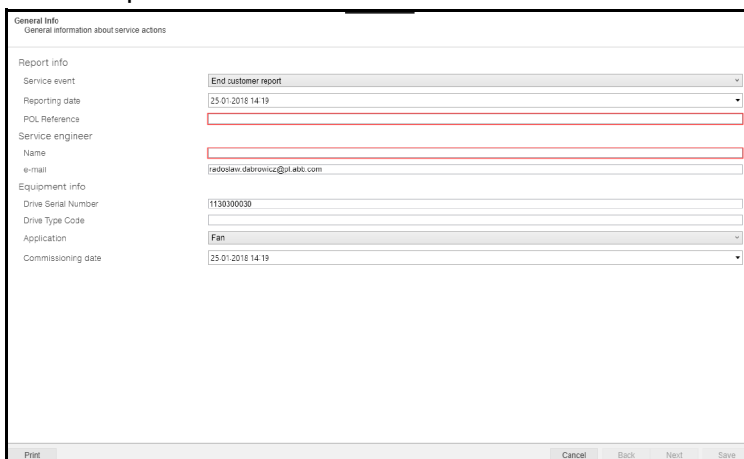

Generic wizard step

The Generic wizard step is used in the Drive Installed Base template structure. Currently, the template supports only this step.

The table below lists the sections and properties of the Generic wizard step used in the Drive Installed Base service report.

Section	Property	Comment
Configuration	Display Name (presented as "Title" in Drive Installed Base service report)	Mandatory to fill this value.
	Description	Appears below "Title"
DC Wizard Printing	AddToReport	Determines that page is visible on print preview.

Components

The table below lists the components used in Drive Installed Base service reports.

Component	Presented as ...
CommentsControl	multiline text component
NumericTextBox	numeric component Note: Accepts numeric values only.
CheckBox, ThreeStateCheckBox	checkbox
TextBox, BinaryTextBox, StringTextBox, HexTextBox	one-line text components
Filechooser	user file selectable component
ComboBox	drop-down list
DataGridView	table

■ **Common properties of components**

The following properties are common for the components defined in Drive Installed Base service report.

Section	Property	Comment
Configuration	DataBinding	Defines data input and output of the component. See also DataBinding xx.
	DefaultValue	Defines default value of the component. This value is used if source databinding is not defined.
	Display Name	Appears as "Title" in service report. This is a mandatory value.
	enabled (value)	Defines that component is read-only
	enabled (expression)	Not supported
	ValueRequired	Defines if value must be filled. True = Value is required before navigating to the next page. False = Value is not required
DC Wizard Printing	AddToReport	Determines the print preview of service report page.
	BlankLineAfter	Adds one empty line in print report after this component.
	OmitIfEmpty	Does not print the component if there is no value.
	PageBreakAfter	Adds page break in print report after this component.

■ **ComboBox properties of components**

You can use the following combo box property to define the components in Drive Installed Base service report.

Property	Comment
PossibleValues (value)	Shows values in the drop down list. Selecting a value opens a new editor. You can add, change or remove a value. See example screen below. In the new editor, you can define name and value of the property. Data in the Value field is sent to Drive Installed Base service. Make sure that this data is synchronized with the expected data value.
PossibleValues (expression)	Not supported

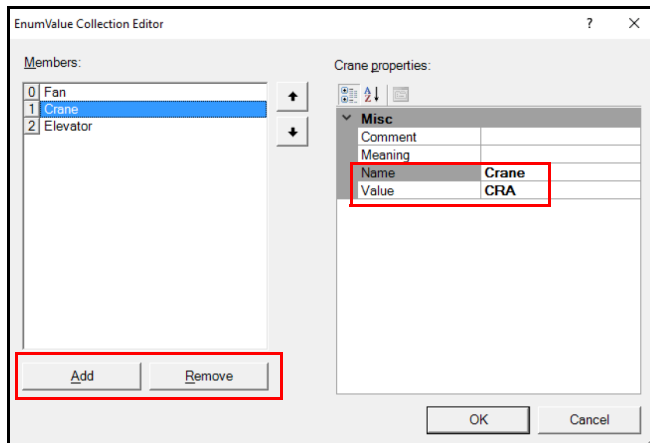

■ DataGridView properties

You can use the following data grid view property to define components in Drive Installed Base service report.

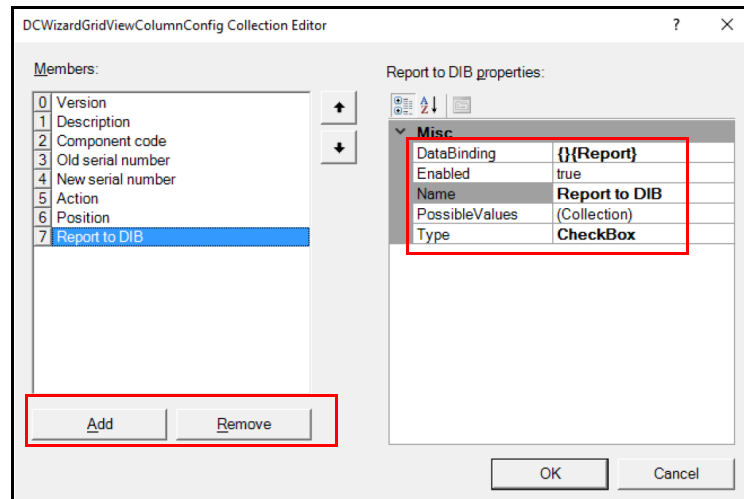

Property	Comment												
DCWizardColumns	<p>Defines columns in the table. Selecting a column value opens a new editor. You can add, change or remove a column value. See example screen below.</p> <p>In the new editor, you can define the column properties:</p>												
	<table border="1"> <thead> <tr> <th data-bbox="395 466 650 519">Column property</th> <th data-bbox="650 466 1276 519">Comment</th> </tr> </thead> <tbody> <tr> <td data-bbox="395 519 650 603">DataBinding</td> <td data-bbox="650 519 1276 603">Defines data input and output. See also DataBindings (page 143).</td> </tr> <tr> <td data-bbox="395 603 650 656">Enabled</td> <td data-bbox="650 603 1276 656">Enables read-only column mode.</td> </tr> <tr> <td data-bbox="395 656 650 710">Name</td> <td data-bbox="650 656 1276 710">Defines column header text.</td> </tr> <tr> <td data-bbox="395 710 650 869">PossibleValue</td> <td data-bbox="650 710 1276 869"> Defines possible values if column type is DropDown. Note: This property is not supported for other column types. </td> </tr> <tr> <td data-bbox="395 869 650 948">Type</td> <td data-bbox="650 869 1276 948">Defines following data types: String, Numeric, Date, CheckBox, DropDown</td> </tr> </tbody> </table>	Column property	Comment	DataBinding	Defines data input and output. See also DataBindings (page 143).	Enabled	Enables read-only column mode.	Name	Defines column header text.	PossibleValue	Defines possible values if column type is DropDown. Note: This property is not supported for other column types.	Type	Defines following data types: String, Numeric, Date, CheckBox, DropDown
	Column property	Comment											
	DataBinding	Defines data input and output. See also DataBindings (page 143).											
	Enabled	Enables read-only column mode.											
	Name	Defines column header text.											
	PossibleValue	Defines possible values if column type is DropDown. Note: This property is not supported for other column types.											
Type	Defines following data types: String, Numeric, Date, CheckBox, DropDown												
<p>Note: Columns defined are not visible in StepDesigner, but are visible only in Drive Installed Base service report wizard.</p>													

DataBindings

DataBindings define how to fill the component with data and to where the filled data must be sent. The Drive Installed Base service report includes two types of DataBinding properties:

- [DataSource](#)
- [DataTarget](#)

You can fill the properties using existing DataBinding properties in the StepDesigner tool. See the sample format below:

```
"{DataSourceBinding}{DataTargetBinding}"
```

The format is converted to:

```
DataSource = "DataSourceBinding"
```

```
DataTarget = "DataTargetBinding"
```

If value in "DataBinding" does not match with the previous format, the value is assigned to "DataSource" property and "DataTarget" remains empty.

■ DataSource

DataSource is a DataBinding property that defines how component data must be filled if you started the service report wizard for the first time and default value was empty.

See the data source list supported by Drive Composer PC tool:

Property	Comment
DateTimeNow	Defines current date
Par.G.I	Drive parameter group and index. For example, Par.1.11, means that Drive Composer reads value from parameter group 1 and index 11 of the selected drive.
Info.ID	System info ID number or drive info defined by ID. For example, Info.1, means that Drive Composer reads drive serial number.
UserEmail	Email ID of user logged in to Drive Installed Base service.
Drive	Data object received from Drive Installed Base service. For example, Drive.SerialNumber —reads drive serial number Drive.EndCustomer.Name —reads end customer name Drive.Site.StreetAddress —reads site address where the drive is installed

Property	Comment
Component	<p>Drive components for table data. Each column has an appropriate component type property as its DataSource. See below example code:</p> <pre data-bbox="352 349 1235 754"> <Components> <Component c:type="CfrTable" id="DataGridView_1" dataBinding="{Component}{}"> <DCWizardColumns> <Column name="Version" databinding="{Version}{}" type="String" enabled="true" /> <Column name="Description" databinding="{Description}{}" type="String" enabled="true" /> </DCWizardColumns> </Component> </pre> <ul data-bbox="352 769 1235 909" style="list-style-type: none"> • Each row fills with a component property • The column name Version reads data from Component.Version property • The column name Description reads value from Component.Description property.

■ DataTarget

DataTarget is a DataBinding property that defines how to send value of current component to Drive Installed Base service. Drive Composer sends the value to multiple object types of Drive Installed Base service.

DataTarget objects

The table below list the objects created based on DataTarget definitions:

Object	Subtypes
DriveComposerServiceEvent	<ul style="list-style-type: none"> ServiceEventWarranty ServiceEventFault Collection of objects of ServiceEventReplacedPart type ServiceEventSite ServiceEventEndCustomer ServiceEventFieldServiceEngineer Collection of objects of MaterialCodeInstalled type ServiceEventServiceProvider OnSiteActivities <ul style="list-style-type: none"> • Commissioning • Collection of Fault type objects • Collection of Attachment type objects
MaintainedComponent (collection of objects)	-

DataTarget examples

If DataTarget =...	Value fills this property
<i>DriveComposerServiceEvent.SerialNumber</i>	<i>SerialNumber</i> in object type <i>DriveComposerServiceEvent</i>
<i>ServiceEventEndCustomer.Name</i>	<i>Name</i> in object type <i>ServiceEventEndCustomer</i> , which is defined as property <i>EndCustomer</i> in object type <i>DriveComposerServiceEvent</i>
<i>ServiceEventWarranty.ResponsibleUnit</i>	<i>ResponsibleUnit</i> in object type <i>ServiceEventWarranty</i> , which is defined as property <i>Warranty</i> in object type <i>DriveComposerServiceEvent</i>

The objects defined as collection, use the DataTarget in two ways:

Fault.Code—value from this component fills property *Code* in object type *Fault*. If you added more than one component, Drive Composer sends only the value of first component in the page to Drive Installed Base service.

Fault.Code|1...3—based on components with three different bindings three objects of *Fault* type are created. You can define more than one collection element on one page.

Saving the DC wizard template in StepDesigner

After you designed a service report template with the StepDesigner tool using components, databindings, etc., save the template file to Drive Composer reporting wizard format (.dcwiz) and set the file as custom printing template file format (.xaml). The custom printing template defines the common appearance of printed pages like header, footer, etc.

To save the template file,

1. In StepDesigner, go to **File** → **Save DC Wizard template**.

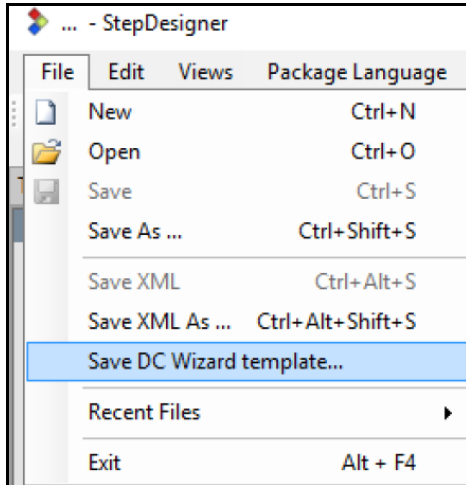

Figure 225. Save DC Wizard template

The file is saved in .dcwiz format.

2. Click **Yes**, to set the file as custom printing template file (.xaml format) or click **No**, to use the default printing template.

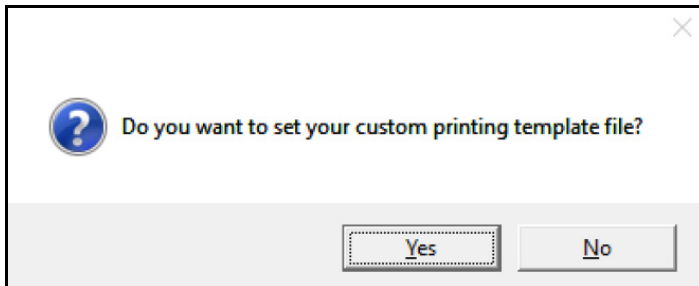

Figure 226. Set custom printing template

Note:

- The template must contain a *ContentControl* named "cc".
- ABB recommends that you use the same name for both files for better identification.

Deploying a template file

The Service reporting (`create_service_report.html`) module contains all service report template files. You can see a range of entries in the Select service type list. Each entry refers to a template file.

To deploy a template file,

1. Create a template structure in StepDesigner tool. See [Creating a template for Drive Installed Base service report \(Internal use only\)](#) on page 138.
2. Save the file to StepDesigner format.
3. Create a `.dcwiz` file. See steps for [Saving the DC wizard template in StepDesigner](#). ABB recommends that you use the same name for both files for better identification.
4. If you have multiple templates, repeat steps 1...3.
5. Create a zip file of the multiple files.
6. Upload the zip file to Drive Installed Base service portal. If you do not have the necessary permissions, you can request the Drive Installed Base team to upload the files.

Localizing service report templates

Consider the following points,

- Whenever you change the language settings in Drive Composer, see the localized templates list in service types of Service reporting (`create_service_report.html`) module.
- Language files are recognized by their file names. For example,
 - `File.dcwiz` or `File_en.dcwiz` refers to English template file.
 - `File_pl.dcwiz` refers to Polish template file.
 - `File_fi.dcwiz` refers to Finnish template file.
- When you selected a language, all properties (Display Name, Description, Name, etc.) are translated to their respective languages.
- When you selected a language, the files matching that language selection are only visible. If a particular language file does not exist, then English version is displayed as default.

Example:

The below example cases show the list of files visible when you selected a language. The template file is a zip file of following files.

- `File.dcwiz`
- `SecondFile.dcwiz`
- `ThirdFile_en.dcwiz`
- `File_fi.dcwiz`
- `FourthFile_fi.dcwiz`

Case	If language selected is...	The Select service type dropdown lists the following files:
Case 1	English	<ul style="list-style-type: none"> • File • SecondFile • ThirdFile_en

Case	If language selected is...	The Select service type dropdown lists the following files:
Case 2	Finnish	<ul style="list-style-type: none">• File_fi• SecondFile• ThirdFile_en• FourthFile_fi



Annexure B: Radius authentication

Contents of this chapter

This chapter describes any additional information needed for Radius authentication.

See topics:

<i>Example: Network configurations via Ethernet connection</i>	230
<i>ABB vendor specific attribute</i>	231
<i>Supported user access levels</i>	231
<i>Offline credentials</i>	231
<i>Default credentials:</i>	231

Example: Network configurations via Ethernet connection

The table below lists the possible Ethernet configurations for Radius server authentication. See also [RADIUS authentication](#) (page 211).

Connection type	Description
<p>Single drive - single server</p>	<p>Drive Composer PC tool is connected to a drive which is connected to the Radius server.</p> 
<p>Multiple drives - single server (Recommended)</p>	<p>Drive Composer PC tool is connected to multiple drives via router and each drive is connected to a single instance of Radius server, thus each drive has the same set of users, who can authenticate.</p> 
<p>Multiple drives - multiple servers</p>	<p>Drive Composer PC tool is connected to multiple drives via a router and each drive is connected to a separate instance of Radius server. This type of connection may cluster accessibility, and thus administration of drives and user credentials needs to be handled with care when settings are changed. It is also possible to have different set of authentication credentials in separate instances of Radius servers, which may allow login to all drives, or just to some drives.</p> 
<p>Multiple drives - multiple servers with load balancer</p>	<p>With Multiple drives - multiple servers connection (see in above row), there may be instances of server failure, for example, due to multiple requests at the same time. This kind of fault occurrences or server load can be overcome using a load balancer. For example, when the Radius server receives multiple requests, and if the first instance fails, then the second instance is activated automatically and allows to login.</p> 

ABB vendor specific attribute

Each user's access level defined by the Radius server is based on the ABB vendor specific attribute defined for vendor id: 43194. The attribute contains one sub-attribute (id 1) containing a numeric value (uint32) defining the user access level. If this user access level is missing from the Radius server, drive will ignore the response as invalid.

The vendor specific attributes are defined based on the used Radius server and how it is configured. For more information, see the Radius server manual.

■ Supported user access levels

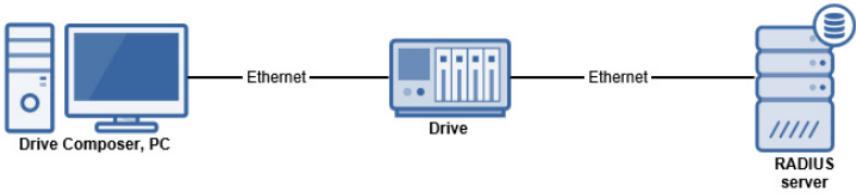
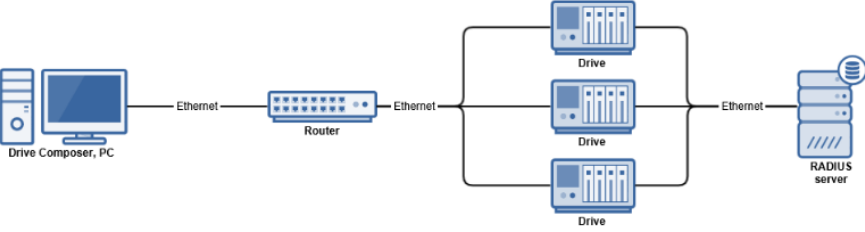
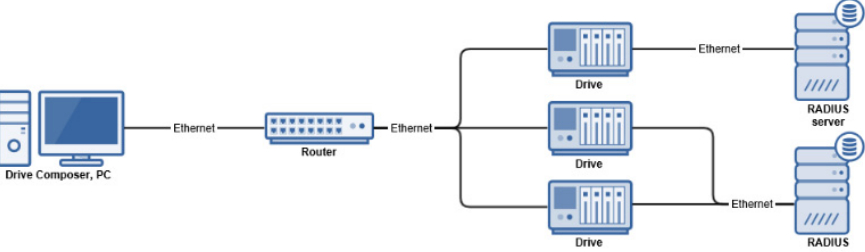
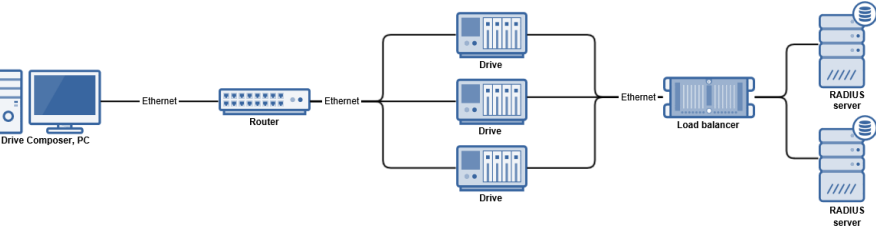
Value	Type	Description
0	None	User is defined in the Radius server, but login is disabled.
100	Basic	Login allowed, but cannot reconfigure Radius settings.
200	Service	Allows login and can change Radius settings using Drive Composer.

You cannot login with any other user access levels other than the above list. For more information about ABB vendor specific attribute, see Drives Wikipage.

Offline credentials

Offline credentials are used to connect to drives when the drive is not able to connect to the Radius authentication server.

Offline authentication is enabled only when:

- Radius authentication is enabled and Radius server configuration is valid in drive settings.
- Drive is able to send Radius Access-Request to Radius server without errors.
- Radius server does not respond at all (within the receive timeout of the drive).

By default the drive has at least one offline user credential to allow offline authentication. The offline credentials are defined in an XML format. For access to the XML file, contact your local ABB representative.

■ Default credentials:

User name = *localuser*

Password = *localpassword*

User access level = *Service*

You can redefine the offline user credentials via Drive Composer. Go to **View** → **Settings** → **Radius config**.

Note:

- There may be limitations in the length of username and password. Follow the standard regulations.
- If the encoded output file cannot be read by drive, drive will discard it and use the default offline credentials defined in the drive.



Further information

Product and service inquiries

Address any inquiries about the product to your local ABB representative, quoting the type designation and serial number of the unit in question. A listing of ABB sales, support and service contacts can be found by navigating to abb.com/searchchannels.

Product training

For information on ABB product training, navigate to new.abb.com/service/training.

Providing feedback on ABB Drives manuals

Your comments on our manuals are welcome. Navigate to new.abb.com/drives/manuals-feedback-form.

Document library on the Internet

You can find manuals and other product documents in PDF format on the Internet at abb.com/drives/documents.



abb.com/drives